

Programmable controllers —

Part 3: Programming languages

<http://www.china-gauges.com/>

The European Standard EN 61161-3:2003 has the status of a
British Standard

ICS 25.040; 35.240.50

National foreword

This British Standard is the official English language version of EN 61131-3:2003. It is identical with IEC 61131-3:2003. It supersedes BS EN 61131-3:1993 which is withdrawn.

The UK participation in its preparation was entrusted by Technical Committee GEL/65, Measurement and control, to Subcommittee GEL/65/2, Elements of systems, which has the responsibility to:

- aid enquirers to understand the text;
- present to the responsible international or European committee any enquiries on the interpretation of the proposals for change, and keep the UK interests informed;
- monitor related international and European developments and promulgate them in the UK.

A list of organizations represented on this subcommittee can be obtained on request to its secretary.

Cross-references

The British Standards which implement international or European publications referred to in this document may be found in the *BSI Catalogue* under the section entitled "International Standards Correspondence Index", or by using the "Search" facility of the *BSI Electronic Catalogue* or of British Standards Online.

This publication does not purport to include all the necessary provisions of a contract. Users are responsible for its correct application.

Compliance with a British Standard does not of itself confer immunity from legal obligations.

Summary of pages

This document comprises a front cover, an inside front cover, the EN title page, pages 2 to 219, an inside back cover and a back cover.

The BSI copyright date displayed in this document indicates when the document was last issued.

Amendments issued since publication

Amd. No.	Date	Comments

This British Standard was published under the authority of the Standards Policy and Strategy Committee on 16 June 2003

© BSI 16 June 2003

ISBN 0 580 42021 3

EUROPEAN STANDARD

EN 61131-3

NORME EUROPÉENNE

EUROPÄISCHE NORM

March 2003

ICS 25.040; 35.240.50

Supersedes EN 61131-3:1993

English version

Programmable controllers
Part 3: Programming languages
(IEC 61131-3:2003)

Automates programmables
Partie 3: Langues de programmation
(CEI 61131-3:2003)

Speicherprogrammierbare Steuerungen
Teil 3: Programmiersprachen
(IEC 61131-3:2003)

This European Standard was approved by CENELEC on 2002-12-01. CENELEC members are bound to comply with the CEN/CENELEC Internal Regulations which stipulate the conditions for giving this European Standard the status of a national standard without any alteration.

Up-to-date lists and bibliographical references concerning such national standards may be obtained on application to the Central Secretariat or to any CENELEC member.

This European Standard exists in three official versions (English, French, German). A version in any other language made by translation under the responsibility of a CENELEC member into its own language and notified to the Central Secretariat has the same status as the official versions.

CENELEC members are the national electrotechnical committees of Austria, Belgium, Czech Republic, Denmark, Finland, France, Germany, Greece, Hungary, Iceland, Ireland, Italy, Luxembourg, Malta, Netherlands, Norway, Portugal, Slovakia, Spain, Sweden, Switzerland and United Kingdom.

CENELEC

European Committee for Electrotechnical Standardization
Comité Européen de Normalisation Electrotechnique
Europäisches Komitee für Elektrotechnische Normung

Central Secretariat: rue de Stassart 35, B - 1050 Brussels

Foreword

The text of document 65B/456/FDIS, future edition 2 of IEC 61131-3, prepared by SC 65B, Devices, of IEC TC 65, Industrial-process measurement and control, was submitted to the IEC-CENELEC parallel vote and was approved by CENELEC as EN 61131-3 on 2002-12-01.

This European Standard supersedes EN 61131-3:1993.

The following dates were fixed:

- latest date by which the EN has to be implemented at national level by publication of an identical national standard or by endorsement (dop) 2003-10-01
- latest date by which the national standards conflicting with the EN have to be withdrawn (dow) 2005-12-01

Annexes designated "normative" are part of the body of the standard.

Annexes designated "informative" are given for information only.

In this standard, annexes A, B, C, D, E and ZA are normative and annexes F and G are informative.

Annex ZA has been added by CENELEC.

Endorsement notice

The text of the International Standard IEC 61131-3:2003 was approved by CENELEC as a European Standard without any modification.

<http://www.china-gauges.com/>

CONTENTS

1	General	6
1.1	Scope	9
1.2	Normative references	9
1.3	Definitions	9
1.4	Overview and general requirements	14
1.4.1	Software model	14
1.4.2	Communication model	16
1.4.3	Programming model	18
1.5	Compliance	19
1.5.1	System compliance	20
1.5.2	Program compliance	22
2	Common elements	22
2.1	Use of printed characters	22
2.1.1	Character set	22
2.1.2	Identifiers	23
2.1.3	Keywords	23
2.1.4	Use of white space	23
2.1.5	Comments	24
2.1.6	Pragmas	24
2.2	External representation of data	24
2.2.1	Numeric literals	24
2.2.2	Character string literals	25
2.2.3	Time literals	27
2.2.3.1	Duration	27
2.2.3.2	Time of day and date	28
2.3	Data types	28
2.3.1	Elementary data types	29
2.3.2	Generic data types	30
2.3.3	Derived data types	31
2.3.3.1	Declaration	31
2.3.3.2	Initialization	32
2.3.3.3	Usage	34
2.4	Variables	35
2.4.1	Representation	35
2.4.1.1	Single-element variables	35
2.4.1.2	Multi-element variables	37
2.4.2	Initialization	37
2.4.3	Declaration	38
2.4.3.1	Type assignment	40
2.4.3.2	Initial value assignment	41
2.5	Program organization units	44
2.5.1	Functions	44
2.5.1.1	Representation	45
2.5.1.2	Execution control	48
2.5.1.3	Declaration	49
2.5.1.4	Typing, overloading, and type conversion	51
2.5.1.5	Standard functions	54
2.5.1.5.1	Type conversion functions	54
2.5.1.5.2	Numerical functions	55
2.5.1.5.3	Bit string functions	58
2.5.1.5.4	Selection and comparison functions	58
2.5.1.5.5	Character string functions	61
2.5.1.5.6	Functions of time data types	63
2.5.1.5.7	Functions of enumerated data types	65

<http://www.china-gauges.com/>

2.5.2	Function blocks	65
2.5.2.1	Representation	66
2.5.2.1a)	Use of EN and ENO in function blocks	67
2.5.2.2	Declaration	68
2.5.2.3	Standard function blocks	69
2.5.2.3.1	Bistable elements	76
2.5.2.3.2	Edge detection	77
2.5.2.3.3	Counters	77
2.5.2.3.4	Timers	80
2.5.2.3.5	Communication function blocks	82
2.5.3	Programs	82
2.6	Sequential Function Chart (SFC) elements	83
2.6.1	General	83
2.6.2	Steps	83
2.6.3	Transitions	85
2.6.4	Actions	88
2.6.4.1	Declaration	88
2.6.4.2	Association with steps	90
2.6.4.3	Action blocks	91
2.6.4.4	Action qualifiers	92
2.6.4.5	Action control	93
2.6.5	Rules of evolution	98
2.6.6	Compatibility of SFC elements	106
2.6.7	SFC Compliance requirements	107
2.7	Configuration elements	107
2.7.1	Configurations, resources, and access paths	109
2.7.2	Tasks	113
3	Textual languages	122
3.1	Common elements	122
3.2	Instruction list (IL)	122
3.2.1	Instructions	122
3.2.2	Operators, modifiers and operands	123
3.2.3	Functions and function blocks	125
3.3	Structured Text (ST)	128
3.3.1	Expressions	128
3.3.2	Statements	130
3.3.2.1	Assignment statements	132
3.3.2.2	Function and function block control statements	132
3.3.2.3	Selection statements	132
3.3.2.4	Iteration statements	133
4	Graphic languages	134
4.1	Common elements	134
4.1.1	Representation of lines and blocks	134
4.1.2	Direction of flow in networks	134
4.1.3	Evaluation of networks	135
4.1.4	Execution control elements	137
4.2	Ladder diagram (LD)	138
4.2.1	Power rails	138
4.2.2	Link elements and states	138
4.2.3	Contacts	139
4.2.4	Coils	139
4.2.5	Functions and function blocks	139
4.2.6	Order of network evaluation	140
4.3	Function Block Diagram (FBD)	142
4.3.1	General	142
4.3.2	Combination of elements	142
4.3.3	Order of network evaluation	142

<http://www.china-gauges.com/>

ANNEX A (normative) Specification method for textual languages	143
A.1 Syntax	143
A.1.1 Terminal symbols	143
A.1.2 Non-terminal symbols	143
A.1.3 Production rules	144
A.2 Semantics	144
ANNEX B (normative) Formal specifications of language elements	145
B.0 Programming model	145
B.1 Common elements	145
B.1.1 Letters, digits and identifiers	145
B.1.2 Constants	146
B.1.2.1 Numeric literals	146
B.1.2.2 Character strings	146
B.1.2.3 Time literals	147
B.1.2.3.1 Duration	147
B.1.2.3.2 Time of day and date	147
B.1.3 Data types	148
B.1.3.1 Elementary data types	148
B.1.3.2 Generic data types	148
B.1.3.3 Derived data types	148
B.1.4 Variables	150
B.1.4.1 Directly represented variables	150
B.1.4.2 Multi-element variables	150
B.1.4.3 Declaration and initialization	151
B.1.5 Program organization units	153
B.1.5.1 Functions	153
B.1.5.2 Function blocks	154
B.1.5.3 Programs	155
B.1.6 Sequential function chart elements	155
B.1.7 Configuration elements	156
B.2 Language IL (Instruction List)	158
B.2.1 Instructions and operands	158
B.2.2 Operators	158
B.3 Language ST (Structured Text)	159
B.3.1 Expressions	159
B.3.2 Statements	159
B.3.2.1 Assignment statements	160
B.3.2.2 Subprogram control statements	160
B.3.2.3 Selection statements	160
B.3.2.4 Iteration statements	160
ANNEX C (normative) Delimiters and keywords	161
ANNEX D (normative) Implementation-dependent parameters	164
ANNEX E (normative) Error conditions	166
ANNEX F (informative) Examples	168
F.1 Function WEIGH	168
F.2 Function block CMD_MONITOR	169
F.3 Function block FWD_REV_MON	172
F.4 Function block STACK_INT	177
F.5 Function block MIX_2_BRIX	182
F.6 Analog signal processing	185
F.6.1 Function block LAG1	186
F.6.2 Function block DELAY	186

<http://www.china-gauges.com/>

F.6.3 Function block AVERAGE	187
F.6.4 Function block INTEGRAL	187
F.6.5 Function block DERIVATIVE	188
F.6.6 Function block HYSTERESIS	188
F.6.7 Function block LIMITS_ALARM	189
F.6.8 Structure ANALOG_LIMITS	189
F.6.9 Function block ANALOG_MONITOR	190
F.6.10 Function block PID	191
F.6.11 Function block DIFFEQ	192
F.6.12 Function block RAMP	193
F.6.13 Function block TRANSFER	194
F.7 Program GRAVEL	194
F.8 Program AGV	202
F.9 Use of enumerated data types	205
F.10 Function block RTC (Real Time Clock)	205
F.11 Function block ALRM_	205
ANNEX G (informative) Reference character set	207
Annex ZA (normative) Normative references to international publications with their corresponding European publications	209
Index	210
Table 1 - Character set features	22
Table 2 - Identifier features	23
Table 3 - Comment feature	24
Table 3a - Pragma feature	24
Table 4 - Numeric literals	25
Table 5 - Character string literal features	26
Table 6 - Two-character combinations in character strings	27
Table 7 - Duration literal features	28
Table 8 - Date and time of day literals	28
Table 9 - Examples of date and time of day literals	28
Table 10 - Elementary data types	29
Table 11 - Hierarchy of generic data types	31
Table 12 - Data type declaration features	32
Table 13 - Default initial values of elementary data types	33
Table 14 - Data type initial value declaration features	34
Table 15 - Location and size prefix features for directly represented variables	36
Table 16a - Variable declaration keywords	38
Table 16b - Usages of VAR_GLOBAL, VAR_EXTERNAL and CONSTANT declarations	40
Table 17 - Variable type assignment features	40
Table 18 - Variable initial value assignment features	42
Table 19 - Graphical negation of Boolean signals	46
Table 19a - Textual invocation of functions for formal and non-formal argument list	48
Table 20 - Use of EN input and ENO output	49
Table 20a - Function features	50
Table 21 - Typed and overloaded functions	52
Table 22 - Type conversion function features	54

<http://www.china-gauges.com/>

Table 23 - Standard functions of one numeric variable.....	56
Table 24 - Standard arithmetic functions.....	57
Table 25 - Standard bit shift functions.....	58
Table 26 - Standard bitwise Boolean functions.....	59
Table 27 - Standard selection functions ^d	60
Table 28 - Standard comparison functions.....	61
Table 29 - Standard character string functions.....	62
Table 30 - Functions of time data types.....	63
Table 31 - Functions of enumerated data types.....	65
Table 32 - Examples of function block I/O variable usage.....	67
Table 33 - Function block declaration and usage features.....	70
Table 34 - Standard bistable function blocks ^a	76
Table 35 - Standard edge detection function blocks.....	77
Table 36 - Standard counter function blocks.....	78
Table 37 - Standard timer function blocks.....	80
Table 38 - Standard timer function blocks - timing diagrams.....	81
Table 39 - Program declaration features.....	82
Table 40 - Step features.....	84
Table 41 - Transitions and transition conditions.....	86
Table 42 - Declaration of actions ^{a,b}	89
Table 43 - Step/action association.....	91
Table 44 - Action block features.....	92
Table 45 - Action qualifiers.....	93
Table 45a - Action control features.....	97
Table 46 - Sequence evolution.....	100
Table 47 - Compatible SFC features.....	107
Table 48 - SFC minimal compliance requirements.....	107
Table 49 - Configuration and resource declaration features.....	111
Table 50 - Task features.....	115
Table 51a - Examples of instruction fields.....	123
Table 51b - Parenthesized expression features for IL language.....	124
Table 52 - Instruction List operators.....	124
Table 53 - Function Block invocation and Function invocation features for IL language.....	126
Table 54 - Standard Function Block input operators for IL language.....	128
Table 55 - Operators of the ST language.....	130
Table 56 - ST language statements.....	131
Table 57 - Representation of lines and blocks.....	135
Table 58 - Graphic execution control elements.....	137
Table 59 - Power rails.....	138
Table 60 - Link elements.....	139
Table 61 - Contacts ^a	140
Table 62 - Coils.....	141
Table C.1 - Delimiters.....	161
Table C.2 - Keywords.....	162
Table D.1 - Implementation-dependent parameters.....	164
Table E.1 - Error conditions.....	166

<http://www.china-gauges.com/>

Table G.1 - Character representations	207
Table G.2 - Character encodings	208
Figure 1 - Software model	15
Figure 2 a) - Data flow connection within a program	16
Figure 2 b) - Communication via GLOBAL variables	16
Figure 2 c) - Communication function blocks	17
Figure 2 d) - Communication via access paths	17
Figure 3 - Combination of programmable controller language elements	19
Figure 4 - Examples of function usage	44
Figure 5 - Use of formal argument names	47
Figure 6 - Examples of function declarations and usage	51
Figure 7 - Examples of explicit type conversion with overloaded functions	53
Figure 8 - Examples of explicit type conversion with typed functions	53
Figure 9 - Function block instantiation examples	66
Figure 10 - Examples of function block declarations	69
Figure 11 a) - Graphical use of a function block name as an input variable	72
Figure 11 b) - Graphical use of a function block name as an in-out variable	73
Figure 11 c) - Graphical use of a function block name as an external variable	74
Figure 12 - Declaration and usage of in-out variables in function blocks	75
Figure 14 - ACTION_CONTROL function block - External interface (Not visible to the user)	94
Figure 15 a) - ACTION_CONTROL function block body with "final scan" logic	95
Figure 15 b) - ACTION_CONTROL function block body without "final scan" logic	96
Figure 16 a) - Action control example - SFC representation	97
Figure 16 b) - Action control example - functional equivalent	98
Figure 17 - Examples of SFC evolution rules	104
Figure 18 a) - Examples of SFC errors: an "unsafe" SFC	105
Figure 18 b) - Examples of SFC errors: an "unreachable" SFC	106
Figure 19 a) - Graphical example of a configuration	108
Figure 19 b) - Skeleton function block and program declarations for configuration example	109
Figure 20 - Examples of CONFIGURATION and RESOURCE declaration features	112
Figure 21 a) - Synchronization of function blocks with explicit task associations	119
Figure 21 b) - Synchronization of function blocks with implicit task associations	120
Figure 21 c) - Explicit task associations equivalent to figure 21 b)	121
Figure 22 - EXIT statement example	133
Figure 23 - Feedback path example	136
Figure 24 - Boolean OR examples	142

<http://www.china-gauges.com/>

PROGRAMMABLE CONTROLLERS –

Part 3: Programming languages

1 General

1.1 Scope

This part of IEC 61131 specifies syntax and semantics of programming languages for *programmable controllers* as defined in part 1 of IEC 61131.

The functions of program entry, testing, monitoring, operating system, etc., are specified in Part 1 of IEC 61131.

1.2 Normative references

The following referenced documents are indispensable for the application of this document. For dated references, only the edition cited applies. For undated references, the latest edition of the referenced document (including any amendments) applies.

IEC 60050 (all parts): *International Electrotechnical Vocabulary (IEV)*

IEC 60559:1989, *Binary floating-point arithmetic for microprocessors systems*

IEC 60617-12:1997, *Graphical symbols for diagrams – Part 12: Binary logic elements*

IEC 60617-13:1993, *Graphical symbols for diagrams – Part 13: Analogue elements*

IEC 60848:2002, *GRAFNET specification language for sequential function charts*

IEC 61131-1, *Programmable controllers – Part 1: General information*

IEC 61131-5, *Programmable controllers – Part 5: Communications*

ISO/AFNOR: 1989, *Dictionary of computer science – The standardised vocabulary*

ISO/IEC 10646-1:1993, *Information technology – Universal Multiple-Octet Coded Character Set (UCS) – Part 1: Architecture and Basic Multilingual Plane*

1.3 Definitions

For the purposes of this part of IEC 61131, the following definitions apply. Definitions applying to all parts of IEC 61131 are given in part 1.

NOTE 1 Terms defined in this subclause are *italicized* where they appear in the bodies of definitions.

NOTE 2 The notation “(ISO)” following a definition indicates that the definition is taken from the ISO/AFNOR Dictionary of computer science.

NOTE 3 The ISO/AFNOR Dictionary of computer science and the IEC 60050 should be consulted for terms not defined in this standard.

<http://www.china-gauges.com/>

- 1.3.1 absolute time:** the combination of time of day and date information.
- 1.3.2 access path:** the association of a symbolic name with a variable for the purpose of open communication.
- 1.3.3 action:** Boolean variable, or a collection of operations to be performed, together with an associated control structure, as specified in 2.6.4.
- 1.3.4 action block:** graphical language element which utilizes a Boolean input variable to determine the value of a Boolean output variable or the enabling condition for an *action*, according to a predetermined control structure as defined in 2.6.4.5.
- 1.3.5 aggregate:** structured collection of data objects forming a *data type*. (ISO)
- 1.3.6 argument:** synonymous with *input variable*, *output variable* or *in-out variable*.
- 1.3.7 array:** *aggregate* that consists of data objects, with identical attributes, each of which may be uniquely referenced by *subscripting*. (ISO)
- 1.3.8 assignment:** mechanism to give a value to a variable or to an *aggregate*. (ISO)
- 1.3.9 based number:** number represented in a specified base other than ten.
- 1.3.10 bistable function block:** *function block* with two stable states controlled by one or more inputs.
- 1.3.11 bit string:** data element consisting of one or more bits.
- 1.3.12 body:** that portion of a *program organization unit* which specifies the operations to be performed on the declared *operands* of the program organization unit when its execution is *invoked*.
- 1.3.13 call:** language construct for *invoking* the execution of a *function* or *function block*.
- 1.3.14 character string:** *aggregate* that consists of an ordered sequence of characters.
- 1.3.15 comment:** language construct for the inclusion of text in a program and having no impact on the execution of the program. (ISO)
- 1.3.16 compile:** to translate a *program organization unit* or *data type* specification into its machine language equivalent or an intermediate form.
- 1.3.17 configuration:** language element corresponding to a *programmable controller system* as defined in IEC 61131-1.
- 1.3.18 counter function block:** *function block* which accumulates a value for the number of changes sensed at one or more specified *inputs*.
- 1.3.19 data type:** set of values together with a set of permitted operations. (ISO)
- 1.3.20 date and time:** the date within the year and the time of day represented as a single language element.
- 1.3.21 declaration:** the mechanism for establishing the definition of a *language element*. A declaration normally involves attaching an identifier to the language element, and allocating attributes such as *data types* and algorithms to it.

<http://www.china-gauges.com/>

1.3.22 delimiter: character or combination of characters used to separate program *language elements*.

1.3.23 direct representation: means of representing a variable in a programmable controller program from which a manufacturer-specified correspondence to a physical or *logical location* may be determined directly.

1.3.24 double word: data element containing 32 bits.

1.3.25 evaluation: the process of establishing a value for an expression or a *function*, or for the *outputs* of a network or *function block*, during program execution.

1.3.26 execution control element: A *language element* which controls the flow of program execution.

1.3.27 falling edge: the change from 1 to 0 of a Boolean variable.

1.3.28 function (procedure): *program organization unit* which, when executed, yields exactly one data element and possibly additional *output variables* (which may be multi-valued, for example, an *array* or *structure*), and whose *invocation* can be used in textual languages as an *operand* in an expression.

1.3.29 function block instance (function block): *instance of a function block type*.

1.3.30 function block type: programmable controller programming *language element* consisting of:

- 1) the definition of a data structure partitioned into input, output, and internal variables; and
- 2) a set of operations to be performed upon the elements of the data structure when an *instance* of the function block type is *invoked*.

1.3.31 function block diagram: *network* in which the nodes are *function block instances*, graphically represented *functions (procedures)*, *variables*, *literals*, and *labels*.

1.3.32 generic data type: *data type* which represents more than one type of data, as specified in 2.3.2.

1.3.33 global scope: scope of a declaration applying to all program organization units within a *resource* or *configuration*.

1.3.34 global variable: variable whose *scope* is *global*.

1.3.35 hierarchical addressing: the *direct representation* of a data element as a member of a physical or logical hierarchy, for example, a point within a module which is contained in a rack, which in turn is contained in a cubicle, etc.

1.3.36 identifier: combination of letters, numbers, and underline characters, as specified in 2.1.2, which begins with a letter or underline and which names a *language element*.

1.3.37 in-out variable: *variable* that is declared in a VAR_IN_OUT...END_VAR block.

1.3.38 initial value: the value assigned to a variable at system start-up.

1.3.39 input variable (input): variable which is used to supply an argument to a *program organization unit*.

<http://www.china-gauges.com/>

1.3.40 instance: individual, named copy of the data structure associated with a *function block type* or *program type*, which persists from one *invocation* of the associated operations to the next.

1.3.41 instance name: *identifier* associated with a specific *instance*.

1.3.42 instantiation: the creation of an *instance*.

1.3.43 integer literal: *literal* which directly represents a value of type SINT, INT, LINT, BOOL, BYTE, WORD, DWORD, or LWORD, as defined in 2.3.1.

1.3.44 invocation: the process of initiating the execution of the operations specified in a *program organization unit*.

1.3.45 keyword: lexical unit that characterizes a *language element*, for example, "IF".

1.3.46 label: language construction naming an instruction, network, or group of networks, and including an *identifier*.

1.3.47 language element: any item identified by a symbol on the left-hand side of a production rule in the formal specification given in annex B of this standard.

1.3.48 literal: lexical unit that directly represents a value. (ISO)

1.3.49 local scope: the *scope* of a *declaration* or *label* applying only to the *program organization unit* in which the declaration or label appears.

1.3.50 logical location: the location of a *hierarchically addressed* variable in a schema which may or may not bear any relation to the physical structure of the programmable controller's inputs, outputs, and memory.

1.3.51 long real: real number represented in a *long word*.

1.3.52 long word: 64-bit data element.

1.3.53 memory (user data storage): functional unit to which the user program can store data and from which it can retrieve the stored data.

1.3.54 named element: element of a *structure* which is named by its associated *identifier*.

1.3.55 network: arrangement of nodes and interconnecting branches.

1.3.56 off-delay (on-delay) timer function block: *function block* which delays the *falling (rising) edge* of a Boolean *input* by a specified duration.

1.3.57 operand: *language element* on which an operation is performed.

1.3.58 operator: symbol that represents the action to be performed in an operation.

1.3.59 output variable (output): *variable* which is used to return the result(s) of the *evaluation* of a *program organization unit*.

1.3.60 overloaded: with respect to an operation or *function*, capable of operating on data of different types, as specified in 2.5.1.4.

1.3.61 power flow: the symbolic flow of electrical power in a ladder diagram, used to denote the progression of a logic solving algorithm.

<http://www.china-gauges.com/>

1.3.62 pragma: language construct for the inclusion of text in a program organization unit which may affect the preparation of the program for execution.

1.3.63 program (verb): to design, write, and test user programs.

1.3.64 program organization unit: *function*, *function block*, or program.

NOTE This term may refer to either a type or an instance.

1.3.65 real literal: *literal* representing data of type REAL or LREAL.

1.3.66 resource: *language element* corresponding to a “signal processing function” and its “man-machine interface” and “sensor and actuator interface functions”, if any, as defined in IEC 61131-1.

1.3.67 retentive data: data stored in such a way that its value remains unchanged after a power down / power up sequence.

1.3.68 return: language construction within a *program organization unit* designating an end to the execution sequences in the unit.

1.3.69 rising edge: the change from 0 to 1 of a Boolean variable.

1.3.70 scope: that portion of a *language element* within which a *declaration* or *label* applies.

1.3.71 semantics: the relationships between the symbolic elements of a programming language and their meanings, interpretation and use.

1.3.72 semigraphic representation: representation of graphic information by the use of a limited set of characters.

1.3.73 single data element: data element consisting of a single value.

1.3.74 single-element variable: *variable* which represents a *single data element*.

1.3.75 step: situation in which the behavior of a *program organization unit* with respect to its *inputs* and *outputs* follows a set of rules defined by the associated *actions* of the step.

1.3.76 structured data type: *aggregate* data type which has been declared using a STRUCT or FUNCTION_BLOCK declaration.

1.3.77 subscripting: mechanism for referencing an *array* element by means of an array reference and one or more expressions that, when evaluated, denote the position of the element.

1.3.78 symbolic representation: the use of *identifiers* to name variables.

1.3.79 task: *execution control element* providing for periodic or triggered execution of a group of associated *program organization units*.

1.3.80 time literal: *literal* representing data of type TIME, DATE, TIME_OF_DAY, or DATE_AND_TIME.

1.3.81 transition: the condition whereby control passes from one or more predecessor *steps* to one or more successor steps along a directed link.

1.3.82 unsigned integer: *integer literal* not containing a leading plus (+) or minus (-) sign.

1.3.83 wired OR: construction for achieving the Boolean OR function in the LD language by connecting together the right ends of horizontal connectives with vertical connectives.

<http://www.china-gauges.com/>

1.4 Overview and general requirements

This part of IEC 61131 specifies the syntax and semantics of a unified suite of programming languages for programmable controllers (PCs). These consist of two textual languages, IL (Instruction List) and ST (Structured Text), and two graphical languages, LD (Ladder Diagram) and FBD (Function Block Diagram).

Sequential Function Chart (SFC) elements are defined for structuring the internal organization of programmable controller *programs* and *function blocks*. Also, *configuration elements* are defined which support the installation of programmable controller *programs* into programmable controller systems.

In addition, features are defined which facilitate communication among programmable controllers and other components of automated systems.

The programming language elements defined in this part may be used in an interactive programming environment. The specification of such environments is beyond the scope of this standard; however, such an environment shall be capable of producing textual or graphic program documentation in the formats specified in this standard.

The material in this part is arranged in “bottom-up” fashion, that is, simpler language elements are presented first, in order to minimize forward references in the text. The remainder of this subclause provides an overview of the material presented in this part and incorporates some general requirements.

1.4.1 Software model

The basic high-level language elements and their interrelationships are illustrated in figure 1. These consist of elements which are *programmed* using the languages defined in this standard, that is, *programs* and *function blocks*; and *configuration elements*, namely, *configurations*, *resources*, *tasks*, *global variables*, *access paths*, and instance-specific initializations, which support the installation of programmable controller *programs* into programmable controller systems.

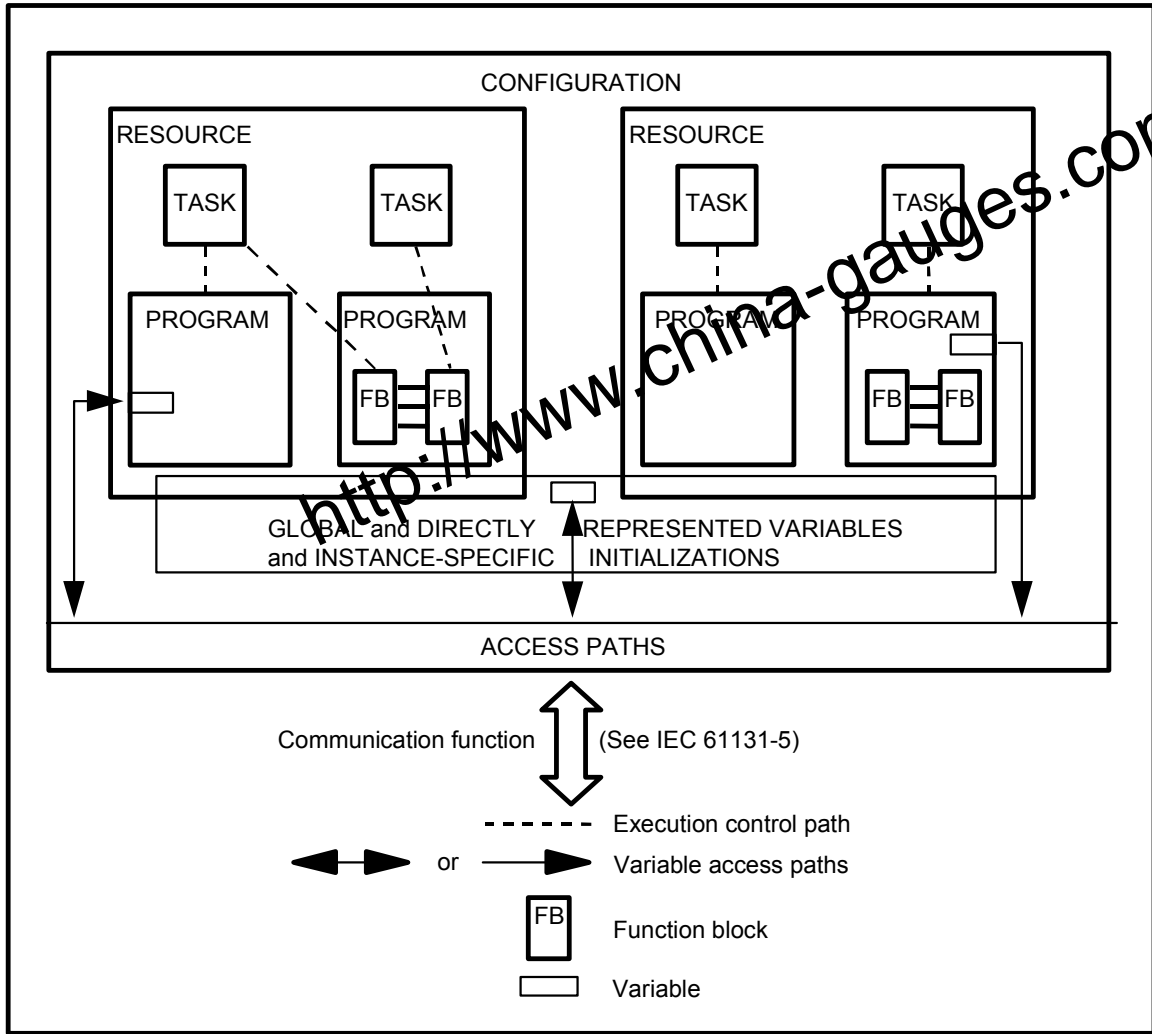

NOTE 1 This figure is illustrative only. The graphical representation is not normative.

NOTE 2 In a configuration with a single resource, the resource need not be explicitly represented.

Figure 1 - Software model

A *configuration* is the language element which corresponds to a *programmable controller system* as defined in IEC 61131-1. A *resource* corresponds to a “signal processing function” and its “man-machine interface” and “sensor and actuator interface” functions (if any) as defined in IEC 61131-1. A *configuration* contains one or more *resources*, each of which contains one or more *programs* executed under the control of zero or more *tasks*. A *program* may contain zero or more *function blocks* or other language elements as defined in this part.

Configurations and *resources* can be started and stopped via the “operator interface”, “programming, testing, and monitoring”, or “operating system” functions defined in IEC 61131-1. The starting of a *configuration* shall cause the initialization of its *global variables* according to the rules given in 2.4.2, followed by the starting of all the *resources* in the configuration. The starting of a *resource* shall cause the initialization of all the *variables* in the resource, followed by the enabling of all the *tasks* in the resource. The stopping of a *resource* shall cause the disabling of all its *tasks*, while the stopping of a *configuration* shall cause the stopping of all its *resources*. Mechanisms for the control of *tasks* are defined in 2.7.2, while mechanisms for the starting and stopping of *configurations* and *resources* via communication functions are defined in IEC 61131-5.

IEC 2468/02

Programs, resources, global variables, access paths (and their corresponding access privileges), and *configurations* can be loaded or deleted by the “communication function” defined in IEC 61131-1. The loading or deletion of a *configuration* or *resource* shall be equivalent to the loading or deletion of all the elements it contains.

Access paths and their corresponding access privileges are defined in 2.7.1.

The mapping of the language elements defined in this subclause on to communication objects is defined in IEC 61131-5.

1.4.2 Communication model

Figure 2 illustrates the ways that values of variables can be communicated among software elements.

As shown in figure 2 a), variable values within a program can be communicated directly by connection of the output of one program element to the input of another. This connection is shown explicitly in graphical languages and implicitly in textual languages.

Variable values can be communicated between programs in the same configuration via *global variables* such as the variable *x* illustrated in figure 2 b). These variables shall be declared as `GLOBAL` in the configuration, and as `EXTERNAL` in the programs, as specified in 2.4.3.

As illustrated in figure 2 c), the values of variables can be communicated between different parts of a program, between programs in the same or different configurations, or between a programmable controller program and a non-programmable controller system, using the communication function blocks defined in IEC 61131-5 and described in 2.5.2.3.5. In addition, programmable controllers or non-programmable controller systems can transfer data which is made available by *access paths*, as illustrated in figure 2 d), using the mechanisms defined in IEC 61131-5.

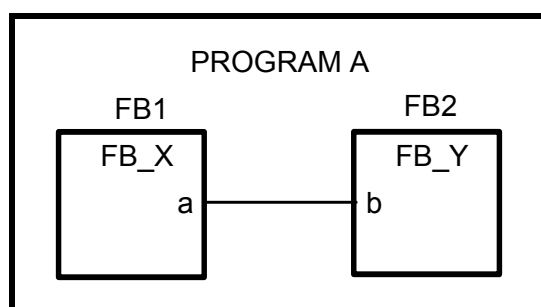

IEC 2469/02

Figure 2 a) - Data flow connection within a program

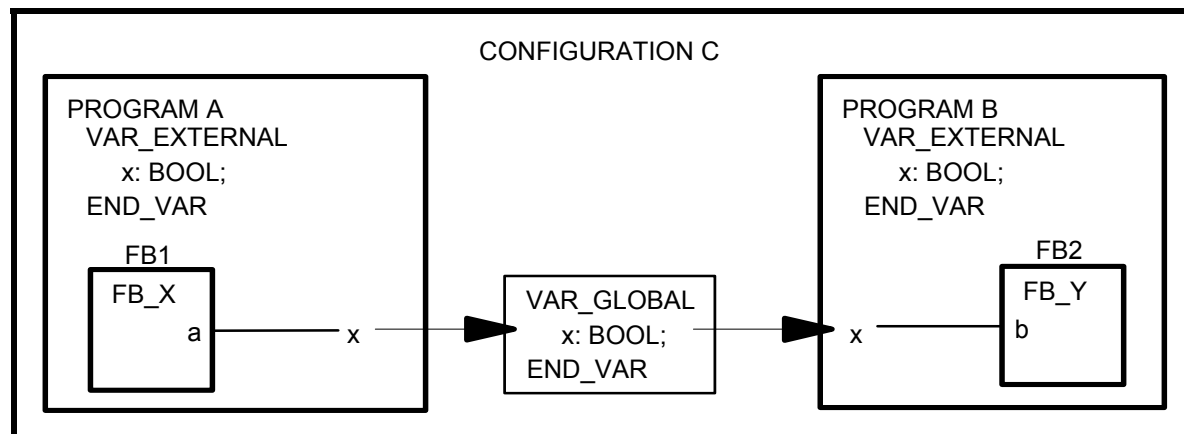

IEC 2470/02

Figure 2 b) - Communication via GLOBAL variables

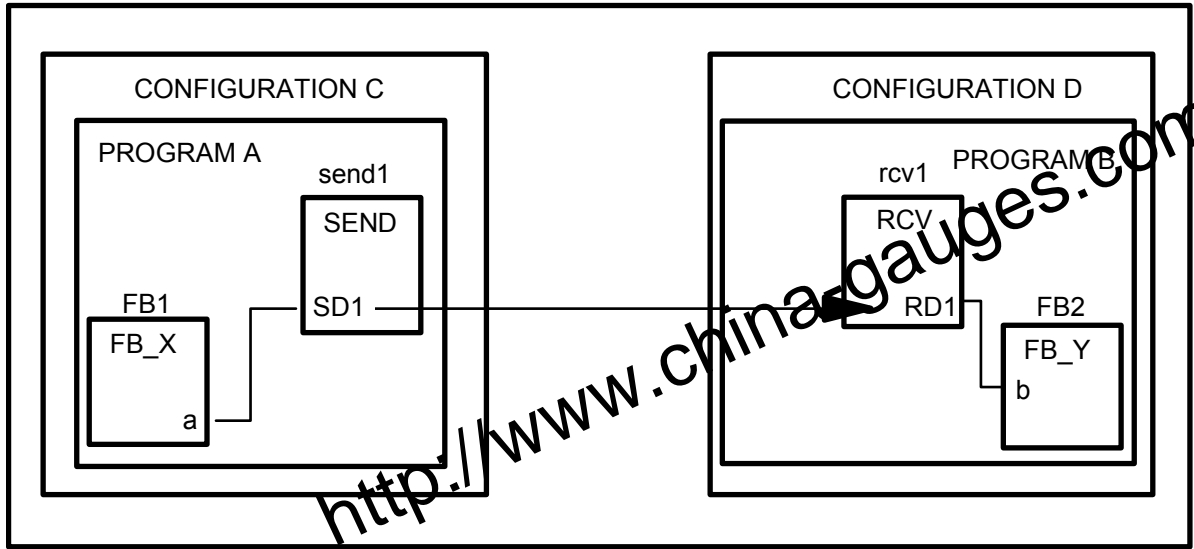

IEC 2471/02

Figure 2 c) - Communication function blocks

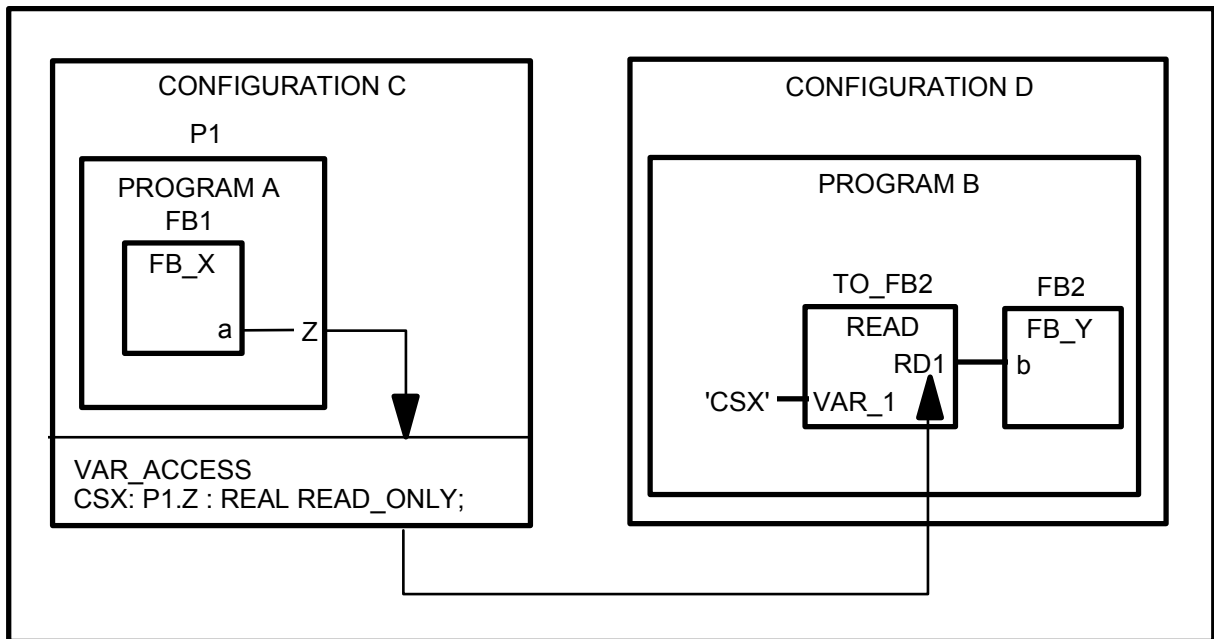

IEC 2472/02

Figure 2 d) - Communication via access paths

- NOTE 1 This figure is illustrative only. The graphical representation is not normative.
- NOTE 2 In these examples, configurations C and D are each considered to have a single resource.
- NOTE 3 The details of the communication function blocks are not shown in this figure. See 2.5.2.3.5 and IEC 61131-5.
- NOTE 4 As specified in 2.7, access paths can be declared on directly represented variables, global variables, or input, output, or internal variables of programs or function block instances.
- NOTE 5 IEC 61131-5 specifies the means by which both PC and non-PC systems can use access paths for reading and writing of variables.

1.4.3 Programming model

The elements of programmable controller programming languages, and the subclauses in which they appear in this part, are classified as follows:

Data types (2.3)
 Variables (2.4)
 Program organization units (2.5)
 Functions (2.5.1)
 Function blocks (2.5.2)
 Programs (2.5.3)
 Sequential Function Chart (SFC) elements (2.6)
 Configuration elements (2.7)
 Global variables (2.7.1)
 Resources (2.7.1)
 Access paths (2.7.1)
 Tasks (2.7.2)

As shown in figure 3, the combination of these elements shall obey the following rules:

- 1) Derived *data types* shall be declared as specified in 2.3.3, using the standard data types specified in 2.3.1 and 2.3.2 and any previously derived data types.
- 2) Derived *functions* can be declared as specified in 2.5.1.3, using standard or derived data types, the standard functions defined in 2.5.1.5, and any previously derived functions. This declaration shall use the mechanisms defined for the IL, ST, LD or FBD language.
- 3) Derived *function blocks* can be declared as specified in 2.5.2.2, using standard or derived data types and functions, the standard function blocks defined in 2.5.2.3, and any previously derived function blocks. This declaration shall use the mechanisms defined for the IL, ST, LD, or FBD language, and can include Sequential Function Chart (SFC) elements as defined in 2.6.
- 4) A *program* shall be declared as specified in 2.5.3, using standard or derived data types, functions, and function blocks. This declaration shall use the mechanisms defined for the IL, ST, LD, or FBD language, and can include Sequential Function Chart (SFC) elements as defined in 2.6.
- 5) *Programs* can be combined into *configurations* using the elements defined in 2.7, that is, *global variables*, *resources*, *tasks*, and *access paths*.

Reference to “previously derived” data types, functions, and function blocks in the above rules is intended to imply that once such a derived element has been declared, its definition is available, for example, in a “library” of derived elements, for use in further derivations. Therefore, the declaration of a derived element type shall not be contained within the declaration of another derived element type.

A programming language other than one of those defined in this standard may be used in the declaration of a *function* or *function block*. The means by which a user program written in one of the languages defined in this standard invokes the execution of, and accesses the data associated with, such a derived function or function block shall be as defined in this standard.

<http://www.china-gauges.com/>

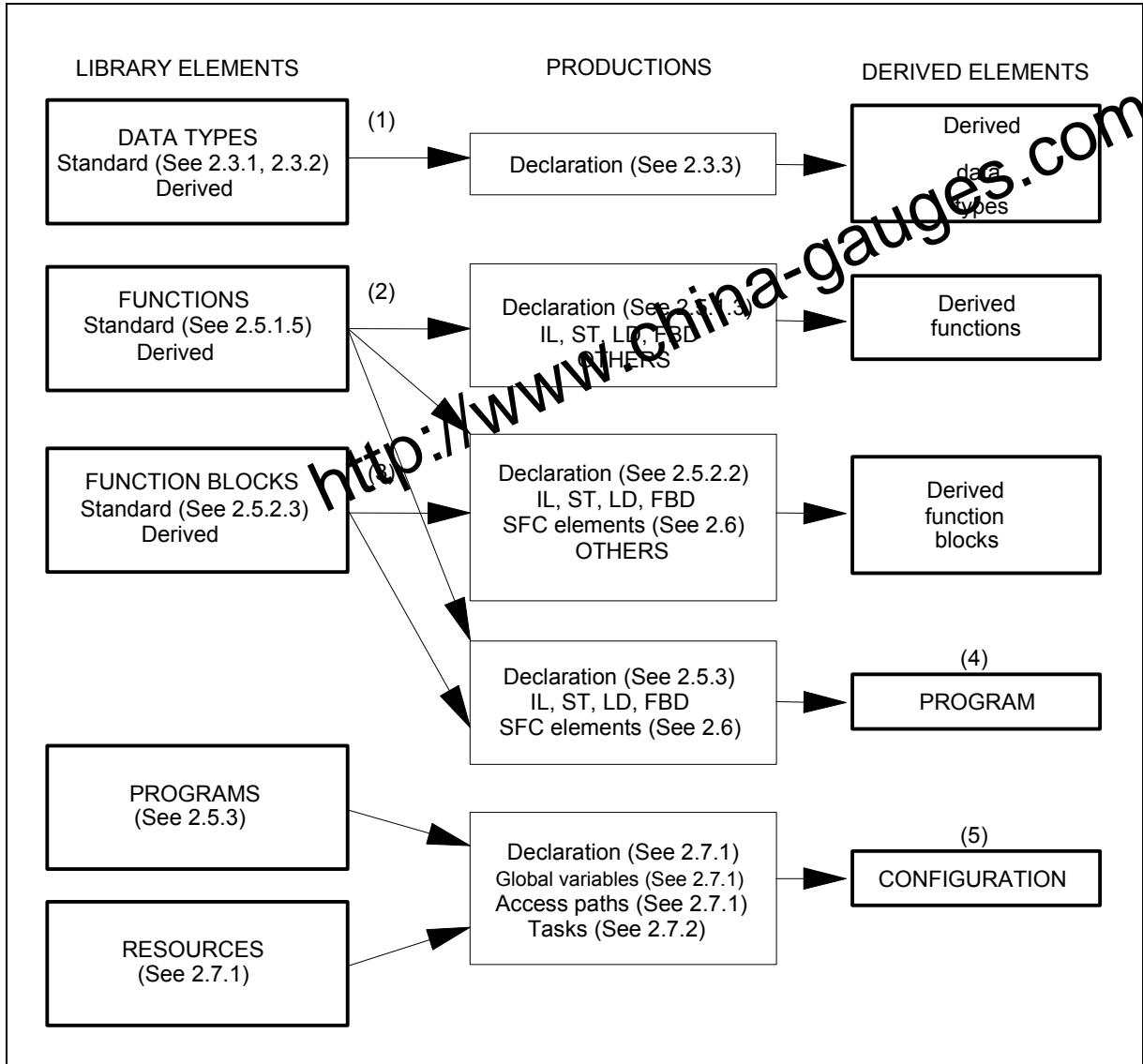

IEC 2473/02

NOTE 1 The parenthesized numbers (1) to (5) refer to the corresponding paragraphs in 1.4.3.

NOTE 2 Data types are used in all productions. For clarity, the corresponding linkages are omitted in this figure.

Figure 3 - Combination of programmable controller language elements

LD - Ladder Diagram (4.2)

FBD - Function Block Diagram (4.3)

IL - Instruction List (3.2)

ST - Structured Text (3.3)

OTHERS - Other programming languages (1.4.3)

1.5 Compliance

This subclause defines the requirements which shall be met by programmable controller systems and programs which claim compliance with this part of IEC 61131.

1.5.1 System compliance

A programmable controller system, as defined in IEC 61131-1, which claims to comply, wholly or partially, with the requirements of this part of IEC 61131 shall do so only as described below.

A compliance statement shall be included in the documentation accompanying the system, or shall be produced by the system itself. The form of the compliance statement shall be:

“This system complies with the requirements of IEC 61131-3, for the following language features:”,

followed by a set of compliance tables in the following format:

Table title

Table No.	Feature No.	Features description
...

Table and feature numbers and descriptions are to be taken from the tables given in the relevant subclauses of this part of IEC 61131. Table titles are to be taken from the following table.

Table title	For features in:
Common elements	Clause 2
Common textual elements	Subclause 3.1
IL language elements	Subclauses 3.2.1 to 3.2.3
ST language elements	Subclauses 3.3.1 to 3.3.2.4
Common graphical elements	Subclause 4.1
LD language elements	Subclause 4.2
FBD language elements	Subclause 4.3

For the purposes of determining compliance, tables 9, 11, 13, 16a, 16b, 32, 38, 47, 48 and 51 shall not be considered tables of features.

A programmable controller system complying with the requirements of this standard with respect to a language defined in this standard:

- a) shall not require the inclusion of substitute or additional language elements in order to accomplish any of the features specified in this standard, unless such elements are identified and treated as noted in rules e) and f) below;
- b) shall be accompanied by a document that specifies the values of all **implementation-dependent parameters** as listed in annex D;
- c) shall be able to determine whether or not a user's language element violates any requirement of this standard, where such a violation is not designated as an **error** in annex E, and report the result of this determination to the user. In the case where the system does not examine the whole program organization unit, the user shall be notified that the determination is incomplete whenever no violations have been detected in the portion of the program organization unit examined;

<http://www.china-gauges.com/>

- d) shall treat each user violation that is designated as an **error** in annex E in at least one of the following ways:
- 1) there shall be a statement in an accompanying document that the error is reported;
 - 2) the system shall report during preparation of the program for execution that an occurrence of that error is possible;
 - 3) the system shall report the error during preparation of the program for execution;
 - 4) the system shall report the error during execution of the program and initiate appropriate system- or user-defined error handling procedures;

and if any violations that are designated as errors are treated in the manner described in d)1) above, then a note referencing each such treatment shall appear in a separate section of the accompanying document;

- e) shall be accompanied by a document that separately describes any features accepted by the system that are prohibited or not specified in this standard. Such features shall be described as being "extensions to the <language> language as defined in IEC 61131-3";
- f) shall be able to process in a manner similar to that specified for errors any use of any such extension;
- g) shall be able to process in a manner similar to that specified for errors any use of one of the **implementation-dependent features** specified in annex D;
- h) shall not use any of the standard data type, function or function block names defined in this standard for manufacturer-defined features whose functionality differs from that described in this standard, unless such features are identified and treated as noted in rules e) and f) above;
- i) shall be accompanied by a document defining, in the form specified in annex A, the formal syntax of all textual language elements supported by the system;
- j) shall be capable of reading and writing files containing any of the language elements defined as alternatives in the production `library_element_declaration` in B.0, in the syntax defined in requirement i) above, encoded according to the "ISO-646 IRV" given as table 1 - Row 00 of ISO/IEC 10646-1.

The phrase "be able to" is used in this subclause to permit the implementation of a software switch with which the user may control the reporting of errors.

In cases where compilation or program entry is aborted due to some limitation of tables, etc., an incomplete determination of the kind "no violations were detected, but the examination is incomplete" will satisfy the requirements of this subclause.

1.5.2 Program compliance

A programmable controller program complying with the requirements of IEC 61131-3:

- a) shall use only those features specified in this standard for the particular language used;
- b) shall not use any features identified as extensions to the language;
- c) shall not rely on any particular interpretation of **implementation-dependent features**.

The results produced by a complying program shall be the same when processed by any complying system which supports the features used by the program, such results are influenced by program execution timing, the use of **implementation-dependent features** (as listed in annex D) in the program, and the execution of error handling procedures.

2 Common elements

This clause defines textual and graphic elements which are common to all the programmable controller programming languages specified in this Part of IEC 61131.

2.1 Use of printed characters

2.1.1 Character set

Textual languages and textual elements of graphic languages shall be represented in terms of the "ISO-646 IRV" given as table 1 - Row 00 of ISO/IEC 10646-1.

The use of characters from additional character sets, for example, the "Latin-1 Supplement" given as table 2 - Row 00 of ISO/IEC 10646-1, is a typical extension of this standard. The encoding of such characters shall be consistent with ISO/IEC 10646-1.

The **required character set** consists of all the characters in columns 002 through 007 of the "ISO-646 IRV" as defined above, except for lower-case letters.

Table 1 - Character set features

No.	Description
2	Lower case characters ^a
3a 3b	Number sign (#) OR Pound sign (£)
4a 4b	Dollar sign (\$) OR Currency sign (¤)
5a 5b	Vertical bar () OR Exclamation mark (!)
NOTE The feature numbering in this table is such as to maintain consistency with the first edition of IEC 61131-3.	
^a When lower-case letters (feature 2) are supported, the case of letters shall not be significant in language elements except within comments as defined in 2.1.5, string literals as defined in 2.2.2, and variables of type <code>STRING</code> and <code>WSTRING</code> as defined in 2.3.1.	

<http://www.china-gauges.com/>

2.1.2 Identifiers

An *identifier* is a string of letters, digits, and underline characters which shall begin with a letter or underline character.

The case of letters shall not be significant in identifiers, for example, the identifiers `abcd`, `ABCD`, and `aBCd` shall be interpreted identically.

Underlines shall be significant in identifiers, for example, `A_BCD` and `AB_CD` shall be interpreted as different identifiers. Multiple leading or multiple embedded underlines are not allowed; for example, the character sequences `__LIM_SW5` and `LIM__SW5` are not valid identifiers. Trailing underlines are not allowed; for example, the character sequence `LIM_SW_` is not a valid identifier.

At least six characters of uniqueness shall be supported in all systems which support the use of identifiers, for example, `ABCDE1` shall be interpreted as different from `ABCDE2` in all such systems. The maximum number of characters allowed in an identifier is an **implementation-dependent** parameter.

Identifier features and examples are shown in table 2.

Table 2 - Identifier features

No.	Feature description	Examples
1	Upper case and numbers	IW215 IW215Z QX75 IDENT
2	Upper and lower case, numbers, embedded underlines	All the above plus: LIM_SW_5 LimSw5 abcd ab_Cd
3	Upper and lower case, numbers, leading or embedded underlines	All the above plus: _MAIN _12V7

2.1.3 Keywords

Keywords are unique combinations of characters utilized as individual syntactic elements as defined in annex B. All keywords used in this standard are listed in annex C. Keywords shall not contain imbedded spaces. The case of characters shall not be significant in keywords; for instance, the keywords "FOR" and "for" are syntactically equivalent. The keywords listed in annex C shall not be used for any other purpose, for example, variable names or extensions as defined in 1.5.1.

NOTE National standards organizations can publish tables of translations of the keywords given in annex C.

2.1.4 Use of white space

The user shall be allowed to insert one or more characters of "white space" anywhere in the text of programmable controller programs except within keywords, literals, enumerated values, identifiers, directly represented variables as described in subclause 2.4.1.1, or delimiter combinations (for example, for comments as defined in 2.1.5). "White space" is defined as the SPACE character with encoded value 32 decimal, as well as non-printing characters such as tab, newline, etc. for which no encoding is given in IEC/ISO 10646-1.

2.1.5 Comments

User comments shall be delimited at the beginning and end by the special character combinations “(” and “)”, respectively, as shown in table 3. Comments shall be permitted anywhere in the program where spaces are allowed, except within character string literals as defined in 2.2.2. Comments shall have no syntactic or semantic significance in any of the languages defined in this standard.

The use of nested comments, for example, (* (* NESTED *) *) shall be treated as an **error** according to the provisions of 1.5.1 d).

The maximum number of characters allowed in a comment is an **implementation-dependent** parameter.

Table 3 - Comment feature

No.	Feature description	Example
1	Comments	<pre>(***** (* A framed comment *) *****)</pre>
NOTE The example given above represents three separate comments.		

2.1.6 Pragmas

As illustrated in table 3 a), pragmas shall be delimited at the beginning and end by curly brackets “{” and “}”, respectively. The syntax and semantics of particular pragma constructions are implementation dependent. Pragmas shall be permitted anywhere in the program where spaces are allowed, except within character string literals as defined in 2.2.2.

NOTE Curly brackets inside a *comment* have no semantic meaning; comments inside curly brackets may or may not have semantic meaning depending on the implementation.

Table 3 a) - Pragma feature

No.	Feature description	Examples
1	Pragmas	<pre>{VERSION 3.1} {AUTHOR JHC} {x := 256, y := 384}</pre>

2.2 External representation of data

External representations of data in the various programmable controller programming languages shall consist of numeric literals, character strings, and time literals.

2.2.1 Numeric literals

There are two classes of numeric literals: integer literals and real literals. A numeric literal is defined as a decimal number or a based number. The maximum number of digits for each kind of numeric literal shall be sufficient to express the entire range and precision of values of all the data types which are represented by the literal in a given implementation.

Single underline characters () inserted between the digits of a numeric literal shall not be significant. No other use of underline characters in numeric literals is allowed.

<http://www.china-gauges.com/>

Decimal literals shall be represented in conventional decimal notation. Real literals shall be distinguished by the presence of a decimal point. An exponent indicates the integer power of ten by which the preceding number is to be multiplied to obtain the value represented. Decimal literals and their exponents can contain a preceding sign (+ or -).

Integer literals can also be represented in base 2, 8, or 16. The base shall be in decimal notation. For base 16, an extended set of digits consisting of the letters A through F shall be used, with the conventional significance of decimal 10 through 15, respectively. Base 16 numbers shall not contain a leading sign (+ or -).

Boolean data shall be represented by integer literals with the value zero (0) or one (1), or the keywords FALSE or TRUE, respectively.

Numeric literal features and examples are shown in table 4.

The *data type* of a boolean or numeric literal can be specified by adding a type prefix to the literal, consisting of the name of an elementary data type and the '#' sign. For examples see feature 9 in table 4.

Table 4 - Numeric literals

No.	Feature description	Examples
1	Integer literals	-12 0 123_456 +986
2	Real literals	-12.0 0.0 0.4560 3.14159_26
3	Real literals with exponents	-1.34E-12 or -1.34e-12 1.0E+6 or 1.0e+6 1.234E6 or 1.234e6
4	Base 2 literals	2#1111_1111 (255 decimal) 2#1110_0000 (224 decimal)
5	Base 8 literals	8#377 (255 decimal) 8#340 (224 decimal)
6	Base 16 literals	16#FF or 16#ff (255 decimal) 16#E0 or 16#e0 (224 decimal)
7	Boolean zero and one	0 1
8	Boolean FALSE and TRUE	FALSE TRUE
9	Typed literals	DINT#5 (DINT representation of 5) UINT#16#9AF (UINT representation of the hexadecimal value 9AF) BOOL#0 BOOL#1 BOOL#TRUE BOOL#FALSE
NOTE The keywords FALSE and TRUE correspond to Boolean values of 0 and 1, respectively.		

2.2.2 Character string literals

Character string literals include single-byte or double-byte encoded characters.

A single-byte character string literal is a sequence of zero or more characters from Row 00 of the ISO/IEC 10646-1 character set prefixed and terminated by the single quote character ('). In single-byte character strings, the three-character combination of the dollar sign (\$) followed by two hexadecimal digits shall be interpreted as the hexadecimal representation of the eight-bit character code, as shown in feature 1 of table 5.

A double-byte character string literal is a sequence of zero or more characters from the ISO/IEC 10646-1 character set prefixed and terminated by the double quote character ("). In double-byte character strings, the five-character combination of the dollar sign (\$) followed by four hexadecimal digits shall be interpreted as the hexadecimal representation of the sixteen-bit character code, as shown in feature 2 of table 5.

Two-character combinations beginning with the dollar sign shall be interpreted as shown in table 6 when they occur in character strings.

Table 5 - Character string literal features

No.	Example	Explanation
1	Single-byte character strings	
	' '	Empty string (length zero)
	'A'	String of length one containing the single character A
	' '	String of length one containing the "space" character
	'\$''	String of length one containing the "single quote" character
	'"'	String of length one containing the "double quote" character
	'\$R\$L'	String of length two containing CR and LF characters
	'\$0A'	String of length one containing the LF character
	'\$\$1.00'	String of length five which would print as "\$1.00"
	'ÄË'	Equivalent strings of length two
	'\$C4\$CB'	
2	Double-byte character strings	
	""	Empty string (length zero)
	"A"	String of length one containing the single character A
	" "	String of length one containing the "space" character
	"'"	String of length one containing the "single quote" character
	"\$""	String of length one containing the "double quote" character
	"\$R\$L"	String of length two containing CR and LF characters
	"\$\$1.00"	String of length five which would print as "\$1.00"
	"ÄË"	Equivalent strings of length two
	"\$00C4\$00CB"	
3	Single-byte typed string literals	
	STRING# 'OK'	String of length two containing two single-byte characters
4	Double-byte typed string literals	
	WSTRING# 'OK'	String of length two containing two double-byte characters
NOTE If a particular implementation supports feature #4 but not feature #2, the implementor may specify implementation-dependent syntax and semantics for the use of the double-quote character.		

Table 6 - Two-character combinations in character strings

No.	Combination	Interpretation when printed
2	\$\$	Dollar sign
3	\$'	Single quote
4	\$L or \$l	Line feed
5	\$N or \$n	Newline
6	\$P or \$p	Form feed (page)
7	\$R or \$r	Carriage return
8	\$T or \$t	Tab
9	\$"	Double quote
<p>NOTE 1 The "newline" character provides an implementation-independent means of defining the end of a line of data for both physical and file I/O; for printing, the effect is that of ending a line of data and resuming printing at the beginning of the next line.</p> <p>NOTE 2 The \$' combination is only valid inside single quoted string literals.</p> <p>NOTE 3 The \$" combination is only valid inside double quoted string literals.</p>		

2.2.3 Time literals

The need to provide external representations for two distinct types of time-related data is recognized: *duration* data for measuring or controlling the elapsed time of a control event, and *time of day* data (which may also include date information) for synchronizing the beginning or end of a control event to an absolute time reference.

Duration and time of day literals shall be delimited on the left by the keywords defined in 2.2.3.1 and 2.2.3.2.

2.2.3.1 Duration

Duration data shall be delimited on the left by the keyword `T#` or `TIME#`. The representation of duration data in terms of days, hours, minutes, seconds, and milliseconds, or any combination thereof, shall be supported as shown in table 7. The least significant time unit can be written in real notation without an exponent.

The units of duration literals can be separated by underline characters.

"Overflow" of the most significant unit of a duration literal is permitted, for example, the notation `T#25h_15m` is permitted.

Time units, for example, seconds, milliseconds, etc., can be represented in upper- or lower- case letters.

As illustrated in table 7, both positive and negative values are allowed for durations.

Table 7 - Duration literal features

No.	Feature description	Examples
1a	Duration literals without underlines: short prefix	T#14ms T#-14ms T#14.7s T#14.7m T#14.7h t#14.7d t#25h15m t#5d14h12m18s3.5ms
1b	long prefix	TIME#14ms TIME#-14ms TIME#14.7s
2a	Duration literals with underlines: short prefix	<u>t#25h_15m_18s_3.5ms</u> <u>t#5d_14h_12m_18s_3.5ms</u>
2b	long prefix	<u>TIME#25h_15m_18s_3.5ms</u> <u>TIME#5d_14h_12m_18s_3.5ms</u>

2.2.3.2 Time of day and date

Prefix keywords for time of day and date literals shall be as shown in table 8. As illustrated in table 9, representation of time-of-day and date information shall be as specified by the syntax given in B.1.2.3.2.

Table 8 - Date and time of day literals

No.	Feature description	Prefix Keyword
1	Date literals (long prefix)	DATE#
2	Date literals (short prefix)	D#
3	Time of day literals (long prefix)	TIME_OF_DAY#
4	Time of day literals (short prefix)	TOD#
5	Date and time literals (long prefix)	DATE_AND_TIME#
6	Date and time literals (short prefix)	DT#

Table 9 - Examples of date and time of day literals

Long prefix notation	Short prefix notation
DATE#1984-06-25 date#1984-06-25	D#1984-06-25 d#1984-06-25
TIME_OF_DAY#15:36:55.36 time_of_day#15:36:55.36	TOD#15:36:55.36 tod#15:36:55.36
DATE_AND_TIME#1984-06-25-15:36:55.36 date_and_time#1984-06-25-15:36:55.36	DT#1984-06-25-15:36:55.36 dt#1984-06-25-15:36:55.36

2.3 Data types

A number of elementary (pre-defined) data types are recognized by this standard. Additionally, generic data types are defined for use in the definition of overloaded functions (see 2.5.1.4). A mechanism for the user or manufacturer to specify additional data types is also defined.

2.3.1 Elementary data types

The elementary data types, keyword for each data type, number of bits per data element, and range of values for each elementary data type shall be as shown in table 10.

Table 10 - Elementary data types

No.	Keyword	Data type	N ^a
1	BOOL	Boolean	1 ^h
2	SINT	Short integer	8 ^c
3	INT	Integer	16 ^c
4	DINT	Double integer	32 ^c
5	LINT	Long integer	64 ^c
6	USINT	Unsigned short integer	8 ^d
7	UINT	Unsigned integer	16 ^d
8	UDINT	Unsigned double integer	32 ^d
9	ULINT	Unsigned long integer	64 ^d
10	REAL	Real numbers	32 ^e
11	LREAL	Long reals	64 ^f
12	TIME	Duration	-- ^b
13	DATE	Date (only)	-- ^b
14	TIME_OF_DAY or TOD	Time of day (only)	-- ^b
15	DATE_AND_TIME or DT	Date and time of Day	-- ^b
16	STRING	Variable-length single-byte character string	8 ^{i,g}
17	BYTE	Bit string of length 8	8 ^{i,g}
18	WORD	Bit string of length 16	16 ^{i,g}
19	DWORD	Bit string of length 32	32 ^{i,g}
20	LWORD	Bit string of length 64	64 ^{i,g}
21	WSTRING	Variable-length double-byte character string	16 ^{i,g}

<http://www.china-gauges.com/>

Table 10 - Elementary data types

<p>^a Entries in this column shall be interpreted as specified in the footnotes.</p> <p>^b The range of values and precision of representation in these data types is implementation dependent.</p> <p>^c The range of values for variables of this data type is from $-(2^{N-1})$ to (2^{N-1}).</p> <p>^d The range of values for variables of this data type is from 0 to $(2^N)-1$.</p> <p>^e The range of values for variables of this data type shall be as defined in IEC 60559 for the basic single width floating-point format.</p> <p>^f The range of values for variables of this data type shall be as defined in IEC 60559 for the basic double width floating-point format.</p> <p>^g A numeric range of values does not apply to this data type.</p> <p>^h The possible values of variables of this data type shall be 0 and 1, corresponding to the keywords <code>FALSE</code> and <code>TRUE</code>, respectively.</p> <p>ⁱ The value of <code>N</code> indicates the number of bits/character for this data type.</p> <p>^j The value of <code>N</code> indicates the number of bits in the bit string for this data type.</p>

2.3.2 Generic data types

In addition to the data types shown in table 10, the hierarchy of generic data types shown in table 11 can be used in the specification of inputs and outputs of standard functions and function blocks (see subclause 2.5.1.4). Generic data types are identified by the prefix "ANY". The use of generic data types is subject to the following rules:

- 1) Generic data types shall not be used in user-declared program organization units as defined in 2.5.
- 2) The generic type of a *subrange* derived type (feature 3 of table 12) shall be `ANY_INT`.
- 3) The generic type of a *directly derived* type (feature 1 of table 12) shall be the same as the generic type of the elementary type from which it is derived.
- 4) The generic type of all other derived types defined in table 12 shall be `ANY_DERIVED`.

Table 11 - Hierarchy of generic data types

ANY
ANY_DERIVED (Derived data types - see preceding text)
ANY_ELEMENTARY
ANY_MAGNITUDE
ANY_NUM
ANY_REAL
LREAL
REAL
ANY_INT
LINT, DINT, INT, SINT
ULINT, UDINT, UINT, USINT
TIME
ANY_BIT
LWORD, DWORD, WORD, BYTE, BOOL
ANY_STRING
STRING
WSTRING
ANY_DATE
DATE_AND_TIME
DATE, TIME_OF_DAY

2.3.3 Derived data types

2.3.3.1 Declaration

Derived (i.e., user- or manufacturer-specified) data types can be declared using the `TYPE...END_TYPE` textual construction shown in table 12. These derived data types can then be used, in addition to the elementary data types defined in 2.3.1, in variable declarations as defined in 2.4.3.

An *enumerated* data type declaration specifies that the value of any data element of that type can only take on one of the values given in the associated list of identifiers, as illustrated in table 12. The enumeration list defines an ordered set of enumerated values, starting with the first identifier of the list, and ending with the last. Different enumerated data types may use the same identifiers for enumerated values. The maximum allowed number of enumerated values is an **implementation-dependent** parameter.

To enable unique identification when used in a particular context, enumerated literals may be qualified by a prefix consisting of their associated data type name and the '#' sign, similar to typed literals defined in 2.2.1. Such a prefix shall not be used inside an enumeration list. It is an **error** if sufficient information is not provided in an enumerated literal to determine its value unambiguously.

A *subrange* declaration specifies that the value of any data element of that type can only take on values between and including the specified upper and lower limits, as illustrated in table 12. It is an **error** if the value of a value of a subrange type falls outside the specified range of values.

A `STRUCT` declaration specifies that data elements of that type shall contain sub-elements of specified types which can be accessed by the specified names. For instance, an element of data type `ANALOG_CHANNEL_CONFIGURATION` as declared in table 12 will contain a `RANGE` sub-element of type `ANALOG_SIGNAL_RANGE`, a `MIN_SCALE` sub-element of type `ANALOG_DATA`, and a `MAX_SCALE` element of type `ANALOG_DATA`. The maximum number of structure elements, the maximum amount of data that can be contained in a structure, and the maximum number of nested levels of structure element addressing are **implementation-dependent** parameters.

<http://www.china-gauges.com/>

An `ARRAY` declaration specifies that a sufficient amount of data storage shall be allocated for each element of that type to store all the data which can be indexed by the specified index subrange(s). Thus, any element of type `ANALOG_16_INPUT_CONFIGURATION` as shown in table 12 contains (among other elements) sufficient storage for 16 `CHANNEL` elements of type `ANALOG_CHANNEL_CONFIGURATION`. Mechanisms for access to array elements are defined in 2.4.1.2. The maximum number of array subscripts, maximum array size and maximum range of subscript values are **implementation-dependent** parameters.

2.3.3.2 Initialization

The default initial value of an *enumerated* data type shall be the first identifier in the associated enumeration list, or a value specified by the assignment operator “:=”. For instance, as shown in table 12, No.2, and table 14, No.2, the default initial values of elements of data types `ANALOG_SIGNAL_TYPE` and `ANALOG_SIGNAL_RANGE` are `SINGLE_ENDED` and `UNIPOLAR_1_5V`, respectively.

For data types with *subranges*, the default initial values shall be the first (lower) limit of the subrange, unless otherwise specified by an assignment operator. For instance, as declared in table 12, the default initial value of elements of type `ANALOG_DATA` is `-4095`, while the default initial value for the `FILTER_PARAMETER` sub-element of elements of type `ANALOG_16_INPUT_CONFIGURATION` is zero. In contrast, the default initial value of elements of type `ANALOG_DATA2` as declared in table 14 is zero.

For other derived data types, the default initial values, unless specified otherwise by the use of the assignment operator “:=” in the `TYPE` declaration, shall be the default initial values of the underlying elementary data types as defined in table 13. Further examples of the use of the assignment operator for initialization are given in 2.4.2.

The default maximum length of elements of type `STRING` and `WSTRING` shall be an **implementation-dependent** value unless specified otherwise by a parenthesized maximum length (which shall not exceed the implementation-dependent default value) in the associated declaration. For example, if type `STR10` is declared by

```
TYPE STR10 : STRING[10] := 'ABCDEF'; END_TYPE
```

the maximum length, default initial value, and default initial length of data elements of type `STR10` are 10 characters, 'ABCDEF', and 6 characters, respectively. The maximum allowed length of `STRING` and `WSTRING` variables is an **implementation-dependent** parameter.

Table 12 - Data type declaration features

No.	Feature/textual example
1	Direct derivation from elementary types, e.g.: TYPE RU_REAL : REAL ; END_TYPE
2	Enumerated data types, e.g.: TYPE ANALOG_SIGNAL_TYPE : (SINGLE_ENDED, DIFFERENTIAL) ; END_TYPE
3	Subrange data types, e.g.: TYPE ANALOG_DATA : INT (-4095..4095) ; END_TYPE
4	Array data types, e.g.: TYPE ANALOG_16_INPUT_DATA : ARRAY [1..16] OF ANALOG_DATA ; END_TYPE

http://www.china-gauges.com/

Table 12 - Data type declaration features

No.	Feature/textual example
5	Structured data types, e.g.: <pre> TYPE ANALOG_CHANNEL_CONFIGURATION : STRUCT RANGE : ANALOG_SIGNAL_RANGE ; MIN_SCALE : ANALOG_DATA ; MAX_SCALE : ANALOG_DATA ; END_STRUCT ; ANALOG_16_INPUT_CONFIGURATION : STRUCT SIGNAL_TYPE : ANALOG_SIGNAL_TYPE ; FILTER_PARAMETER : SINT (0..99) ; CHANNEL : ARRAY [1..16] OF ANALOG_CHANNEL_CONFIGURATION ; END_STRUCT ; END_TYPE </pre>
NOTE For examples of the use of these types in variable declarations, see 2.3.3.3, 2.4.1.2, and table 17.	

Table 13 - Default initial values of elementary data types

Data type(s)	Initial value
BOOL, SINT, INT, DINT, LINT	0
USINT, UINT, UDINT, ULINT	0
BYTE, WORD, DWORD, LWORD	0
REAL, LREAL	0.0
TIME	T#0S
DATE	D#0001-01-01
TIME_OF_DAY	TOD#00:00:00
DATE_AND_TIME	DT#0001-01-01-00:00:00
STRING	' ' (the empty string)
WSTRING	"" (the empty string)

Table 14 - Data type initial value declaration features

No.	Feature/textual example
1	Initialization of directly derived types, e.g.: TYPE FREQ : REAL := 50.0 ; END_TYPE
2	Initialization of enumerated data types, e.g.: TYPE ANALOG_SIGNAL_RANGE : (BIPOLAR_10V, (* -10 to +10 VDC *) UNIPOLAR_10V, (* 0 to +10 VDC *) UNIPOLAR_1_5V, (* +1 to +5 VDC *) UNIPOLAR_0_5V, (* 0 to +5 VDC *) UNIPOLAR_4_20_MA, (* +4 to +20 mADC *) UNIPOLAR_0_20_MA, (* 0 to +20 mADC *)) := UNIPOLAR_1_5V ; END_TYPE
3	Initialization of subrange data types, e.g.: TYPE ANALOG_DATAZ : INT (-4095..4095) := 0 ; END_TYPE
4	Initialization of array data types, e.g.: TYPE ANALOG_16_INPUT_DATAI : ARRAY [1..16] OF ANALOG_DATA := [8(-4095), 8(4095)] ; END_TYPE
5	Initialization of structured data type elements, e.g.: TYPE ANALOG_CHANNEL_CONFIGURATIONI : STRUCT RANGE : ANALOG_SIGNAL_RANGE ; MIN_SCALE : ANALOG_DATA := -4095 ; MAX_SCALE : ANALOG_DATA := 4095 ; END_STRUCT ; END_TYPE
6	Initialization of derived structured data types, e.g.: TYPE ANALOG_CHANNEL_CONFIGZ : ANALOG_CHANNEL_CONFIGURATIONI := (MIN_SCALE := 0, MAX_SCALE := 4000); END_TYPE

2.3.3.3 Usage

The usage of variables which are declared (as defined in 2.4.3.1) to be of derived data types shall conform to the following rules:

- 1) A single-element variable, as defined in 2.4.1.1, of a derived type, can be used anywhere that a variable of its "parent's" type can be used, for example variables of the types RU_REAL and FREQ as shown in tables 12 and 14 can be used anywhere that a variable of type REAL could be used, and variables of type ANALOG_DATA can be used anywhere that a variable of type INT could be used.

This rule can be applied recursively. For example, given the declarations below, the variable R3 of type R2 can be used anywhere a variable of type REAL can be used:

```
TYPE R1 : REAL := 1.0 ; END_TYPE
TYPE R2 : R1 ; END_TYPE
VAR R3: R2; END_VAR
```

- 2) An element of a multi-element variable, as defined in 2.4.1.2, can be used anywhere the “parent” type can be used, for example, given the declaration of `ANALOG_16_INPUT_DATA` in table 12 and the declaration

```
VAR INS : ANALOG_16_INPUT_DATA ; END_VAR
```

the variables `INS[1]` through `INS[16]` can be used anywhere that a variable of type `INT` could be used.

This rule can also be applied recursively, for example, given the declarations of `ANALOG_16_INPUT_CONFIGURATION`, `ANALOG_CHANNEL_CONFIGURATION`, and `ANALOG_DATA` in table 12 and the declaration

```
VAR CONF : ANALOG_16_INPUT_CONFIGURATION ; END_VAR
```

the variable `CONF.CHANNEL[2].MIN_SCALE` can be used anywhere that a variable of type `INT` could be used.

2.4 Variables

In contrast to the external representations of data described in 2.2, *variables* provide a means of identifying data objects whose contents may change, for example, data associated with the inputs, outputs, or memory of the programmable controller. A variable can be declared to be one of the elementary types defined in 2.3.1, or one of the derived types which are declared as defined in 2.3.3.1.

2.4.1 Representation

2.4.1.1 Single-element variables

A *single-element variable* is defined as a variable which represents a single data element of one of the elementary types defined in 2.3.1; a derived enumeration or subrange type as defined in 2.3.3.1; or a derived type whose “parentage”, as defined recursively in 2.3.3.3, is traceable to an elementary, enumeration or subrange type. This subclause defines the means of representing such variables *symbolically*, or alternatively in a manner which *directly* represents the association of the data element with physical or logical locations in the programmable controller's input, output, or memory structure.

Identifiers, as defined in 2.1.2, shall be used for symbolic representation of variables.

Direct representation of a single-element variable shall be provided by a special symbol formed by the concatenation of the percent sign “%” (character code 037 decimal in table 1 - Row 00 of ISO/IEC 10646-1), a *location prefix* and a *size prefix* from table 15, and one or more unsigned integers, separated by periods (.).

In the case that a directly represented variable is used in a location assignment to an internal variable in the declaration part of a *program* or a *function block type* as defined in 2.4.3.1, an asterisk “*” shall be used in place of the size prefix and the one or several unsigned integers in the concatenation to indicate that the direct representation is not yet fully specified. The percent sign and the location prefix `I`, `Q` or `M` from table 15 shall always be present in the direct representation.

In both cases, the use of this feature requires that the location of the variable so declared shall be fully specified inside the `VAR_CONFIG...END_VAR` construction of the configuration as defined in 2.7.1 for every instance of the containing type.

It is an **error** if any of the full specifications in the `VAR_CONFIG...END_VAR` construction is missing for any incomplete address specification expressed by the asterisk notation in any instance of programs or function block types which contain such incomplete specifications.

<http://www.china-gauges.com/>

EXAMPLES

%QX75 and %Q75	Output bit 75
%IW215	Input word location 215
%QB7	Output byte location 7
%MD48	Double word at memory location 48
%IW2.5.7.1	See explanation below
%Q*	Output at a not yet specified location

The manufacturer shall specify the correspondence between the direct representation of a variable and the physical or logical location of the addressed item in memory, input or output. When a direct representation is extended with additional integer fields separated by periods, it shall be interpreted as a *hierarchical* physical or logical address with the leftmost field representing the highest level of the hierarchy, with successive lower levels appearing to the right. For instance, the variable %IW2.5.7.1 may represent the first "channel" (word) of the seventh "module" in the fifth "rack" of the second "I/O bus" of a programmable controller system.

The use of hierarchical addressing to permit a program in one programmable controller system to access data in another programmable controller shall be considered a language extension.

The use of directly represented variables is permitted in *function blocks* as defined in 2.5.2, *programs* as defined in 2.5.3, and in *configurations* and *resources* as defined in 2.7.1. The maximum number of levels of hierarchical addressing is an **implementation-dependent parameter**.

Table 15 - Location and size prefix features for directly represented variables

No.	Prefix	Meaning	Default data type
1	I	Input location	
2	Q	Output location	
3	M	Memory location	
4	X	Single bit size	BOOL
5	None	Single bit size	BOOL
6	B	Byte (8 bits) size	BYTE
7	W	Word (16 bits) size	WORD
8	D	Double word (32 bits) size	DWORD
9	L	Long (quad) word (64 bits) size	LWORD
10	Use of an asterisk (*) to indicate a not yet specified location (NOTE 2)		
NOTE 1 National standards organizations can publish tables of translations of these prefixes.			
NOTE 2 Use of feature 10 in this table requires feature 11 of table 49 and vice versa.			

2.4.1.2 Multi-element variables

The *multi-element variable* types defined in this standard are *arrays* and *structures*.

An *array* is a collection of data elements of the same data type referenced by one or more *subscripts* enclosed in brackets and separated by commas. In the ST language defined in subclause 3.3, a subscript shall be an expression yielding a value corresponding to one of the sub-types of generic type ANY_INT as defined in table 11. The form of subscripts in the L language defined in 3.2, and the graphic languages defined in clause 4, is restricted to *single element variables* or *integer literals*.

An example of the use of array variables in the ST language as defined in 3.3 is:

```
OUTARY[%MB6, SYM] := INARY[1] * INARY[7] - INARY[%MB6] * %IW62 ;
```

A *structured variable* is a variable which is declared to be of a type which has previously been specified to be a *data structure*, i.e., a data type consisting of a collection of named elements.

An element of a structured variable shall be represented by two or more identifiers or array accesses separated by single periods (.). The first identifier represents the name of the structured element, and subsequent identifiers represent the sequence of component names to access the particular data element within the data structure.

For instance, if the variable MODULE_5_CONFIG has been declared to be of type ANALOG_16_INPUT_CONFIGURATION as shown in table 12, the following statements in the ST language defined in 3.3 would cause the value SINGLE_ENDED to be assigned to the element SIGNAL_TYPE of the variable MODULE_5_CONFIG, while the value BIPOLAR_10V would be assigned to the RANGE sub-element of the fifth CHANNEL element of MODULE_5_CONFIG:

```
MODULE_5_CONFIG.SIGNAL_TYPE := SINGLE_ENDED;
MODULE_5_CONFIG.CHANNEL[5].RANGE := BIPOLAR_10V;
```

2.4.2 Initialization

When a configuration element (*resource* or *configuration*) is “started” as defined in 1.4.1, each of the variables associated with the configuration element and its *programs* can take on one of the following initial values:

- the value the variable had when the configuration element was “stopped” (a *retained* value);
- a user-specified initial value;
- the default initial value for the variable's associated data type.

The user can declare that a variable is to be *retentive* by using the RETAIN qualifier specified in table 16 a), when this feature is supported by the implementation.

The initial value of a variable upon starting of its associated configuration element shall be determined according to the following rules:

- 1) If the starting operation is a “warm restart” as defined in IEC 61131-1, the initial values of *retentive* variables shall be their *retained* values as defined above.
- 2) If the operation is a “cold restart” as defined in IEC 61131-1, the initial values of *retentive* variables shall be the user-specified initial values, or the default value, as defined in 2.3.3.2, for the associated data type of any variable for which no initial value is specified by the user.
- 3) Non-retained variables shall be initialized to the user-specified initial values, or to the default value, as defined in 2.3.3.2, for the associated data type of any variable for which no initial value is specified by the user.
- 4) Variables which represent *inputs* of the *programmable controller system* as defined in IEC 61131-1 shall be initialized in an **implementation-dependent** manner.

2.4.3 Declaration

Each declaration of a program organization unit type (i.e., each declaration of a *program*, *function*, or *function block*, as defined in 2.5) shall contain at its beginning at least one *declaration part* which specifies the types (and, if necessary, the physical or logical location) of the variables used in the organization unit. This declaration part shall have the textual form of one of the keywords VAR, VAR_INPUT, or VAR_OUTPUT as defined in table 16 a), followed in the case of VAR by zero or one occurrence of the qualifiers RETAIN, NON_RETAIN or the qualifier CONSTANT, and in the case of VAR_INPUT or VAR_OUTPUT by zero or one occurrence of the qualifier RETAIN or NON_RETAIN, followed by one or more declarations separated by semicolons and terminated by the keyword END_VAR. When a programmable controller supports the declaration by the user of initial values for variables, this declaration shall be accomplished in the declaration part(s) as defined in this subclause.

Table 16 a) - Variable declaration keywords

Keyword	Variable usage
VAR	Internal to organization unit
VAR_INPUT	Externally supplied, not modifiable within organization unit
VAR_OUTPUT	Supplied by organization unit to external entities
VAR_IN_OUT	Supplied by external entities - can be modified within organization unit
VAR_EXTERNAL	Supplied by configuration via VAR_GLOBAL (2.7.1) Can be modified within organization unit
VAR_GLOBAL	Global variable declaration (2.7.1)
VAR_ACCESS	Access path declaration (2.7.1)
VAR_TEMP	Temporary storage for variables in function blocks and programs (2.4.3)
VAR_CONFIG	Instance-specific initialization and location assignment.
RETAIN ^{b, c, d, e}	Retentive variables (see preceding text)
NON_RETAIN ^{b, c, d, e}	Non-retentive variables (see preceding text)
CONSTANT ^a	Constant (variable cannot be modified)
AT	Location assignment (2.4.3.1)
NOTE 1 The usage of these keywords is a feature of the program organization unit or configuration element in which they are used. Normative requirements for the use of these keywords are given in 2.4.3.1, 2.4.3.2, 2.5 and 2.7.	
NOTE 2 Examples of the use of VAR_IN_OUT variables are given in figures 11b and 12.	

Table 16 a) - Variable declaration keywords

<p>^a The <code>CONSTANT</code> qualifier shall not be used in the declaration of <i>function block instances</i> as described in 2.5.2.1.</p> <p>^b The <code>RETAIN</code> and <code>NON_RETAIN</code> qualifiers may be used for <i>variables</i> declared in <code>VAR_GLOBAL</code>, <code>VAR_INPUT</code>, <code>VAR_OUTPUT</code>, and <code>VAR_GLOBAL</code> blocks but not in <code>VAR_IN_OUT</code> blocks and not for individual elements of structures.</p> <p>^c Usage of <code>RETAIN</code> and <code>NON_RETAIN</code> for <i>function block</i> and <i>program instances</i> is allowed. The effect is that all members of the instance are treated as <code>RETAIN</code> or <code>NON_RETAIN</code>, except if:</p> <ul style="list-style-type: none"> - the member is explicitly declared as <code>RETAIN</code> or <code>NON_RETAIN</code> in the function block or program type definition; - the member itself is a <i>function block</i>. <p>^d Usage of <code>RETAIN</code> and <code>NON_RETAIN</code> for <i>instances</i> of structured data types is allowed. The effect is that all structure members, also those of nested structures, are treated as <code>RETAIN</code> or <code>NON_RETAIN</code>.</p> <p>^e Both <code>RETAIN</code> and <code>NON_RETAIN</code> are features. If a variable is neither explicitly declared as <code>RETAIN</code> nor as <code>NON_RETAIN</code> the “warm start” behaviour of the variable is implementation dependent.</p>
--

Within *function blocks* and *programs*, variables can be declared in a `VAR_TEMP...END_VAR` construction. These variables are allocated and initialized at each *invocation* of an *instance* of the program organization unit, and do not persist between invocations.

The *scope* (range of validity) of the declarations contained in the declaration part shall be *local* to the program organization unit in which the declaration part is contained. That is, the declared variables shall not be accessible to other program organization units except by explicit argument passing via variables which have been declared as *inputs* or *outputs* of those units. The one exception to this rule is the case of variables which have been declared to be *global*, as defined in 2.7.1. Such variables are only accessible to a program organization unit via a `VAR_EXTERNAL` declaration. The type of a variable declared in a `VAR_EXTERNAL` block shall agree with the type declared in the `VAR_GLOBAL` block of the associated *program, configuration or resource*.

It shall be an **error** if:

- any program organization unit attempts to modify the value of a variable that has been declared with the `CONSTANT` qualifier;
- a variable declared as `VAR_GLOBAL CONSTANT` in a configuration element or program organization unit (the “containing element”) is used in a `VAR_EXTERNAL` declaration (without the `CONSTANT` qualifier) of any element contained within the containing element as illustrated below.

The maximum number of variables allowed in a variable declaration block is an **implementation-dependent** parameter.

Table 16 b) – Usages of VAR_GLOBAL, VAR_EXTERNAL and CONSTANT declarations

Declaration in containing element	Declaration in contained element	Allowed?
VAR_GLOBAL X ...	VAR_EXTERNAL CONSTANT X...	Yes
VAR_GLOBAL X ...	VAR_EXTERNAL X...	Yes
VAR_GLOBAL CONSTANT X ...	VAR_EXTERNAL CONSTANT	Yes
VAR_GLOBAL CONSTANT X ...	VAR_EXTERNAL X	NO

2.4.3.1 Type assignment

As shown in table 17, the VAR...END_VAR construction shall be used to specify data types and retentivity for directly represented variables. This construction shall also be used to specify data types, retentivity, and (where necessary, in *programs* and VAR_GLOBAL declarations only) the physical or logical location of symbolically represented single- or multi-element variables. The usage of the VAR_INPUT, VAR_OUTPUT, and VAR_IN_OUT constructions is defined in 2.5.

The assignment of a physical or logical address to a symbolically represented variable shall be accomplished by the use of the AT keyword. Where no such assignment is made, automatic allocation of the variable to an appropriate location in the programmable controller memory shall be provided.

The asterisk notation (feature No. 10 in table 15) can be used in address assignments inside programs and function block types to denote not yet fully specified locations for directly represented variables.

Table 17 - Variable type assignment features

No.	Feature/examples	
1 ^a	Declaration of directly represented variables	
	VAR AT %IW6.2 : WORD; AT %MW6 : INT ; END_VAR	16-bit string (note 2) 16-bit integer, initial value = 0
2 ^a	Declaration of directly represented retentive variables	
	VAR RETAIN AT %QW5 : WORD ; END_VAR	At cold restart, will be initialized to a 16-bit string with value 16#0000
3 ^a	Declaration of locations of symbolic variables	
	VAR_GLOBAL LIM_SW_S5 AT %IX27 : BOOL;	Assigns input bit 27 to the Boolean variable LIM_SW_5 (note 2)
	CONV_START AT %QX25 : BOOL;	Assigns output bit 25 to the Boolean variable CONV_START
	TEMPERATURE AT %IW28 : INT;	Assigns input word 28 to the integer variable TEMPERATURE (note 2)
	VAR C2 AT %Q* : BYTE ; END_VAR	Assigns not yet located output byte to bitstring variable C2 of length 8 bits

Table 17 - Variable type assignment features

No.	Feature/examples	
4 ^a	Array location assignment	
	<pre>VAR INARY AT %IW6 : ARRAY [0..9] OF INT; END_VAR</pre>	Declares an array of 10 integers to be allocated to contiguous input locations starting at %IW6 (note 2)
5	Automatic memory allocation of symbolic variables	
	<pre>VAR CONDITION_RED : BOOL; IBOUNCE : WORD; MYDUB : DWORD; AWORD, BWORD, CWORD : INT; MYSTR: STRING[10]; END_VAR</pre>	Allocates a memory bit to the Boolean variable CONDITION_RED. Allocates a memory word to the 16-bit string variable IBOUNCE. Allocates a double memory word to the 32-bit-string variable MYDUB. Allocates 3 separate memory words for the integer variables AWORD, BWORD, and CWORD. Allocates memory to contain a string with a maximum length of 10 characters. After initialization, the string has length 0 and contains the empty string ' '.
6	Array declaration	
	<pre>VAR THREE : ARRAY[1..5,1..10,1..8] OF INT; END_VAR</pre>	Allocates 400 memory words for a three-dimensional array of integers
7	Retentive array declaration	
	<pre>VAR RETAIN RTBT: ARRAY[1..2,1..3] OF INT; END_VAR</pre>	Declares retentive array RTBT with “cold restart” initial values of 0 for all elements
8	Declaration of structured variables	
	<pre>VAR MODULE_8_CONFIG : ANALOG_16_INPUT_CONFIGURATION; END_VAR</pre>	Declaration of a variable of derived data type (see table 12)
<p>NOTE 1 Initialization of system inputs is implementation-dependent; see 2.4.2.</p>		
<p>NOTE 2 The notes to table 16 a) also apply to this table.</p>		
<p>^a If directly represented variables are explicitly located, features 1 to 4 can only be used in PROGRAM and VAR_GLOBAL declarations, as defined in 2.5.3 and 2.7.1, respectively. If the asterisk notation of feature 10 in table 15 is used to indicate instance specific location assignment of a partly specified directly represented variable, features 1 and 2 can not be used, and features 3 and 4 can only be used in declarations of internal variables of function blocks and programs, as defined in 2.5.2 and 2.5.3, respectively.</p>		

2.4.3.2 Initial value assignment

The VAR...END_VAR construction can be used as shown in table 18 to specify initial values of directly represented variables or symbolically represented single- or multi-element variables.

Initial values can also be specified by using the instance-specific initialization feature provided by the `VAR_CONFIG...END_VAR` construct described in 2.7.1 (table 49, feature 11). Instance-specific initial values always override type-specific initial values.

NOTE The usage of the `VAR_INPUT`, `VAR_OUTPUT`, and `VAR_IN_OUT` constructions is defined in subclause 2.5.

Initial values cannot be given in `VAR_EXTERNAL` declarations.

During initialization of arrays, the rightmost subscript of an array shall vary most rapidly with respect to filling the array from the list of initialization variables.

Parentheses can be used as a repetition factor in array initialization lists, for example, `2 (1, 2, 3)` is equivalent to the initialization sequence `1, 2, 3, 1, 2, 3`.

If the number of initial values given in the initialization list exceeds the number of array entries, the excess (rightmost) initial values shall be ignored. If the number of initial values is less than the number of array entries, the remaining array entries shall be filled with the default initial values for the corresponding data type. In either case, the user shall be warned of this condition during preparation of the program for execution.

When a variable is declared to be of a derived, structured data type as defined in 2.3.3.1, initial values for the elements of the variable can be declared in a parenthesized list following the data type identifier, as shown in table 18. Elements for which initial values are not listed in the initial value list shall have the default initial values declared for those elements in the data type declaration.

When a variable is declared to be a *function block instance*, as defined in 2.5.2.2, initial values for the inputs and any accessible variables of the function block can be declared in a parenthesized list following the assignment operator that follows the function block type identifier as shown in table 18. Elements for which initial values are not listed shall have the default initial values declared for those elements in the function block declaration.

Table 18 - Variable initial value assignment features

No.	Feature/examples	
1 ^a	Initialization of directly represented variables	
	<pre>VAR AT %QX5.1 : BOOL :=1; AT %MW6 : INT := 8 ; END_VAR</pre>	Boolean type, initial value = 1 Initializes a memory word to integer 8
2 ^a	Initialization of directly represented retentive variables	
	<pre>VAR RETAIN AT %QW5 : WORD := 16#FF00 ; END_VAR</pre>	At cold restart, the 8 most significant bits of the 16-bit string at output word 5 are to be initialized to 1 and the 8 least significant bits to 0
3 ^a	Location and initial value assignment to symbolic variables	
	<pre>VAR VALVE_POS AT %QW28 : INT := 100; END_VAR</pre>	Assigns output word 28 to the integer variable <code>VALVE_POS</code> , with an initial value of 100
4 ^a	Array location assignment and initialization	
	<pre>VAR OUTARY AT %QW6 : ARRAY[0..9] OF INT := [10(1)]; END_VAR</pre>	Declares an array of 10 integers to be allocated to contiguous output locations starting at <code>%QW6</code> , each with an initial value of 1

<http://www.china-gauges.com/>

Table 18 - Variable initial value assignment features

No.	Feature/examples	
5	Initialization of symbolic variables	
	<pre>VAR MYBIT : BOOL := 1 ; OKAY : STRING[10] := 'OK'; END_VAR</pre>	<p>Allocates a memory bit to the Boolean variable MYBIT with an initial value of 1</p> <p>Allocates memory to contain a string with a maximum length of 10 characters. After initialization, the string has a length of 2 and contains the two-byte sequence of characters 'OK' (decimal 79 and 75 respectively), in an order appropriate for printing as a character string</p>
6	Array initialization	
	<pre>VAR BITS : ARRAY[0..7] OF BOOL := [1,1,0,0,0,1,0,0] ; TBT : ARRAY [1..2,1..3] OF INT := [1,2,3(4),6] ; END_VAR</pre>	<p>Allocates 8 memory bits to contain initial values BITS[0] := 1, BITS[1] := 1, ..., BITS[6] := 0, BITS[7] := 0.</p> <p>Allocates a 2-by-3 integer array TBT with initial values TBT[1,1] := 1, TBT[1,2] := 2, TBT[1,3] := 4, TBT[2,1] := 4, TBT[2,2] := 4, TBT[2,3] := 6.</p>
7	Retentive array declaration and initialization	
	<pre>VAR RETAIN RTBT : ARRAY(1..2,1..3) OF INT := [1,2,3(4)]; END_VAR</pre>	<p>Declares retentive array RTBT with "cold restart" initial values of: RTBT[1,1] := 1, RTBT[1,2] := 2, RTBT[1,3] := 4, RTBT[2,1] := 4, RTBT[2,2] := 4, RTBT[2,3] := 0.</p>
8	Initialization of structured variables	
	<pre>VAR MODULE_8_CONFIG: ANALOG_16_INPUT_CONFIGURATION := (SIGNAL_TYPE := DIFFERENTIAL, CHANNEL := [4((RANGE := UNIPOLAR_1_5V)), (RANGE:= BIPOLAR_10_V, MIN_SCALE := 0, MAX_SCALE := 500)]); END_VAR</pre>	<p>Initialization of a variable of derived data type (see table 12)</p> <p>This example illustrates the declaration of a non-default initial value for the fifth element of the CHANNEL array of the variable MODULE_8_CONFIG.</p>
9	Initialization of constants	
	<pre>VAR CONSTANT PI : REAL := 3.141592 ; END_VAR</pre>	
10	Initialization of function block instances	
	<pre>VAR TempLoop : PID := (PropBand := 2.5, Integral := T#5s); END_VAR</pre>	<p>Allocates initial values to inputs and outputs of a function block instance</p>
<p>^a Features 1 to 4 can only be used in PROGRAM and VAR_GLOBAL declarations, as defined in 2.5.3 and 2.7.1 respectively.</p>		

http://www.china-gauges.com/

2.5 Program organization units

The program organization units defined in this part of IEC 61131 are the *function*, *function block*, and *program*. These program organization units can be delivered by the manufacturer, or programmed by the user by the means defined in this part of the standard.

Program organization units shall not be *recursive*; that is, the invocation of a program organization unit shall not cause the invocation of another program organization unit of the same type.

The information necessary to determine execution times of program organization units may consist of one or more **implementation-dependent** parameters.

2.5.1 Functions

For the purposes of programmable controller programming languages, a *function* is defined as a program organization unit which, when executed, yields exactly one data element, which is considered to be the function result, and arbitrarily many additional output elements (VAR_OUTPUT and VAR_IN_OUT). As for any data element, the function result can be multi-valued, for example, an array or structure. The invocation of a function can be used in textual languages as an operand in an expression. For example, the SIN and COS functions could be used as shown in figure 4.

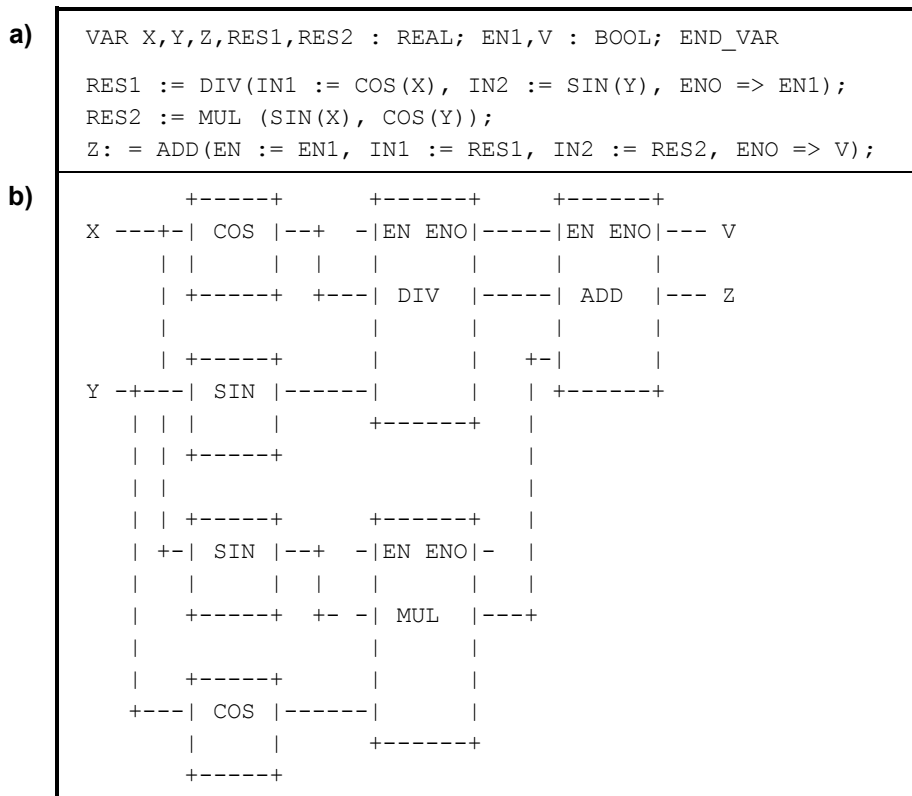

IEC 2474/02

- a) Structured Text (ST) language - see subclause 3.3
- b) Function Block Diagram (FBD) language - see subclause 4.3

NOTE This figure shows two different representations of the same functionality. It is not required to support any automatic transformation between the two forms of representation.

Figure 4 - Examples of function usage

Functions shall contain no internal state information, i.e., invocation of a function with the same arguments (input variables `VAR_INPUT` and in-out variables `VAR_IN_OUT`) shall always yield the same values (output variables `VAR_OUTPUT`, in-out variables `VAR_IN_OUT` and function result). It shall be an **error** if external variables as defined in 2.4.3 cause the violation of this rule.

Any function type which has already been declared can be used in the declaration of another program organization unit, as shown in figure 3.

2.5.1.1 Representation

Functions and their invocation can be represented either graphically or textually.

In the textual languages defined in clause 3 of this standard, the invocation of functions shall be according to the following rules:

- 1) Input argument assignment shall follow the rules given in table 19 a).
- 2) Assignments of output variables of the function shall be either empty or to variables.
- 3) Assignments to `VAR_IN_OUT` arguments shall be variables.
- 4) Assignments to `VAR_INPUT` arguments may be empty (feature 1 of table 19 a)), constants, variables or function calls. In the latter case, the function result is used as the actual argument.

In the graphic languages defined in clause 4 of this standard, functions shall be represented as graphic blocks according to the following rules:

- 5) The form of the block shall be rectangular or square.
- 6) The size and proportions of the block may vary depending on the number of inputs and other information to be displayed.
- 7) The direction of processing through the block shall be from left to right (input variables on the left and output variables on the right).
- 8) The function name or symbol, as specified below, shall be located inside the block.
- 9) Provision shall be made for input and output variable names appearing at the inside left and right sides of the block respectively when the block represents:
 - one of the standard functions defined in 2.5.1.5, when the given graphical form includes the variable names; or
 - any additional function declared as specified in 2.5.1.3.

This usage is subject to the following provisions:

- a) Where no names are given for input variables in standard functions, the default names `IN1`, `IN2`, . . . shall apply in top-to-bottom order.
- b) When a standard function has a single unnamed input, the default name `IN` shall apply.
- c) The default names described above may, but need not appear at the inside left-hand side of the graphic representation.

<http://www.china-gauges.com/>

- 10) An additional input `EN` and/or output `ENO` as specified in 2.5.1.2 may be used. If present, they shall be shown at the uppermost positions at the left and right side of the block, respectively.
- 11) The function result shall be shown at the uppermost position at the right side of the block, except if there is an `ENO` output, in which case the function result shall be shown at the next position below the `ENO` output. Since the name of the function is used for the assignment of its output value as specified in 2.5.1.3, no output variable name shall be shown at the right side of the block.
- 12) Argument connections (including function result) shall be shown by signal flow lines.
- 13) Negation of Boolean signals shall be shown by placing an open circle just outside of the input or output line intersection with the block. In the character set defined in 2.1.1, this shall be represented by the upper case alphabetic "O" as shown in table 19.
- 14) All inputs and outputs (including function result) of a graphically represented function shall be represented by a single line outside the corresponding side of the block, even though the data element may be a multi-element variable.
- 15) Function results and function outputs (`VAR_OUTPUT`) can be connected to a variable, used as input to other function blocks or functions, or can be left unconnected.
- 16) It shall be an **error** if any `VAR_IN_OUT` variable of any function block invocation or function invocation within a POU is not "properly mapped". A `VAR_IN_OUT` variable is "properly mapped" if it is connected graphically at the left, or assigned using the "[:=" operator in a textual invocation, to a variable declared (without the `CONSTANT` qualifier) in a `VAR_IN_OUT`, `VAR`, `VAR_OUT`, or `VAR_EXTERNAL` block of the containing program organization unit, or to a "properly mapped" `VAR_IN_OUT` of another contained function block instance or function invocation.
- 17) A "properly mapped" (see rule 12 above) `VAR_IN_OUT` variable of a function block instance or a function invocation can be connected graphically at the right, or assigned using the "[:=" operator in a textual assignment statement, to a variable declared in a `VAR`, `VAR_OUT` or `VAR_EXTERNAL` block of the containing program organization unit. It shall be an **error** if such a connection would lead to an ambiguous value of the variable so connected.

Table 19 - Graphical negation of Boolean signals

No.	Feature ^{a, b}	Representation
1	Negated input	<pre> +----+ ---O --- +----+ </pre>
2	Negated output	<pre> +----+ ---- O--- +----+ </pre>
<p>^a If either of these features is supported for functions, it shall also be supported for function blocks as defined in 2.5.2, and vice versa.</p> <p>^b The use of these constructs is forbidden for in-out variables.</p>		

Figure 5 illustrates both the graphical and equivalent textual use of functions, including the use of a standard function (ADD) with no defined formal argument names; a standard function (SHL) with defined formal argument names; the same function with additional use of EN input and negated ENO output; and a user-defined function (INC) with defined formal argument names.

Example	Explanation
<pre> +-----+ ADD B--- ----A C--- D--- +-----+ </pre>	Graphical use of ADD function (See 2.5.1.5.2) (FBD language; see 4.3) (No formal variable names)
<pre> A := ADD(B,C,D); </pre>	Textual use of ADD function (ST language; see 3.3)
<pre> +-----+ SHL B--- IN ----A C--- N +-----+ </pre>	Graphical use of SHL function (See 2.5.1.5.3) (FBD language; see 4.3) (Formal argument names)
<pre> A := SHL(IN := B,N := C); </pre>	Textual use of SHL function (ST language; see 3.3)
<pre> +-----+ SHL ENABLE--- EN ENO O--NO_ERR B--- IN ----A C--- N +-----+ </pre>	Graphical use of SHL function (See 2.5.1.5.3) (FBD language; see 4.3) (Formal argument names; use of EN input and negated ENO output)
<pre> A := SHL(EN:=ENABLE, IN:=B, N:=C, NOT ENO => NO_ERR); </pre>	Textual use of SHL function (ST language; see 3.3)
<pre> +-----+ INC ----A X--- V---V ----X +-----+ </pre>	Graphical use of user-defined INC function (FBD language, see 4.3) (Formal argument names for VAR_IN_OUT)
<pre> A := INC(V := X); </pre>	Textual use of INC function (ST language, see 3.3)

Figure 5 - Use of formal argument names

IEC 2475/02

Features for the textual invocation of functions are defined in table 19 a). The textual invocation of a function shall consist of the function name followed by a list of arguments. In the ST language defined in subclause 3.3, the arguments shall be separated by commas and this list shall be delimited on the left and right by parentheses.

In feature 1 of table 19 a) (formal invocation), the argument list has the form of a set of assignments of actual values to the formal argument names (formal argument list), that is:

- 1) assignments of values to input and in-out variables using the " := " operator, and
- 2) assignments of the values of output variables to variables using the " => " operator.

The ordering of arguments in the list shall be insignificant. In feature 1 of table 19 a), any variable not assigned a value in the list shall have the default value, if any, assigned in the function specification, or the default value for the associated data type.

In feature 2 of table 19 a) (non-formal invocation), the argument list shall contain exactly the same number of arguments, in exactly the same order and of the same data types as given in the function definition, except the execution control arguments EN and ENO.

Table 19 a) - Textual invocation of functions for formal and non-formal argument list

No.	Feature				Example In Structured Text (ST) language - see 3.3
	Invocation type	Variable assignment	Variable order	Number of variables	
1	formal	yes	any	any	A := LIMIT(EN:=COND, IN:=B, MX:=5, ENO=>TEMPL);
2 ^a	non-formal	no	fixed	fixed	A := LIMIT(1, B, 5);
^a Feature #2 is required for invocation of any of the standard functions defined in subclause 2.5.1.5 without formal names for one or more input variables, but feature #1 shall be used if EN/ENO is necessary in function invocations.					
NOTE 1 In the example given in feature #1, the MN variable will have the default value 0 (zero).					
NOTE 2 The example given in feature #2 is semantically equivalent to the following invocation with formal variable assignments (feature #1): A := LIMIT(EN := TRUE, MN := 1, IN := B, MX := 5);					

2.5.1.2 Execution control

As shown in table 20, an additional Boolean EN (Enable) input or ENO (Enable Out) output, or both, can be provided by the manufacturer or user according to the declarations

```
VAR_INPUT    EN: BOOL := 1;  END_VAR
VAR_OUTPUT  ENO: BOOL;  END_VAR
```

When these variables are used, the execution of the operations defined by the function shall be controlled according to the following rules:

- 1) If the value of EN is FALSE (0) when the function is invoked, the operations defined by the function body shall not be executed and the value of ENO shall be reset to FALSE (0) by the programmable controller system.
- 2) Otherwise, the value of ENO shall be set to TRUE (1) by the programmable controller system, and the operations defined by the function body shall be executed. These operations can include the assignment of a Boolean value to ENO.
- 3) If any of the errors defined in table E.1 for subclauses of 2.5.1.5 occurs during the execution of one of the standard functions defined in 2.5.1.5, the ENO output of that function shall be reset to FALSE (0) by the programmable controller system, or the manufacturer shall specify other disposition of such an **error** according to the provisions of 1.5.1.
- 4) If the ENO output is evaluated to FALSE (0), the values of all function outputs (VAR_OUTPUT, VAR_IN_OUT and function result) shall be considered to be **implementation-dependent**.

NOTE It is a consequence of these rules that the ENO output of a function must be explicitly examined by the invoking entity if necessary to account for possible error conditions.

Table 20 - Use of EN input and ENO output

No.	Feature	Example ^a
1	Use of EN and ENO Shown in LD (Ladder Diagram) language; see 4.2	<pre> +-----+ ADD_EN + ADD_OK +-----+-----+ EN ENO ---()---+ +-----+-----+ A--- ---C B--- ---C +-----+-----+ </pre>
2	Usage without EN and ENO Shown in FBD (Function Block Diagram) language; see 4.3	<pre> +-----+ A--- + ---C B--- ---C +-----+ </pre>
3	Usage with EN and without ENO Shown in FBD (Function Block Diagram) language; see 4.3	<pre> +-----+ ADD_EN--- EN A--- + ---C B--- ---C +-----+ </pre>
4	Usage without EN and with ENO Shown in FBD (Function Block Diagram) language; see 4.3	<pre> +-----+ ENO ---ADD_OK A--- + ---C B--- ---C +-----+ </pre>
<p>^a The graphical languages chosen for demonstrating the features above are given only as examples. Features, if chosen by a vendor, shall be in effect for all languages supported by the vendor (IL, ST, LD, FBD).</p>		

2.5.1.3 Declaration

Features for the textual and graphical declaration of functions are listed in table 20 a).

As illustrated in figure 6, the textual declaration of a function shall consist of the following elements:

- 1) The keyword FUNCTION, followed by an identifier specifying the name of the function being declared, a colon (:), and the data type of the value to be returned by the function;
- 2) A VAR_INPUT...END_VAR construct as defined in 2.4.3, specifying the names and types of the function's input variables;
- 3) VAR_IN_OUT...END_VAR and VAR_OUTPUT...END_VAR constructs (see F.11 for an example of the use of the latter construct) as defined in 2.4.3, if required, specifying the names and types of the function's in-out and output variables;
- 4) A VAR...END_VAR construct, if required, specifying the names and types of the function's internal variables;

<http://www.china-gauges.com/>

- 5) A *function body*, written in one of the languages defined in this standard, or another programming language as defined in 1.4.3, which specifies the operations to be performed upon the variable(s) in order to assign values dependent on the function's semantics to a variable with the same name as the function, which represents the function result to be returned by the function (function result), as well as to in-out or output variables;
- 6) The terminating keyword `END_FUNCTION`.

If the generic data types given in table 11 are used in the declaration of standard function variables, then the rules for inferring the actual types of the arguments of such functions shall be part of the function definition.

The variable initialization constructs defined in 2.4.3.2 can be used for the declaration of default values of function inputs and initial values of their internal and output variables.

The values of variables which are passed to the function via a `VAR_IN_OUT` construct can be modified from within the function.

As illustrated in figure 6, the graphic declaration of a function shall consist of the following elements:

- 1) The bracketing keywords `FUNCTION . . . END_FUNCTION` or a graphical equivalent.
- 2) A graphic specification of the function name and the names, types and possibly initial values of the function's result and variables (input, output and in-out).
- 3) A specification of the names, types and possibly initial values of the internal variables used in the function, for example, using the `VAR . . . END_VAR` construct.
- 4) A function body as defined above.

The maximum number of function specifications allowed in a particular *resource* is an **implementation-dependent** parameter.

Table 20 a) - Function features

No.	Description	Example
1	In-out variable declaration (textual)	<code>VAR_IN_OUT A: INT; END_VAR</code>
2	In-out variable declaration (graphical)	See figure 6 b)
3	Graphical connection of in-out variable to different variables (graphical)	See figure 6 d)

<http://www.china-gauges.com/>

```

a) FUNCTION SIMPLE_FUN : REAL
    VAR_INPUT
        A,B : REAL ;          (* External interface specification *)
        C : REAL := 1.0;
    END_VAR
    VAR_IN_OUT COUNT : INT ; END_VAR
    VAR COUNTP1 : INT ; END_VAR

    COUNTP1 := ADD(COUNT,1); (*Function body specification *)
    COUNT := COUNTP1 ;
    SIMPLE_FUN := A*B/C;
END_FUNCTION
    
```

NOTE In the above example, the input variable is given a default value of 1.0, as specified in 2.4.3.2, to avoid a "division by zero" error if the input is not specified when the function is invoked, for example, if a graphical input to the function is left unconnected.

```

b) FUNCTION
    +-----+ (* External interface specification *)
    | SIMPLE_FUN |
    REAL----|A          |----REAL
    REAL----|B          |
    REAL----|C          |
    INT-----|COUNT---COUNT|----INT
    +-----+
    (* Function body specification *)
    +----+
    |ADD|---          +-----+
    COUNT--|  |---COUNTP1--| := |---COUNT
    1--|  |          +-----+
    +----+      +----+
            A---| * | +----+
            B---|   | / |---SIMPLE_FUN
            +----+ | |
            C-----| |
            +----+
    END_FUNCTION
    
```

```

c)
....
VAR X,Y,Z,RESULT : REAL;
VAR COUNT1,COUNT2 : INT;
...
RESULT := SIMPLE_FUN (A:=X,B:=Y,C:=Z,COUNT:=COUNT1);
COUNT2 := COUNT1;
...
    
```

```

d)
    +-----+
    | SIMPLE_FUN |
    X----|A          |----RESULT
    Y----|B          |
    Z----|C          |
    COUNT1---|COUNT---COUNT|----COUNT2
    +-----+
    
```

NOTE The effect of this invocation of this function is identical to that in figure 6 c)

- a) Textual declaration in ST language (subclause 3.3)
- b) Graphical declaration in FBD language (subclause 4.3)
- c) Usage of a function in ST language
- d) Usage of a function in FBD language (subclause 4.3)

Figure 6 - Examples of function declarations and usage

2.5.1.4 Typing, overloading, and type conversion

A standard function, function block type, operator, or instruction is said to be *overloaded* when it can operate on input data elements of various types within a generic type designator as defined in 2.2.2. For instance, an overloaded addition function on generic type ANY_NUM can operate on data of types LREAL, REAL, DINT, INT, and SINT.

When a programmable controller system supports an overloaded standard function, function block type, operator, or instruction, this standard function, function block type, operator, or instruction shall apply to all data types of the given generic type which are supported by that system. For example, if a programmable controller system supports the overloaded function ADD and the data types SINT, INT, and REAL, then the system shall support the ADD function on inputs of type SINT, INT, and REAL.

When a function which normally represents an overloaded operator is to be typed, i.e., the types of its inputs and outputs restricted to a particular elementary or derived data type as defined in 2.3, this shall be done by appending an “underline” character followed by the required type, as shown in table 21.

Table 21 - Typed and overloaded functions

No.	Feature	Example
1	Overloaded functions	<pre> +-----+ ADD ANY_NUM----- -----ANY_NUM ANY_NUM----- . ----- . ----- ANY_NUM----- +-----+ </pre>
2 ^a	Typed functions	<pre> +-----+ ADD_INT INT----- -----INT INT----- . ----- . ----- INT----- +-----+ </pre>
NOTE The overloading of non-standard functions or function block types is beyond the scope of this standard.		
^a If feature 2 is supported, the manufacturer shall provide a table of which functions are overloaded and which are typed in the implementation.		

When the type of the result of a standard function defined in 2.5.1.5 is generic, then the actual types of all input variables of the same generic type shall be of the same type as the actual type of the function value in a given *invocation* of the function. If necessary, the type conversion functions defined in 2.5.1.5.1 can be used to meet this requirement. Examples of the application of this rule are given in figures 7 and 8.

Type declaration (ST language - see 3.3)	Usage (FBD language - see 4.3) (ST language - see 3.3)
<pre>VAR A : INT ; B : INT ; C : INT ; END_VAR</pre>	<pre> +----+ A---- + ----C B---- +----+ C := A+B;</pre>
NOTE Type conversion is not required in the example shown above.	
<pre>VAR A : INT ; B : REAL ; C : REAL; END_VAR</pre>	<pre> +-----+ +----+ A---- INT_TO_REAL ---- + ----C B-----+ +-----+ +-----+ C := INT_TO_REAL(A)+B;</pre>
<pre>VAR A : INT ; B : INT ; C : REAL; END_VAR</pre>	<pre> +----+ +-----+ A---- + ---- INT_TO_REAL ----C B---- +-----+ +----+ C := INT_TO_REAL(A+B);</pre>

IEC 2477/02

Figure 7 - Examples of explicit type conversion with overloaded functions

Type declaration (ST language - see 3.3)	Usage (FBD language - see 4.3) (ST language - see 3.3)
<pre>VAR A : INT ; B : INT ; C : INT ; END_VAR</pre>	<pre> +-----+ A--- ADD_INT ----C B--- +-----+ C := ADD_INT(A,B);</pre>
NOTE Type conversion is not required in the example shown above.	
<pre>VAR A : INT ; B : REAL ; C : REAL; END_VAR</pre>	<pre> +-----+ +-----+ A--- INT_TO_REAL ---- ADD_REAL ----C +-----+ B-----+ +-----+ C := ADD_REAL(INT_TO_REAL(A),B);</pre>
<pre>VAR A : INT ; B : INT ; C : REAL; END_VAR</pre>	<pre> +-----+ +-----+ A--- ADD_INT ---- INT_TO_REAL ----C +-----+ B--- +-----+ C := INT_TO_REAL(ADD_INT(A,B));</pre>

IEC 2478/02

Figure 8 - Examples of explicit type conversion with typed functions

2.5.1.5 Standard functions

Definitions of functions common to all programmable controller programming languages are given in this subclause. Where graphical representations of standard functions are shown in this subclause, equivalent textual declarations may be written as specified in 2.5.1.3.

A standard function specified in this subclause to be *extensible* is allowed to have two or more inputs to which the indicated operation is to be applied, for example, extensible addition shall give as its output the sum of all its inputs. The maximum number of inputs of an extensible function is an **implementation-dependent parameter**. The actual number of inputs effective in a formal call of an extensible function is determined by the formal input name with the highest position in the sequence of parameter names.

EXAMPLE 1 The statement

```
X := ADD(Y1, Y2, Y3);
```

is equivalent to

```
X := ADD(IN1 := Y1, IN2 := Y2, IN3 := Y3);
```

EXAMPLE 2 The following statements are equivalent:

```
I := MUX_INT(K:=3, IN0 := 1, IN2 := 2, IN4 := 3);
```

```
I := 0;
```

2.5.1.5.1 Type conversion functions

As shown in table 22, type conversion functions shall have the form **_TO_**, where “*” is the type of the input variable IN, and “**” the type of the output variable OUT, for example, INT_TO_REAL. The effects of type conversions on accuracy, and the types of **errors** that may arise during execution of type conversion operations, are **implementation-dependent parameters**.

Table 22 - Type conversion function features

No.	Graphical form	Usage example
1 ^{a,b,e}	<pre> +-----+ * --- *_TO_* --- ** +-----+ (*) - Input data type, e.g., INT (**) - Output data type, e.g., REAL (*_TO_*) - Function name, e.g., INT_TO_REAL </pre>	A := INT_TO_REAL(B) ;
2 ^c	<pre> +-----+ ANY_REAL--- TRUNC ---ANY_INT +-----+ </pre>	A := TRUNC(B) ;
3 ^d	<pre> +-----+ *-- *_BCD_TO_* ---** +-----+ </pre>	A := WORD_BCD_TO_INT(B) ;
4 ^d	<pre> +-----+ **-- **_TO_BCD_* ---* +-----+ </pre>	A := INT_TO_BCD_WORD(B) ;
NOTE Usage examples are given in the ST language defined in 3.3.		

Table 22 - Type conversion function features

<p>^a A statement of conformance to feature 1 of this table shall include a list of the specific type conversions supported, and a statement of the effects of performing each conversion.</p> <p>^b Conversion from type REAL or LREAL to SINT, INT, DINT or LINT shall round according to the convention of IEC 60559, according to which, if the two nearest integers are equally near, the result shall be the nearest even integer, e.g.:</p> <p>REAL_TO_INT(1.6) is equivalent to 2 REAL_TO_INT(-1.6) is equivalent to -2</p> <p>REAL_TO_INT(1.5) is equivalent to 2 REAL_TO_INT(-1.5) is equivalent to -2</p> <p>REAL_TO_INT(1.4) is equivalent to 1 REAL_TO_INT(-1.4) is equivalent to -1</p> <p>REAL_TO_INT(2.5) is equivalent to 2 REAL_TO_INT(-2.5) is equivalent to -2</p> <p>^c The function TRUNC shall be used for truncation toward zero of a REAL or LREAL, yielding one of the integer types, for instance,</p> <p>TRUNC(1.6) is equivalent to 1 TRUNC(-1.6) is equivalent to -1</p> <p>TRUNC(1.4) is equivalent to 1 TRUNC(-1.4) is equivalent to -1</p> <p>^d The conversion functions *_BCD_TO_* and **_TO_BCD_* shall perform conversions between variables of type BYTE, WORD, DWORD, and LWORD and variables of type USINT, UINT, UDINT and ULINT (represented by "*" and "**" respectively), when the corresponding bit-string variables contain data encoded in BCD format. For example, the value of USINT_TO_BCD_BYTE(25) would be 2#0010_0101, and the value of WORD_BCD_TO_UINT (2#0011_0110_1001) would be 369.</p> <p>^e When an input or output of a type conversion function is of type STRING or WSTRING, the character string data shall conform to the external representation of the corresponding data, as specified in 2.2, in the character set defined in 2.1.1.</p>
--

2.5.1.5.2 Numerical functions

The standard graphical representation, function names, input and output variable types, and function descriptions of functions of a single numeric variable shall be as defined in table 23. These functions shall be overloaded on the defined generic types, and can be typed as defined in 2.5.1.4. For these functions, the types of the input and output shall be the same.

The standard graphical representation, function names and symbols, and descriptions of arithmetic functions of two or more variables shall be as shown in table 24. These functions shall be overloaded on all numeric types, and can be typed as defined in 2.5.1.4.

The accuracy of numerical functions shall be expressed in terms of one or more **implementation-dependent** parameters.

It is an **error** if the result of evaluation of one of these functions exceeds the range of values specified for the data type of the function output, or if division by zero is attempted.

Table 23 - Standard functions of one numeric variable

Graphical form			Usage example
<pre> +-----+ * --- ** --- * +-----+ (*) - Input/Output (I/O) type (**) - Function name </pre>			<pre> A := SIN(B) ; (ST language - see 3.3) </pre>
No.	Function name	I/O type	Description
General functions			
1	ABS	ANY_NUM	Absolute value
2	SQRT	ANY_REAL	Square root
Logarithmic functions			
3	LN	ANY_REAL	Natural logarithm
4	LOG	ANY_REAL	Logarithm base 10
5	EXP	ANY_REAL	Natural exponential
Trigonometric functions			
6	SIN	ANY_REAL	Sine of input in radians
7	COS	ANY_REAL	Cosine in radians
8	TAN	ANY_REAL	Tangent in radians
9	ASIN	ANY_REAL	Principal arc sine
10	ACOS	ANY_REAL	Principal arc cosine
11	ATAN	ANY_REAL	Principal arc tangent

<http://www.china-gauges.com/>

Table 24 - Standard arithmetic functions

Graphical form			Usage example
<pre> +-----+ ANY_NUM --- *** --- ANY_NUM ANY_NUM --- . --- . --- ANY_NUM --- +-----+ </pre> <p>(***) - Name or Symbol</p>			<p>A := ADD(B,C,D) ; or A := B+C+D ;</p>
No. ^{d,e}	Name	Symbol	Description
Extensible arithmetic functions			
12^g	ADD	+	OUT := IN1 + IN2 + ... + INn
13	MUL	*	OUT := IN1 * IN2 * ... * INn
Non-extensible arithmetic functions			
14^g	SUB	-	OUT := IN1 - IN2
15^c	DIV	/	OUT := IN1 / IN2
16^a	MOD		OUT := IN1 modulo IN2
17^b	EXPT	**	Exponentiation: OUT := IN1 ^{IN2}
18^f	MOVE	:=	OUT := IN
<p>NOTE 1 Non-blank entries in the Symbol column are suitable for use as operators in textual languages, as shown in tables 52 and 55.</p> <p>NOTE 2 The notations IN1, IN2, ..., INn refer to the inputs in top-to-bottom order; OUT refers to the output.</p> <p>NOTE 3 Usage examples and descriptions are given in the ST language defined in 3.3.</p>			
<p>^a IN1 and IN2 shall be of generic type ANY_INT for this function. The result of evaluating this function shall be the equivalent of executing the following statements in the ST language as defined in 3.3:</p> <pre>IF (IN2 = 0) THEN OUT:=0 ; ELSE OUT:=IN1 - (IN1/IN2)*IN2 ; END_IF</pre> <p>^b IN1 shall be of type ANY_REAL, and IN2 of type ANY_NUM for this function. The output shall be of the same type as IN1.</p> <p>^c The result of division of integers shall be an integer of the same type with truncation toward zero, for instance, 7/3 = 2 and (-7)/3 = -2.</p> <p>^d When the named representation of a function is supported, this shall be indicated by the suffix "n" in the compliance statement. For example, "12n" represents the notation "ADD".</p> <p>^e When the symbolic representation of a function is supported, this shall be indicated by the suffix "s" in the compliance statement. For example, "12s" represents the notation "+".</p> <p>^f The MOVE function has exactly one input (IN) of type ANY and one output (OUT) of type ANY.</p> <p>^g The generic type of the inputs and outputs of these functions is ANY_MAGNITUDE.</p>			

http://www.china-gauges.com/

2.5.1.5.3 Bit string functions

The standard graphical representation, function names and descriptions of shift functions for a single bit-string variable shall be as defined in table 25. These functions shall be overloaded on all bit-string types, and can be typed as defined in 2.5.1.4.

The standard graphical representation, function names and symbols, and descriptions of bitwise Boolean functions shall be as defined in table 26. These functions shall be extensible, except for NOT, and overloaded on all bit-string types, and can be typed as defined in 2.5.1.4.

Table 25 - Standard bit shift functions

Graphical form		Usage example ^a
<pre> +-----+ *** ANY_BIT --- IN --- ANY_BIT ANY_INT --- N +-----+ (***) - Function Name </pre>		<pre> A := SHL(IN:=B, N:=5) ; (ST language - see 3.3) </pre>
No.	Name	Description
1	SHL	OUT := IN left-shifted by N bits, zero-filled on right
2	SHR	OUT := IN right-shifted by N bits, zero-filled on left
3	ROR	OUT := IN right-rotated by N bits, circular
4	ROL	OUT := IN left-rotated by N bits, circular
NOTE The notation OUT refers to the function output.		
^a It shall be an error if the value of the N input is less than zero.		

2.5.1.5.4 Selection and comparison functions

Selection and comparison functions shall be overloaded on all data types. The standard graphical representations, function names and descriptions of selection functions shall be as shown in table 27.

The standard graphical representation, function names and symbols, and descriptions of comparison functions shall be as defined in table 28. All comparison functions (except NE) shall be extensible.

Comparisons of bit string data shall be made bitwise from the most significant to the least significant bit, and shorter bit strings shall be considered to be filled on the left with zeros when compared to longer bit strings; that is, comparison of bit string variables shall have the same result as comparison of unsigned integer variables.

Table 26 - Standard bitwise Boolean functions

Graphical form		Usage examples	
<pre> +-----+ ANY_BIT --- *** --- ANY_BIT ANY_BIT --- : --- : --- ANY_BIT --- +-----+ </pre> <p>(***) - Name or symbol</p>		<pre> A := AND(B,C,D) ; </pre> <p>or</p> <pre> A := B & C & D ; </pre>	
No. ^{a,b}	Name	Symbol	Description
5	AND	& (NOTE 1)	OUT := IN1 & IN2 & ... & INn
6	OR	>=1 (NOTE 2)	OUT := IN1 OR IN2 OR ... OR INn
7	XOR	=2k+1 (NOTE 2)	OUT := IN1 XOR IN2 XOR ... XOR INn
8	NOT		OUT := NOT IN1 (NOTE 4)
<p>NOTE 1 This symbol is suitable for use as an operator in textual languages, as shown in tables 52 and 55.</p> <p>NOTE 2 This symbol is not suitable for use as an operator in textual languages.</p> <p>NOTE 3 The notations IN1, IN2, ..., INn refer to the inputs in top-to-bottom order; OUT refers to the output.</p> <p>NOTE 4 Graphic negation of signals of type BOOL can also be accomplished as shown in table 19.</p> <p>NOTE 5 Usage examples and descriptions are given in the ST language defined in 3.3.</p>			
<p>^a When the named representation of a function is supported, this shall be indicated by the suffix "n" in the compliance statement. For example, "5n" represents the notation "AND".</p> <p>^b When the symbolic representation of a function is supported, this shall be indicated by the suffix "s" in the compliance statement. For example, "5s" represents the notation "&".</p>			

Table 27 - Standard selection functions^d

No.	Graphical form	Explanation/example
1	<pre> +-----+ SEL +-----+ BOOL-- G --ANY ANY--- IN0 ANY--- IN1 +-----+</pre>	<p>Binary selection^c:</p> <p>OUT := IN0 if G = 0 OUT := IN1 if G = 1</p> <p>EXAMPLE: A := SEL (G:=X, IN0:=5, IN1:=5) ;</p>
2a	<pre> +-----+ MAX +-----+ ANY_ELEMENTARY-- --ANY_ELEMENTARY : --- ANY_ELEMENTARY-- +-----+</pre>	<p>Extensible maximum function:</p> <p>OUT := MAX (IN1, IN2, ..., INn)</p> <p>EXAMPLE: A := MAX (B, C, D) ;</p>
2b	<pre> +-----+ MIN +-----+ ANY_ELEMENTARY-- --ANY_ELEMENTARY : --- ANY_ELEMENTARY-- +-----+</pre>	<p>Extensible minimum function:</p> <p>OUT := MIN (IN1, IN2, ..., INn)</p> <p>EXAMPLE: A := MIN (B, C, D) ;</p>
3	<pre> +-----+ LIMIT +-----+ ANY_ELEMENTARY-- MN --ANY_ELEMENTARY ANY_ELEMENTARY-- IN ANY_ELEMENTARY-- MX +-----+</pre>	<p>Limiter:</p> <p>OUT := MIN (MAX (IN, MN), MX)</p> <p>EXAMPLE: A := LIMIT (IN:=B, MN:=0, MX:=5) ;</p>
4 ^e	<pre> +-----+ MUX +-----+ ANY_INT-- K ----ANY ANY----- : ----- ANY----- +-----+</pre>	<p>Extensible multiplexer^{a, b, c}:</p> <p>Select one of N inputs depending on input K</p> <p>EXAMPLE: A := MUX (0, B, C, D); would have the same effect as A := B ;</p>
NOTE 1 The notations IN1, IN2, ..., INn refer to the inputs in top-to-bottom order; OUT refers to the output.		
NOTE 2 Usage examples and descriptions are given in the ST language defined in 3.3.		
<p>^a The unnamed inputs in the MUX function shall have the default names IN0, IN1, ..., INn-1 in top-to-bottom order, where n is the total number of these inputs. These names may, but need not, be shown in the graphical representation.</p> <p>^b The MUX function can be <i>typed</i> as defined in 2.5.1.4 in the form MUX_*_**, where * is the type of the K input and ** is the type of the other inputs and the output.</p> <p>^c It is allowed, but not required, that the manufacturer support selection among variables of <i>derived data types</i>, as defined in 2.3.3, in order to claim compliance with this feature.</p> <p>^d It is an error if the inputs and the outputs to one of these functions are not all of the same actual data type, with the exception of the G input of the SEL function and the K input of the MUX function.</p> <p>^e It is an error if the actual value of the K input of the MUX function is not within the range {0..n-1}.</p>		

http://www.china-gauges.com

Table 28 - Standard comparison functions

Graphical form		Usage examples	
<pre> +-----+ ANY_ELEMENTARY -- *** --- BOOL : -- ANY_ELEMENTARY -- +-----+ (***) - Name or Symbol </pre>		<pre> A := GT(B,C,D) ; or A := (B>C) & (C>D) ; </pre>	
No.	Name ^a	Symbol ^b	Description
5	GT	>	Decreasing sequence: OUT := (IN1>IN2) & (IN2>IN3) & ... & (INn-1 > INn)
6	GE	>=	Non-increasing sequence: OUT := (IN1>=IN2) & (IN2>=IN3) & ... & (INn-1 >= INn)
7	EQ	=	Equality: OUT := (IN1=IN2) & (IN2=IN3) & ... & (INn-1 = INn)
8	LE	<=	Monotonic sequence: OUT := (IN1<=IN2) & (IN2<=IN3) & ... & (INn-1 <= INn)
9	LT	<	Increasing sequence: OUT := (IN1<IN2) & (IN2<IN3) & ... & (INn-1 < INn)
10	NE	<>	Inequality (non-extensible) OUT := (IN1 <> IN2)
<p>NOTE 1 The notations IN1, IN2, ..., INn refer to the inputs in top-to-bottom order; OUT refers to the output.</p> <p>NOTE 2 All the symbols shown in this table are suitable for use as operators in textual languages, as shown in tables 52 and 55.</p> <p>NOTE 3 Usage examples and descriptions are given in the ST language defined in 3.3.</p>			
<p>^a When the named representation of a function is supported, this shall be indicated by the suffix "n" in the compliance statement. For example, "5n" represents the notation "GT".</p> <p>^b When the symbolic representation of a function is supported, this shall be indicated by the suffix "s" in the compliance statement. For example, "5s" represents the notation ">".</p>			

2.5.1.5.5 Character string functions

All the functions defined in 2.5.1.5.4 shall be applicable to character strings. For the purposes of comparison of two strings of unequal length, the shorter string shall be considered to be extended on the right to the length of the longer string by characters with the value zero. Comparison shall proceed from left to right, based on the numeric value of the character codes in the character set defined in 2.1.1. For example, the character string 'Z' shall be greater than the character string 'AZ', and 'AZ' shall be greater than 'ABC'.

The standard graphical representations, function names and descriptions of additional functions of character strings shall be as shown in table 29. For the purpose of these operations, character positions within the string shall be considered to be numbered 1, 2, ..., L, beginning with the leftmost character position, where L is the length of the string.

It shall be an **error** if:

- the actual value of any input designated as ANY_INT in table 29 is less than zero;
- evaluation of the function results in an attempt to (1) access a non-existent character position in a string, or (2) produce a string longer than the implementation-dependent maximum string length.

Table 29 - Standard character string functions

No.	Graphical form ^a	Explanation/example
1	<pre> +-----+ ANY_STRING-- LEN --ANY_INT +-----+ </pre>	<p>String length function</p> <p>Example: A := LEN('ASTRING'); is equivalent to A := 7;</p>
2	<pre> +-----+ LEFT ANY_STRING-- IN --ANY_STRING ANY_INT----- L +-----+ </pre>	<p>Leftmost L characters of IN</p> <p>Example: A := LEFT(IN:='ASTR',L:=3); is equivalent to A := 'AST' ;</p>
3	<pre> +-----+ RIGHT ANY_STRING-- IN --ANY_STRING ANY_INT----- L +-----+ </pre>	<p>Rightmost L characters of IN</p> <p>Example: A := RIGHT(IN:='ASTR',L:=3); is equivalent to A := 'STR' ;</p>
4	<pre> +-----+ MID ANY_STRING-- IN --ANY_STRING ANY_INT----- L ANY_INT----- P +-----+ </pre>	<p>L characters of IN, beginning at the P-th</p> <p>Example: A := MID(IN:='ASTR',L:=2,P:=2); is equivalent to A := 'ST' ;</p>
5	<pre> +-----+ CONCAT ANY_STRING--- --ANY_STRING : --- ANY_STRING--- +-----+ </pre>	<p>Extensible concatenation</p> <p>Example: A := CONCAT('AB','CD','E') ; is equivalent to A := 'ABCDE' ;</p>
6	<pre> +-----+ INSERT ANY_STRING-- IN1 --ANY_STRING ANY_STRING-- IN2 ANY_INT----- P +-----+ </pre>	<p>Insert IN2 into IN1 after the P-th character position</p> <p>Example: A:=INSERT(IN1:='ABC',IN2:='XY',P=2);); is equivalent to A := 'ABXYC' ;</p>
7	<pre> +-----+ DELETE ANY_STRING-- IN --ANY_STRING ANY_INT----- L ANY_INT----- P +-----+ </pre>	<p>Delete L characters of IN, beginning at the P-th character position</p> <p>Example: A := DELETE(IN:='ABXYC',L:=2, P:=3) ; is equivalent to A := 'ABC' ;</p>

<http://www.china-gauges.com/>

Table 29 - Standard character string functions

No.	Graphical form ^a	Explanation/example
8	<pre> +-----+ REPLACE ANY_STRING-- IN1 --ANY_STRING ANY_STRING-- IN2 ANY_INT----- L ANY_INT----- P +-----+</pre>	<p>Replace L characters of IN1 by IN2 starting at the P-th character position</p> <p>Example: <pre> A := REPLACE(IN1 := 'ABCDE', IN2 := 'X', L := 2, P := 3) ; </pre> is equivalent to <pre> A := 'ABXE' ; </pre> </p>
9	<pre> +-----+ FIND ANY_STRING-- IN1 --ANY_INT ANY_STRING-- IN2 +-----+</pre>	<p>Find the character position of the beginning of the first occurrence of IN2 in IN1. If no occurrence of IN2 is found, then OUT := 0.</p> <p>Example: <pre> A := FIND(IN1 := 'ABCBC', IN2 := 'BC') ; </pre> is equivalent to A := 2 ;</p>
<p>NOTE The examples in this table are given in the Structured Text (ST) language defined in 3.3.</p>		

2.5.1.5.6 Functions of time data types

In addition to the comparison and selection functions defined in 2.5.1.5.4, the combinations of input and output time data types shown in table 30 shall be allowed with the associated functions.

It shall be an **error** if the result of evaluating one of these functions exceeds the **implementation-dependent** range of values for the output data type.

Table 30 - Functions of time data types

Numeric and concatenation functions					
No.	Name	Symbol	IN1	IN2	OUT
1a ^{c,d}	ADD	+	TIME	TIME	TIME
1b ^{c,d}	ADD_TIME	+	TIME	TIME	TIME
2a	ADD ^b	+ ^b	TIME_OF_DAY	TIME	TIME_OF_DAY
2b	ADD_TOD_TIME	+ ^b	TIME_OF_DAY	TIME	TIME_OF_DAY
3a	ADD ^b	+ ^b	DATE_AND_TIME	TIME	DATE_AND_TIME
3b	ADD_DT_TIME	+ ^b	DATE_AND_TIME	TIME	DATE_AND_TIME
4a ^{c,d}	SUB	-	TIME	TIME	TIME
4b ^{c,d}	SUB_TIME	-	TIME	TIME	TIME
5a	SUB ^b	- ^b	DATE	DATE	TIME
5b	SUB_DATE_DATE	- ^b	DATE	DATE	TIME
6a	SUB ^b	- ^b	TIME_OF_DAY	TIME	TIME_OF_DAY
6b	SUB_TOD_TIME	- ^b	TIME_OF_DAY	TIME	TIME_OF_DAY
7a	SUB ^b	- ^b	TIME_OF_DAY	TIME_OF_DAY	TIME

Table 30 - Functions of time data types

Numeric and concatenation functions					
No.	Name	Symbol	IN1	IN2	OUT
7b	SUB_TOD_TOD	- ^b	TIME_OF_DAY	TIME_OF_DAY	TIME
8a	SUB ^b	- ^b	DATE_AND_TIME	TIME	DATE_AND_TIME
8b	SUB_DT_TIME	- ^b	DATE_AND_TIME	TIME	DATE_AND_TIME
9a	SUB ^b	- ^b	DATE_AND_TIME	DATE_AND_TIME	TIME
9b	SUB_DT_DT	- ^b	DATE_AND_TIME	DATE_AND_TIME	TIME
10a	MUL ^b	* ^b	TIME	ANY_NUM	TIME
10b	MULTIME	* ^b	TIME	ANY_NUM	TIME
11a	DIV ^b	/ ^b	TIME	ANY_NUM	TIME
11b	DIVTIME	/ ^b	TIME	ANY_NUM	TIME
12	CONCAT_DATE_TOD		DATE	TIME_OF_DAY	DATE_AND_TIME
Type conversion functions					
13 ^a	DT_TO_TOD				
14 ^a	DT_TO_DATE				
<p>NOTE 1 Non-blank entries in the Symbol column are suitable for use as operators in textual languages, as shown in tables 52 and 55.</p> <p>NOTE 2 The notations IN1, IN2, ..., IN_n refer to the inputs in top-to-bottom order; OUT refers to the output.</p> <p>NOTE 3 It is possible to type the functions MULTIME and DIVTIME, e.g., the operands of MULTIME_REAL would be of type TIME and REAL, respectively.</p> <p>NOTE 4 The effects of conversion between time data types and types STRING and WSTRING are defined in footnote (e) of table 22.</p> <p>NOTE 5 The effects of type conversions between time data types and other data types not defined in this table are implementation-dependent.</p>					
<p>^a The type conversion functions shall have the effect of "extracting" the appropriate data, e.g., the ST language statements</p> <pre>X := DT#1986-04-28-08:40:00 ; Y := DT_TO_TOD(X) ; W := DT_TO_DATE(X) ;</pre> <p>shall have the same result as the statements</p> <pre>X := DT#1986-04-28-08:40:00 ; W := DATE#1986-04-28 ; Y := TIME_OF_DAY#08:40:00 ;</pre> <p>^b This usage is deprecated and will not be included in future editions of this standard.</p> <p>^c When the named representation of a function is supported, this shall be indicated by the suffix "n" in the compliance statement. For example, "1n" represents the notation "ADD".</p> <p>^d When the symbolic representation of a function is supported, this shall be indicated by the suffix "s" in the compliance statement. For example, "1s" represents the notation "+".</p>					

http://www.china-gauges.com/

2.5.1.5.7 Functions of enumerated data types

The selection and comparison functions listed in table 31 can be applied to inputs which are of an enumerated data type as defined in 2.3.3.1.

Table 31 - Functions of enumerated data types

No.	Name	Symbol	Feature No. in tables 27 and 28
1	SEL		
2	MUX		4
3 ^a	EQ	=	7
4 ^a	NE		10
NOTE The provisions of NOTES 1-2 of table 28 apply to this table.			
^a The provisions of footnotes a and b of table 28 apply to this feature.			

2.5.2 Function blocks

For the purposes of programmable controller programming languages, a *function block* is a program organization unit which, when executed, yields one or more values. Multiple, named *instances* (copies) of a function block can be created. Each instance shall have an associated identifier (the *instance name*), and a data structure containing its output and internal variables, and, depending on the implementation, values of or references to its input variables. All the values of the output variables and the necessary internal variables of this data structure shall persist from one execution of the function block to the next; therefore, invocation of a function block with the same arguments (input variables) need not always yield the same output values.

Only the input and output variables shall be accessible outside of an instance of a function block, i.e., the function block's internal variables shall be hidden from the user of the function block.

Execution of the operations of a function block shall be invoked as defined in clause 3 for textual languages, according to the rules of network evaluation given in clause 4 for graphic languages, or under the control of sequential function chart (SFC) elements as defined in 2.6.

Any function block type which has already been declared can be used in the declaration of another function block type or program type as shown in figure 3.

The scope of an instance of a function block shall be local to the program organization unit in which it is instantiated, unless it is declared to be global in a VAR_GLOBAL block as defined in 2.7.1.

As illustrated in 2.5.2.2, the instance name of a function block instance can be used as the input to a function or function block if declared as an input variable in a VAR_INPUT declaration, or as an input/output variable of a function block in a VAR_IN_OUT declaration, as defined in 2.4.3.

The maximum number of function block types and instantiations for a given *resource* are **implementation-dependent** parameters.

2.5.2.1 Representation

As illustrated in figure 9, an instance of a function block can be created *textually*, by declaring a data element using the declared function block type in a VAR...END_VAR construct, identically to the use of a structured data type, as defined in 2.4.3.

As further illustrated in figure 9, an instance of a function block can be created *graphically*, by using a graphic representation of the function block, with the function block type name inside the block, and the instance name above the block, following the rules for representation of functions given in 2.5.1.1.

As shown in figure 9, input and output variables of an instance of a function block can be represented as elements of structured data types as defined in 2.3.13.

If either of the two graphical negation features defined in table 19 is supported for function blocks, it shall also be supported for functions as defined in 2.5.1, and vice versa.

Graphical (FBD language)	Textual (ST language)
<pre> FF75 +-----+ SR %IX1--- S1 Q1 ---%QX3 %IX2--- R +-----+ </pre>	<pre> VAR FF75: SR; END_VAR (* Declaration *) FF75(S1:=%IX1, R:=%IX2); (* Invocation *) %QX3 := FF75.Q1 ; (* Assign Output *) </pre>
<pre> MyTon +-----+ +-----+ TON a-- NE ---O EN ENO -- b-- r-- IN Q O-out +-----+ -- PT ET -- +-----+ </pre>	<pre> VAR a,b,r,out : BOOL; MyTon : TON; END_VAR MyTon(EN := NOT (a <> b), IN := r, NOT Q => out); </pre>

IEC 2479/02

Figure 9 - Function block instantiation examples

Assignment of a value to an output variable of a function block is not allowed except from within the function block. The assignment of a value to the input of a function block is permitted only as part of the invocation of the function block. Unassigned or unconnected inputs of a function block shall keep their initialized values or the values from the latest previous invocation, if any. Allowable usages of function block inputs and outputs are summarized in table 32, using the function block FF75 of type SR shown in figure 9. The examples are shown in the ST language.

Table 32 - Examples of function block I/O variable usage

Usage	Inside function block	Outside function block
Input read	IF IN1 THEN ...	Not allowed (Notes 1 and 2)
Input assignment	Not allowed (Note 1)	FB_INST (IN1:=A, IN2:=B);
Output read	OUT := OUT AND NOT IN2;	C := FB_INST.OUTPUT;
Output assignment	OUT := 1;	Not Allowed (Note 1)
In-out read	IF INOUT THEN ...	IF FB1.INOUT THEN...
In-out assignment	INOUT := OUT OR IN1; (Note 3)	FB_INST (INOUT:=D);
<p>NOTE 1 Those usages listed as “not allowed” in this table could lead to implementation-dependent, unpredictable side effects.</p> <p>NOTE 2 Reading and writing of input, output and internal variables of a function block may be performed by the “communication function”, “operator interface function”, or the “programming, testing, and monitoring functions” defined in IEC 61131-1.</p> <p>NOTE 3 As illustrated in 2.5.2.2, modification within the function block of a variable declared in a VAR_IN_OUT block is permitted.</p>		

2.5.2.1a) Use of EN and ENO in function blocks

As shown in table 20 for functions, for function blocks an additional Boolean EN (Enable) input or ENO (Enable Out) output, or both, can also be provided by the manufacturer or user according to the declarations

```
VAR_INPUT    EN: BOOL := 1;    END_VAR
VAR_OUTPUT   ENO: BOOL;    END_VAR
```

When these variables are used, the execution of the operations defined by the function block shall be controlled according to the following rules:

- 1) If the value of EN is FALSE (0) when the function block instance is invoked, the assignments of actual values to the function block inputs may or may not be made in an **implementation-dependent** fashion, the operations defined by the function block body shall not be executed and the value of ENO shall be reset to FALSE (0) by the programmable controller system.
- 2) Otherwise, the value of ENO shall be set to TRUE (1) by the programmable controller system, the assignments of actual values to the function block inputs shall be made and the operations defined by the function block body shall be executed. These operations can include the assignment of a Boolean value to ENO.
- 3) If the ENO output is evaluated to FALSE (0), the values of the function block outputs (VAR_OUTPUT) keep their states from the previous invocation.

NOTE It is a consequence of these rules that the ENO output of a function block must be explicitly examined by the invoking entity if necessary to account for possible error conditions.

EXAMPLES The figures below illustrate the use of EN and ENO in association with the standard TP, TON and TOF blocks (represented by T**) defined in subclause 2.5.2.3.4, and the CTU and CTD blocks (represented by CT*) defined in subclause 2.5.2.3.3. In accordance with the above rules, a FALSE value of the EN input may be used to “freeze” the operation of the associated function block; that is, the output values do not change irrespective of changes in any of the other input values. When the EN input value becomes TRUE, normal

operation of the function block may resume. The value of the ENO output is FALSE after each evaluation of the function block for which the EN input is FALSE. When EN is TRUE, a TRUE value of ENO reflects a normal evaluation of the block, and a FALSE value of ENO may be used to indicate an implementation-dependent error condition.

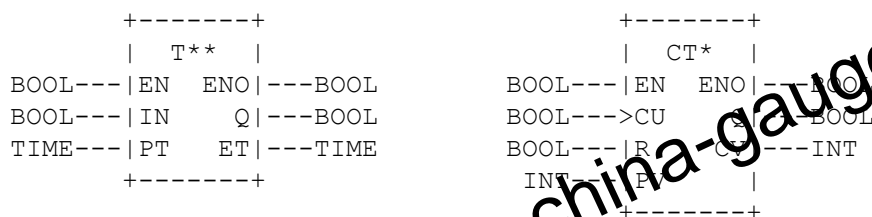

2.5.2.2 Declaration

As illustrated in figure 10, a function block shall be declared textually or graphically in the same manner as defined for functions in 2.5.1.3, with the differences described below and summarized in table 33:

- 1) The delimiting keywords for declaration of function blocks shall be `FUNCTION_BLOCK...END_FUNCTION_BLOCK`.
- 2) The `RETAIN` qualifier defined in 2.4.3 can be used for internal and output variables of a function block, as shown in features 1, 2, and 3 in table 33.
- 3) The values of variables which are passed to the function block via a `VAR_EXTERNAL` construct can be modified from within the function block, as shown in feature 10 of table 33.
- 4) The output values of a function block instance whose name is passed into the function block via a `VAR_INPUT`, `VAR_IN_OUT`, or `VAR_EXTERNAL` construct can be accessed, but not modified, from within the function block, as shown in features 5, 6, and 7 of table 33.
- 5) A function block whose instance name is passed into the function block via a `VAR_IN_OUT` or `VAR_EXTERNAL` construction can be invoked from inside the function block, as shown in features 6 and 7 of table 33.
- 6) In textual declarations, the `R_EDGE` and `F_EDGE` qualifiers can be used to indicate an edge-detection function on Boolean inputs. This shall cause the implicit declaration of a function block of type `R_TRIG` or `F_TRIG`, respectively, as defined in 2.5.2.3.2, to perform the required edge detection. For an example of this construction, see features 8a and 8b of table 33 and the accompanying NOTE.
- 7) The construction illustrated in features 9a and 9b of table 33 shall be used in graphical declarations for rising and falling edge detection. When the character set defined in 2.1.1 is used, the "greater than" (>) or "less than" (<) character shall be in line with the edge of the function block. When graphic or semigraphic representations are employed, the notation of IEC 60617-12 for dynamic inputs shall be used.
- 8) If the generic data types given in table 11 are used in the declaration of standard function block inputs and outputs, then the rules for inferring the actual types of the outputs of such function block types shall be part of the function block type definition. In textual invocations of such function blocks assignments of the outputs to variables shall be made directly in the invocation statement (using the operator '=>').
- 9) The asterisk notation (feature No. 10 in table 15) can be used in the declaration of internal variables of a function block.
- 10) EN/ENO inputs and outputs shall be declared and used as described in 2.5.1.2a).
- 11) It shall be an **error** if no value is specified for: (i) an in-out variable of a function block instance; (ii) a function block instance used as an input variable of another function block instance.

<http://www.china-gauges.com/>

As illustrated in figure 12, only variables or function block instance names can be passed into a function block via the VAR_IN_OUT construct, i.e., function or function block outputs cannot be passed via this construction. This is to prevent the inadvertent modifications of such outputs. However, "cascading" of VAR_IN_OUT constructions is permitted, as illustrated in figure 12 c).

```
(* a) Textual declaration in ST language (see 3.3) *)
FUNCTION_BLOCK DEBOUNCE
(** External Interface **)
VAR_INPUT
  IN : BOOL ; (* Default = 0 *)
  DB_TIME : TIME := t#10ms ; (* Default = t#10ms *)
END_VAR
VAR_OUTPUT OUT : BOOL ; (* Default = 0 *)
  ET_OFF : TIME ; (* Default = t#0s *)
END_VAR
VAR DB_ON : TON ; (** Internal Variables **)
  DB_OFF : TON ; (** and FB Instances **)
  DB_FF : SR ;
END_VAR

(** Function Block Body **)
DB_ON(IN := IN, PT := DB_TIME) ;
DB_OFF(IN := NOT IN, PT:=DB_TIME) ;
DB_FF(S1 :=DB_ON.Q, R := DB_OFF.Q) ;
OUT := DB_FF.Q ;
ET_OFF := DB_OFF.ET ;

END_FUNCTION_BLOCK

(* b) Graphical declaration in FBD language (see 4.3) *)
FUNCTION_BLOCK
(** External Interface **)
+-----+
| DEBOUNCE |
+-----+
BOOL---| IN      OUT|---BOOL
TIME---| DB_TIME ET_OFF|---TIME
+-----+

(** Function Block Body **)
+-----+ +-----+
| TON | | SR |
+-----+ +-----+
IN---+-----| IN Q|-----| S1 Q|---OUT
| +---| PT ET| +---| R |
| | +-----+ | +-----+
| | DB_OFF | | |
| | +-----+ |
| | | TON | |
+---|--O| IN Q|---+
DB_TIME---+---| PT ET|-----ET_OFF
+-----+
END_FUNCTION_BLOCK
```

IEC 2480/02

Figure 10 - Examples of function block declarations

Table 33 - Function block declaration and usage features

No.	Description	Example
1a	RETAIN qualifier on internal variables	VAR RETAIN X : REAL ; END_VAR
1b	NON_RETAIN qualifier on internal variables	VAR NON_RETAIN X : REAL ; END_VAR
2a	RETAIN qualifier on output variables	VAR_OUTPUT RETAIN X : REAL ; END_VAR
2b	RETAIN qualifier on input variables	VAR_INPUT RETAIN X : REAL ; END_VAR
2c	RETAIN qualifier on output variables	VAR_OUTPUT NON_RETAIN X : REAL ; END_VAR
2d	RETAIN qualifier on input variables	VAR_INPUT NON_RETAIN X : REAL ; END_VAR
3a	RETAIN qualifier on internal function blocks	VAR RETAIN TMR1: TON ; END_VAR
3b	NON_RETAIN qualifier on internal function blocks	VAR NON_RETAIN TMR1: TON ; END_VAR
4a	VAR_IN_OUT declaration (textual)	VAR_IN_OUT A: INT ; END_VAR
4b	VAR_IN_OUT declaration and usage (graphical)	See figure 12
4c	VAR_IN_OUT declaration with assignment to different variables (graphical)	See figure 12d
5a	Function block instance name as input (textual)	VAR_INPUT I_TMR: TON ; END_VAR EXPIRED := I_TMR.Q; (* Note 1 *)
5b	Function block instance name as input (graphical)	See figure 11a
6a	Function block instance name as VAR_IN_OUT (textual)	VAR_IN_OUT IO_TMR: TOF ; END_VAR IO_TMR(IN:=A_VAR, PT:=T#10S); EXPIRED := IO_TMR.Q; (* Note 1 *)
6b	Function block instance name as VAR_IN_OUT (graphical)	See figure 11b
7a	Function block instance name as external variable (textual)	VAR_EXTERNAL EX_TMR : TOF ; END_VAR EX_TMR(IN:=A_VAR, PT:=T#10S); EXPIRED := EX_TMR.Q; (* Note 1 *)
7b	Function block instance name as external variable (graphical)	See figure 11c
8a 8b	Textual declaration of: rising edge inputs falling edge inputs	FUNCTION_BLOCK AND_EDGE (* Note 2 *) VAR_INPUT X : BOOL R_EDGE; Y : BOOL F_EDGE; END_VAR VAR_OUTPUT Z : BOOL ; END_VAR Z := X AND Y ; (* ST language example *) END_FUNCTION_BLOCK (*- see 3.3 *)
9a 9b	Graphical declaration of: rising edge inputs falling edge inputs	FUNCTION_BLOCK (* Note 2 *) +-----+ (* External interface *) AND_EDGE BOOL---->X Z ---BOOL BOOL----<Y +-----+ +----+ (* Function block body *) X--- & ---Z (* FBD language example *) Y--- (* - see 4.3 *) +----+ END_FUNCTION_BLOCK
10a	VAR_EXTERNAL declarations within function block type declarations	

Table 33 - Function block declaration and usage features

No.	Description	Example
10b	VAR_EXTERNAL CONSTANT declarations within function block type declarations	
11	VAR_TEMP declarations (see 2.4.3) within function block type declarations	
NOTE 1	<p>It is assumed in these examples that the variables EXPIRED and END_VAR have been declared of type BOOL.</p> <p>NOTE 2 The declaration of function block AND_EDGE in the above examples is equivalent to:</p> <pre> FUNCTION_BLOCK AND_EDGE VAR INPUT X : BOOL; Y : BOOL; END_VAR VAR X_TRIG : R_TRIG ; Y_TRIG : F_TRIG ; END_VAR X_TRIG(CLK := X); Y_TRIG(CLK := Y); Z := X_TRIG.Q AND Y_TRIG.Q; END_FUNCTION_BLOCK </pre> <p>See 2.5.2.3.2 for the definition of the edge detection function blocks R_TRIG and F_TRIG.</p>	

<http://www.china-gauges.com/>

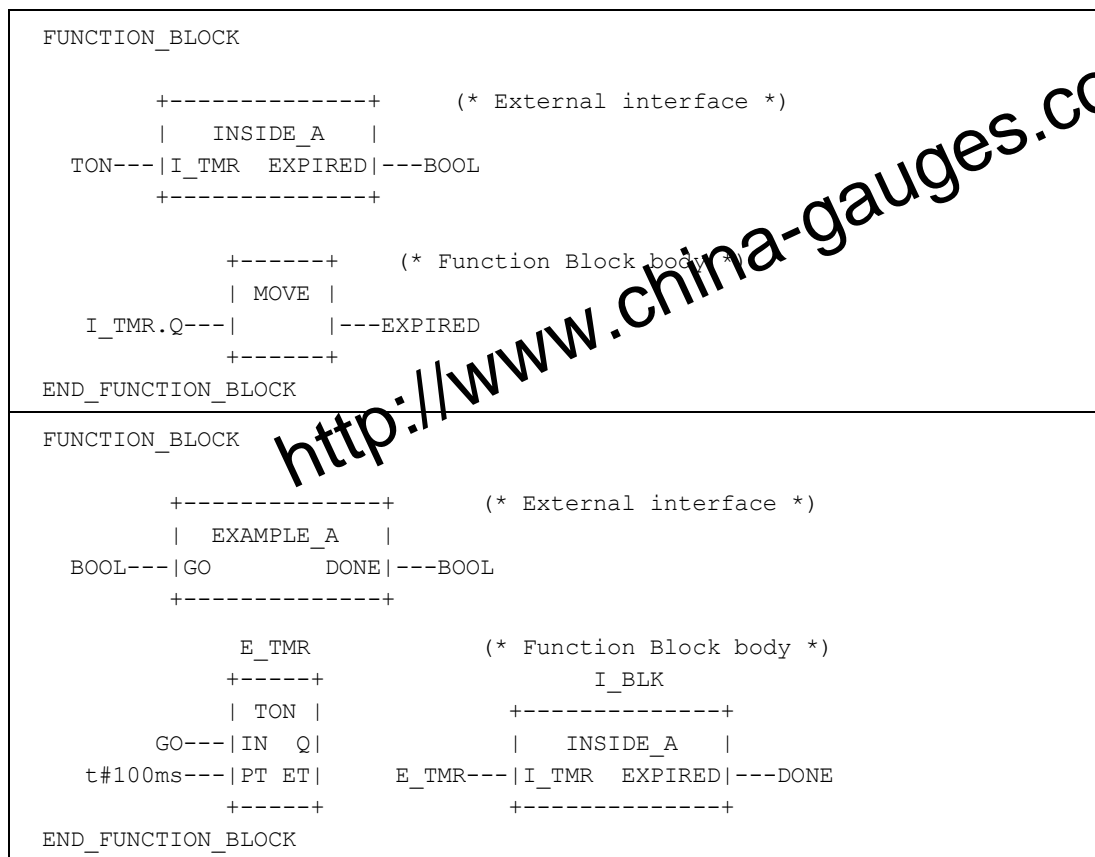

IEC 2481/02

NOTE I_TMR is not represented graphically in this figure since this would imply invocation of I_TMR within INSIDE_A, which is forbidden by rules 4) and 5) of 2.5.2.2. See also feature. 5 a) of table 33.

**Figure 11 a) - Graphical use of a function block name as an input variable
(table 33, feature 5b)**

```

FUNCTION_BLOCK
+-----+ (* External interface *)
|  INSIDE_B  |
TON---|I_TMR----I_TMR|---TON
BOOL--|TMR_GO EXPIRED|---BOOL
+-----+

      I_TMR      (* Function Block body *)
+-----+
|  TON  |
TMR_GO--|IN  Q|---EXPIRED
|PT ET|
+-----+
END_FUNCTION_BLOCK

FUNCTION_BLOCK

+-----+ (* External interface *)
|  EXAMPLE_B  |
BOOL---|GO      DONE|---BOOL
+-----+

      E_TMR      (* Function Block body *)
+-----+
|  TON  |
|IN  Q|
t#100ms---|PT ET|
+-----+

      I_BLK
+-----+
|  INSIDE_B  |
E_TMR---|I_TMR----I_TMR|
GO-----|TMR_GO EXPIRED|---DONE
+-----+
END_FUNCTION_BLOCK
    
```

IEC 2482/02

Figure 11 b) - Graphical use of a function block name as an in-out variable (table 33, feature 6b)



```

FUNCTION_BLOCK
+-----+          (* External interface *)
|  INSIDE_C  |
BOOL--|TMR_GO EXPIRED|---BOOL
+-----+

VAR_EXTERNAL X_TMR : TON ; END_VAR

          X_TMR          (* Function Block body *)
+-----+
|  TON  |
TMR_GO---| IN  Q |---EXPIRED
| PT ET |
+-----+
END_FUNCTION_BLOCK

PROGRAM
+-----+          (* External interface *)
|  EXAMPLE_C  |
BOOL---|GO      DONE|---BOOL
+-----+

VAR_GLOBAL X_TMR : TON ; END_VAR

          I_BLK          (* Program body *)
+-----+
|  INSIDE_C  |
GO-----|TMR_GO EXPIRED|---DONE
+-----+
END_PROGRAM

```

IEC 2483/02

NOTE The PROGRAM declaration mechanism is defined in 2.5.3.

**Figure 11 c) - Graphical use of a function block name as an external variable
(table 33, feature 7b)**

<p>12a)</p>	<pre> +-----+ ACCUM INT--- A-----A ---INT INT--- X +-----+ +-----+ A--- + ---A X--- +-----+ </pre>	<pre> FUNCTION_BLOCK ACCUM VAR_IN_OUT A : INT ; END_VAR VAR_INPUT X : INT ; END_VAR A := A+X ; END_FUNCTION_BLOCK </pre>
<p>12b)</p>	<pre> ACC1 +-----+ ACCUM ACC----- A-----A ---ACC +-----+ X1--- * --- X X2--- +-----+ +-----+ </pre>	<p>A declaration such as</p> <pre> VAR ACC : INT ; X1 : INT ; X2 : INT ; END_VAR is assumed: the effect of execution is ACC := ACC+X1*X2 ; </pre>
<p>12c)</p>	<pre> ACC1 ACC2 +-----+ +-----+ ACCUM ACCUM ACC----- A-----A ---ACC A-----A ---ACC +-----+ +-----+ X1--- * --- X X3--- * --- X X2--- +-----+ X4--- +-----+ +-----+ +-----+ </pre>	<p>Declarations as in 12b) are assumed for ACC, X1, X2, X3, and X4.; the effect of execution is</p> <pre> ACC := ACC+X1*X2+X3*X4 ; </pre>
<p>12d)</p>	<pre> ACC1 +-----+ ACCUM X3----- A-----A ---X4 +-----+ X1--- * --- X X2--- +-----+ +-----+ </pre>	<p>A declaration such as</p> <pre> VAR X1 : INT ; X2 : INT ; ...X3 : INT ; ... X4 : INT ; END_VAR is assumed: the effect of execution is X3 := X3+X1*X2 ; X4 := X3 ; </pre>
<p>12e)</p>	<pre> ACC1 +-----+ ACCUM X1--- * --- X X2--- +-----+ +-----+ X3----- X +-----+ </pre>	<p>ILLEGAL USAGE!!! Connection to in-out variable A is not a variable or function block name (see preceding text)</p>

IEC 2484/02

Figure 12 - Declaration and usage of in-out variables in function blocks
a) Graphical and textual declarations
b), c), d) Legal usage, e) Illegal usage

2.5.2.3 Standard function blocks

Definitions of function blocks common to all programmable controller programming languages are given in this subclause.

Where graphical declarations of standard function blocks are shown in this subclause, equivalent textual declarations, as specified in 2.5.2.2, can also be written, as for example in table 35.

Standard function blocks may be *overloaded* and may have *extensible* inputs and outputs. The definitions of such function block *types* shall describe any constraints on the number and data types of such inputs and outputs. The use of such capabilities in non-standard function blocks is beyond the scope of this Standard.

2.5.2.3.1 Bistable elements

The graphical form and *function block body* of standard bistable elements are shown in table 34. The notation for these elements is chosen to be as consistent as possible with symbols 12-09-01 and 12-09-02 of IEC 60617-12.

Table 34 - Standard bistable function blocks ^a

No.	Graphical form	Function block body
1	Bistable function block (set dominant)	
	<pre> +-----+ SR BOOL--- S1 Q1 ---BOOL R +-----+</pre>	<pre> +-----+ S1----- >=1 ---Q1 +----+ R-----O & --- Q1----- +----+ +-----+</pre>
2	Bistable function block (reset dominant)	
	<pre> +-----+ RS BOOL--- S Q1 ---BOOL R1 +-----+</pre>	<pre> +-----+ R1-----O & ---Q1 +-----+ S----- >=1 --- Q1----- +-----+ +-----+</pre>
NOTE The function block body is specified in the Function Block Diagram (FBD) language defined in 4.3.		
^a The initial state of the output variable Q ₁ shall be the normal default value of zero for Boolean variables.		

2.5.2.3.2 Edge detection

The graphic representation of standard rising- and falling-edge detecting function blocks shall be as shown in table 35. The behaviors of these blocks shall be equivalent to the definitions given in this table. This behavior corresponds to the following rules:

- 1) The Q output of an R_TRIG function block shall stand at the BOOL#1 value from one execution of the function block to the next, following the 0 to 1 transition of the CLK input, and shall return to 0 at the next execution.
- 2) The Q output of an F_TRIG function block shall stand at the BOOL#1 value from one execution of the function block to the next, following the 1 to 0 transition of the CLK input, and shall return to 0 at the next execution.

Table 35 - Standard edge detection function blocks

No.	Graphical form	Definition (ST language - see 3.3)
1	<p>Rising edge detector</p> <pre> +-----+ R_TRIG BOOL--- CLK Q ---BOOL +-----+</pre>	<pre> FUNCTION_BLOCK R_TRIG VAR_INPUT CLK: BOOL; END_VAR VAR_OUTPUT Q: BOOL; END_VAR VAR M: BOOL; END_VAR Q := CLK AND NOT M; M := CLK; END_FUNCTION_BLOCK</pre>
	<pre> +-----+ F_TRIG BOOL--- CLK Q ---BOOL +-----+</pre>	<pre> FUNCTION_BLOCK F_TRIG VAR_INPUT CLK: BOOL; END_VAR VAR_OUTPUT Q: BOOL; END_VAR VAR M: BOOL; END_VAR Q := NOT CLK AND NOT M; M := NOT CLK; END_FUNCTION_BLOCK</pre>
<p>NOTE When the CLK input of an instance of the R_TRIG type is connected to a value of BOOL#1, its Q output will stand at BOOL#1 after its first execution following a “cold restart” as described in 2.4.2. The Q output will stand at BOOL#0 following all subsequent executions. The same applies to an F_TRIG instance whose CLK input is disconnected or is connected to a value of FALSE.</p>		

2.5.2.3.3 Counters

The graphic representations of standard counter function blocks, with the types of the associated inputs and outputs, shall be as shown in table 36. The operation of these function blocks shall be as specified in the corresponding function block bodies.

http://www.china-gauges.com/

Table 36 - Standard counter function blocks

No.	Graphical form	Function block body (ST language - see 3.3)
Up-counter		
1a	<pre> +-----+ CTU BOOL--->CU Q ---BOOL BOOL--- R INT--- PV CV ---INT +-----+</pre>	<pre> IF R THEN CV := PV ; ELSIF CD AND (CV < PVmax) THEN CV := CV+1; END_IF ; Q := (CV >= PV) ;</pre>
1b	<pre> +-----+ CTU_DINT BOOL--->CU Q ---BOOL BOOL--- R DINT--- PV CV ---DINT +-----+</pre>	Same as 1a
1c	<pre> +-----+ CTU_LINT BOOL--->CU Q ---BOOL BOOL--- R LINT--- PV CV ---LINT +-----+</pre>	Same as 1a
1d	<pre> +-----+ CTU_UDINT BOOL--->CU Q ---BOOL BOOL--- R UDINT--- PV CV ---UDINT +-----+</pre>	Same as 1a
1e	<pre> +-----+ CTU_ULINT BOOL--->CU Q ---BOOL BOOL--- R ULINT--- PV CV ---ULINT +-----+</pre>	Same as 1a
Down-counter		
2a	<pre> +-----+ CTD BOOL--->CD Q ---BOOL BOOL--- LD INT--- PV CV ---INT +-----+</pre>	<pre> IF LD THEN CV := PV ; ELSIF CD AND (CV > PVmin) THEN CV := CV-1; END_IF ; Q := (CV <= 0) ;</pre>
2b	<pre> +-----+ CTD_DINT BOOL--->CD Q ---BOOL BOOL--- LD DINT--- PV CV ---DINT +-----+</pre>	Same as 2a

http://www.china-gauges.com/

Table 36 - Standard counter function blocks

No.	Graphical form	Function block body (ST language - see 3.3)
2c	<pre> +-----+ CTD_LINT BOOL--->CD Q ---BOOL BOOL--- LD LINT--- PV CV ---LINT +-----+ </pre>	Same as 2a
2d	<pre> +-----+ CTD_UDINT BOOL--->CD Q ---BOOL BOOL--- LD UDINT--- PV CV ---UDINT +-----+ </pre>	Same as 2a
2e	<pre> +-----+ CTD_ULINT BOOL--->CD Q ---BOOL BOOL--- LD ULINT--- PV CV ---ULINT +-----+ </pre>	Same as 2a
Up-down counter		
3a	<pre> +-----+ CTUD BOOL--->CU QU ---BOOL BOOL--->CD QD ---BOOL BOOL--- R BOOL--- LD INT--- PV CV ---INT +-----+ </pre>	<pre> IF R THEN CV := 0 ; ELSIF LD THEN CV := PV ; ELSE IF NOT (CU AND CD) THEN IF CU AND (CV < PVmax) THEN CV := CV+1; ELSIF CD AND (CV > PVmin) THEN CV := CV-1; END_IF; END_IF; END_IF ; QU := (CV >= PV) ; QD := (CV <= 0) ; </pre>
3b	<pre> +-----+ CTUD_DINT BOOL--->CU QU ---BOOL BOOL--->CD QD ---BOOL BOOL--- R BOOL--- LD DINT--- PV CV ---DINT +-----+ </pre>	Same as 3a
3c	<pre> +-----+ CTUD_LINT BOOL--->CU QU ---BOOL BOOL--->CD QD ---BOOL BOOL--- R BOOL--- LD LINT--- PV CV ---LINT +-----+ </pre>	Same as 3a

<http://www.china-gauges.com/>

Table 36 - Standard counter function blocks

No.	Graphical form	Function block body (ST language - see 3.3)
3d	<pre> +-----+ CTUD_ULINT BOOL--->CU QU ---BOOL BOOL--->CD QD ---BOOL BOOL--- R BOOL--- LD ULINT--- PV CV ---ULINT +-----+ </pre>	Same as 3a
NOTE	The numerical values of the limit variables PV _{min} and PV _{max} are implementation-dependent .	

2.5.2.3.4 Timers

The graphic form for standard timer function blocks shall be as shown in table 37. The operation of these function blocks shall be as defined in the timing diagrams given in table 38.

Table 37 - Standard timer function blocks

No.	Description	Graphical form
1	*** is: TP (Pulse)	<pre> +-----+ *** BOOL--- IN Q ---BOOL TIME--- PT ET ---TIME +-----+ </pre>
2a	TON (On-delay)	
2b ^a	T---0 (On-delay)	
3a	TOF (Off-delay)	
3b ^a	0---T (Off-delay)	
NOTE	The effect of a change in the value of the PT input during the timing operation, e.g., the setting of PT to t#0s to reset the operation of a TP instance, is an implementation-dependent parameter .	
	^a In textual languages, features 2b and 3b shall not be used.	

<http://www.china-gauges.com/>

Table 38 - Standard timer function blocks - timing diagrams

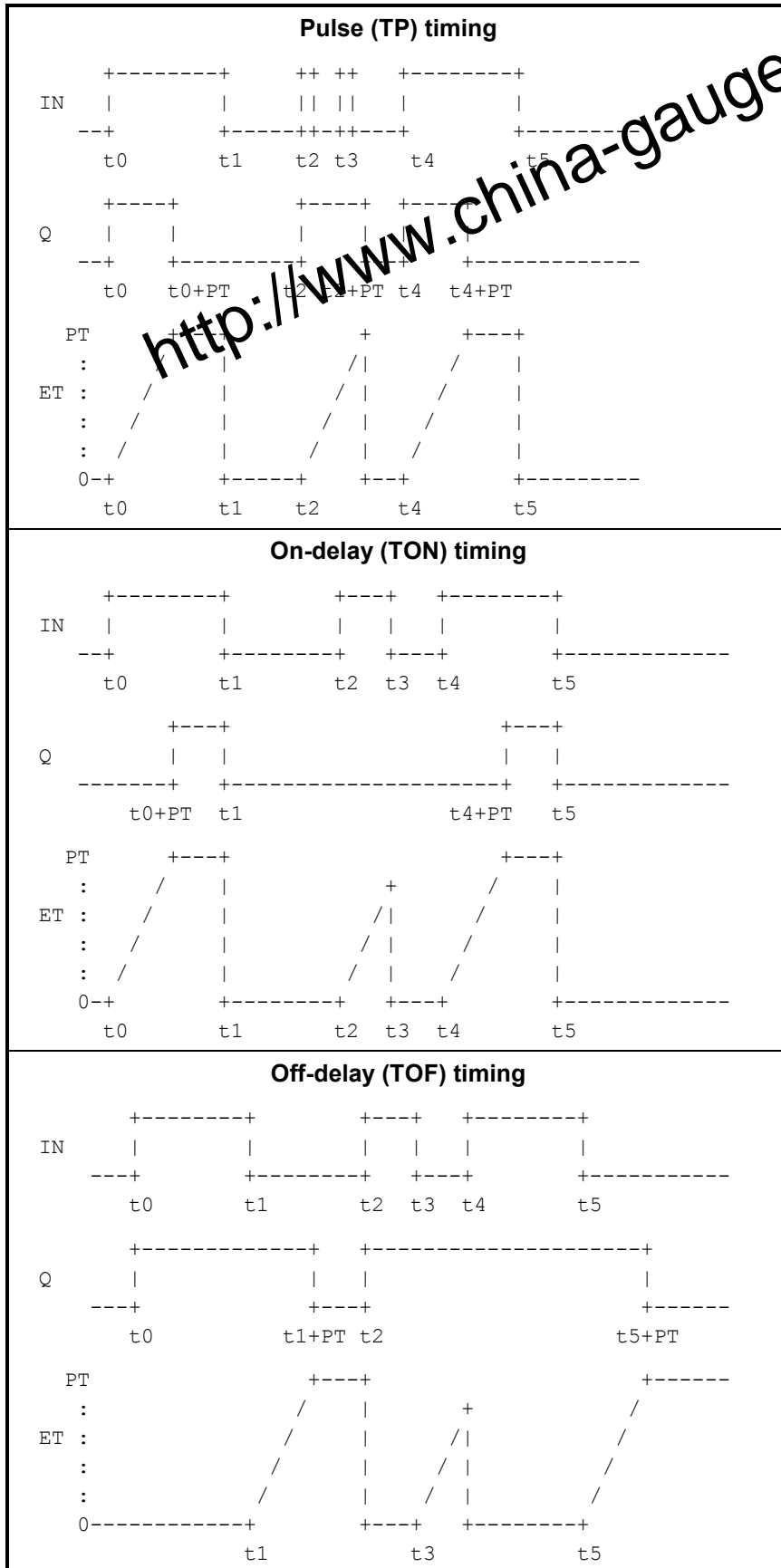

<http://www.china-gauges.com/>

2.5.2.3.5 Communication function blocks

Standard communication function blocks for programmable controllers are defined in IEC 61131-5. These function blocks provide programmable communications functionality such as device verification, polled data acquisition, programmed data acquisition, parametric control, interlocked control, programmed alarm reporting, and connection management and protection.

2.5.3 Programs

A *program* is defined in IEC 61131-1 as a “logical assembly of all the programming language elements and constructs necessary for the intended signal processing required for the control of a machine or process by a programmable controller system”

Subclause 1.4.1 of this part describes the place of programs in the overall software model of a programmable controller; subclause 1.4.2 describes the means available for inter- and intra-program communication; and subclause 1.4.3 describes the overall process of program development.

The declaration and usage of *programs* is identical to that of *function blocks* as defined in 2.5.2.1 and 2.5.2.2, with the additional features shown in table 39 and the following differences:

- 1) The delimiting keywords for program declarations shall be PROGRAM . . . END_PROGRAM.
- 2) A program can contain a VAR_ACCESS . . . END_VAR construction, which provides a means of specifying named variables which can be accessed by some of the communication services specified in IEC 61131-5. An *access path* associates each such variable with an input, output or internal variable of the program. The format and usage of this declaration shall be as described in 2.7.1 and in IEC 61131-5.
- 3) *Programs* can only be instantiated within *resources*, as defined in 2.7.1, while *function blocks* can only be instantiated within *programs* or other *function blocks*.
- 4) A program can contain location assignments as described in 2.4.3.1 and 2.4.3.2 in the declarations of its global and internal variables. Location assignments with not fully specified direct representation as described in 2.4.1.1 and 2.4.3.1 can only be used in the declaration of internal variables of a program.

The declaration and use of programs are illustrated in figure 19, and in examples F.7 and F.8.

Limitations on the size of programs in a particular *resource* are **implementation-dependent** parameters.

Table 39 - Program declaration features

No.	DESCRIPTION
1 to 9b	Same as features 1 to 9b, respectively, of table 33
10	Formal input and output variables
11 to 14	Same as features 1 to 4, respectively, of table 17
15 to 18	Same as features 1 to 4, respectively, of table 18
19	Use of directly represented variables (subclause 2.4.1.1)
20	VAR_GLOBAL . . . END_VAR declaration within a PROGRAM (see 2.4.3 and 2.7.1)
21	VAR_ACCESS . . . END_VAR declaration within a PROGRAM
22a	VAR_EXTERNAL declarations within PROGRAM type declarations
22b	VAR_EXTERNAL CONSTANT declarations within PROGRAM type declarations
23	VAR_GLOBAL CONSTANT declarations within PROGRAM type declarations
24	VAR_TEMP declarations (see 2.4.3) within PROGRAM type declarations

http://www.china-gauges.com/

2.6 Sequential Function Chart (SFC) elements

2.6.1 General

This subclause defines *sequential function chart* (SFC) elements for use in structuring the internal organization of a programmable controller program organization unit, written in one of the languages defined in this standard, for the purpose of performing *sequential control* functions. The definitions in this subclause are derived from IEC 60848, with the changes necessary to convert the representations from a *documentation standard* to a set of *execution control elements* for a programmable controller program organization unit.

The SFC elements provide a means of partitioning a programmable controller program organization unit into a set of *steps* and transitions interconnected by *directed links*. Associated with each step is a set of *actions*, and with each transition is associated a *transition condition*.

Since SFC elements require storage of state information, the only program organization units which can be structured using these elements are *function blocks* and *programs*.

If any part of a program organization unit is partitioned into SFC elements, the entire program organization unit shall be so partitioned. If no SFC partitioning is given for a program organization unit, the entire program organization unit shall be considered to be a single *action* which executes under the control of the invoking entity.

2.6.2 Steps

A *step* represents a situation in which the behavior of a program organization unit with respect to its inputs and outputs follows a set of rules defined by the associated *actions* of the step. A step is either *active* or *inactive*. At any given moment, the state of the program organization unit is defined by the set of active steps and the values of its internal and output variables.

As shown in table 40, a step shall be represented graphically by a block containing a *step name* in the form of an identifier as defined in 2.1.2, or textually by a STEP...END_STEP construction. The directed link(s) into the step can be represented graphically by a vertical line attached to the top of the step. The directed link(s) out of the step can be represented by a vertical line attached to the bottom of the step. Alternatively, the directed links can be represented textually by the TRANSITION...END_TRANSITION construction defined in 2.6.3.

The *step flag* (active or inactive state of a step) can be represented by the logic value of a Boolean structure element `***.X`, where `***` is the step name, as shown in table 40. This Boolean variable has the value 1 when the corresponding step is active, and 0 when it is inactive. The state of this variable is available for graphical connection at the right side of the step as shown in table 40.

Similarly, the elapsed time, `***.T`, since initiation of a step can be represented by a structure element of type `TIME`, as shown in table 40. When a step is deactivated, the value of the step elapsed time shall remain at the value it had when the step was deactivated. When a step is activated, the value of the step elapsed time shall be reset to `t#0s`.

The *scope* of step names, step flags, and step times shall be *local* to the program organization unit in which the steps appear.

The initial state of the program organization unit is represented by the initial values of its internal and output variables, and by its set of *initial steps*, i.e., the steps which are initially active. Each SFC *network*, or its textual equivalent, shall have exactly one initial step.

An initial step can be drawn graphically with double lines for the borders. When the character set defined in 2.1.1 is used for drawing, the initial step shall be drawn as shown in table 40.

http://www.china-gauges.com/

For system initialization as defined in 2.4.2, the default initial elapsed time for steps is t#0s, and the default initial state is BOOL#0 for ordinary steps and BOOL#1 for initial steps. However, when an instance of a function block or a program is declared to be retentive (for instance, as in feature 3 of table 33), the states and (if supported) elapsed times of all steps contained in the program or function block shall be treated as retentive for system initialization as defined in 2.4.2.

The maximum number of steps per SFC and the precision of step elapsed time are **implementation-dependent** parameters.

It shall be an **error** if:

- 1) an SFC network does not contain exactly one initial step.
- 2) a user program attempts to assign a value directly to the step state or the step time.

Table 40 - Step features

No.	REPRESENTATION	DESCRIPTION
1	<pre> +-----+ *** +-----+ </pre>	Step - graphical form with directed links "***" = step name
	<pre> +=====+ *** +=====+ </pre>	Initial step - graphical form with directed links "***" = name of initial step
2	<pre> STEP *** : (* Step body *) END_STEP </pre>	Step - textual form without directed links (see 2.6.3) "***" = step name
	<pre> INITIAL_STEP *** : (* Step body *) END_STEP </pre>	Initial step - textual form without directed links (see 2.6.3) "***" = name of initial step
3a ^a	<pre> ***.X </pre>	Step flag - general form "***" = step name ***.X = BOOL#1 when *** is active, BOOL#0 otherwise
3b ^a	<pre> +-----+ *** ---- +-----+ </pre>	Step flag - direct connection of Boolean variable ***.X to right side of step "***"
4 ^a	<pre> ***.T </pre>	Step elapsed time - general form "***" = step name ***.T = a variable of type TIME (See 2.6.2)
NOTE The upper directed link to an initial step is not present if it has no predecessors.		
<p>^a When feature 3a, 3b, or 4 is supported, it shall be an error if the user program attempts to modify the associated variable. For example, if S4 is a step name, then the following statements would be errors in the ST language defined in 3.3:</p> <pre> S4.X := 1 ; (* ERROR *) S4.T := t#100ms ; (* ERROR *) </pre>		

2.6.3 Transitions

A *transition* represents the condition whereby control passes from one or more steps preceding the transition to one or more successor steps along the corresponding directed link. The transition shall be represented by a horizontal line across the vertical directed link.

The direction of evolution following the directed links shall be from the bottom of the predecessor step(s) to the top of the successor step(s).

Each transition shall have an associated *transition condition* which is the result of the evaluation of a single Boolean expression. A transition condition which is always true shall be represented by the symbol 1 or the keyword `TRUE`.

A transition condition can be associated with a transition by one of the following means, as shown in table 41:

- 1) By placing the appropriate Boolean expression in the ST language defined in 3.3 physically or logically adjacent to the vertical directed link.
- 2) By a ladder diagram network in the LD language defined in 4.2, physically or logically adjacent to the vertical directed link.
- 3) By a network in the FBD language defined in 4.3, physically or logically adjacent to the vertical directed link.
- 4) By a LD or FBD network whose output intersects the vertical directed link via a *connector* as defined in 4.1.1.
- 5) By a `TRANSITION...END_TRANSITION` construct using the ST language. This shall consist of:
 - the keywords `TRANSITION FROM` followed by the step name of the predecessor step (or, if there is more than one predecessor, by a parenthesized list of predecessor steps);
 - the keyword `TO` followed by the step name of the successor step (or, if there is more than one successor, by a parenthesized list of successor steps);
 - the assignment operator (`:=`), followed by a Boolean expression in the ST language, specifying the transition condition;
 - the terminating keyword `END_TRANSITION`.
- 6) By a `TRANSITION...END_TRANSITION` construct using the IL language defined in 3.2. This shall consist of:
 - the keywords `TRANSITION FROM` followed by the step name of the predecessor step (or, if there is more than one predecessor, by a parenthesized list of predecessor steps), followed by a colon (`:`);
 - the keyword `TO` followed by the step name of the successor step (or, if there is more than one successor, by a parenthesized list of successor steps);
 - beginning on a separate line, a list of instructions in the IL language, the result of whose evaluation determines the transition condition;
 - the terminating keyword `END_TRANSITION` on a separate line.
- 7) By the use of a *transition name* in the form of an identifier to the right of the directed link. This identifier shall refer to a `TRANSITION...END_TRANSITION` construction defining one of the following entities, whose evaluation shall result in the assignment of a Boolean value to the variable denoted by the transition name:
 - a network in the LD or FBD language;
 - a list of instructions in the IL language;
 - an assignment of a Boolean expression in the ST language.

<http://www.china-gauges.com/>

The *scope* of a transition name shall be *local* to the program organization unit in which the transition is located.

It shall be an **error** in the sense of 1.5.1 if any “side effect” (for instance, the assignment of a value to a variable other than the transition name) occurs during the evaluation of a transition condition.

The maximum number of transitions per SFC and per step are **implementation-dependent** parameters.

Table 41 - Transitions and transition conditions

No.	Example	Description
1 ^a	<pre> +-----+ STEP7 +-----+ + %IX2.4 & %IX2.3 +-----+ STEP8 +-----+ </pre>	<p>Predecessor step</p> <p>Transition condition physically or logically adjacent to the transition using ST language (see 3.3)</p> <p>Successor step</p>
2 ^a	<pre> +-----+ STEP7 +-----+ %IX2.4 %IX2.3 +---+ +-----+ +-----+ +-----+ STEP8 +-----+ </pre>	<p>Predecessor step</p> <p>Transition condition physically or logically adjacent to the transition using LD language (see 4.2)</p> <p>Successor step</p>
3 ^a	<pre> +-----+ STEP7 +-----+ & +-----+ +-----+ %IX2.4--- -----+ %IX2.3--- +-----+ +-----+ STEP8 +-----+ </pre>	<p>Predecessor step</p> <p>Transition condition physically or logically adjacent to the transition using FBD language (see 4.3)</p> <p>Successor step</p>

Licensed Copy: Institute Of Technology Tallaght, Institute of Technology, Wed Jun 20 03:54:45 GMT+00:00 2007, Uncontrolled Copy, (c) BSI

<http://www.china-gauges.com/>

Table 41 - Transitions and transition conditions

<p>4^a</p>	<pre> +-----+ STEP7 +-----+ >TRANX>-----+ +-----+ STEP8 +-----+ </pre>	<p>Use of connector: predecessor step transition connector successor step</p>
<p>4a</p>	<pre> %IX2.4 %IX2.3 +--- --->TRANX> </pre>	<p>Transition condition: Using LD language (see 4.2)</p>
<p>4b</p>	<pre> +-----+ & %IX2.4--- --->TRANX> %IX2.3--- +-----+ </pre>	<p>Using FBD language (see 4.3)</p>
<p>5^b</p>	<pre> STEP STEP7: END_STEP TRANSITION FROM STEP7 TO STEP8 := %IX2.4 & %IX2.3 ; END_TRANSITION STEP STEP8: END_STEP </pre>	<p>Textual equivalent of feature 1 using ST language (see 3.3)</p>
<p>6^b</p>	<pre> STEP STEP7: END_STEP TRANSITION FROM STEP7 TO STEP 8: LD %IX2.4 AND %IX2.3 END_TRANSITION STEP STEP8: END_STEP </pre>	<p>Textual equivalent of feature 1 using IL language (see 3.2)</p>
<p>7^a</p>	<pre> +-----+ STEP7 +-----+ +-----+ STEP8 +-----+ </pre>	<p>Use of transition name: predecessor step transition name successor step</p>
<p>7a</p>	<pre> TRANSITION TRAN78 FROM STEP7 TO STEP8: %IX2.4 %IX2.3 TRAN78 +--- ----- ----- ()-----+ END_TRANSITION </pre>	<p>Transition condition using LD language (see 4.2)</p>

<http://www.china-gauges.com/>

Table 41 - Transitions and transition conditions

7b	<pre> TRANSITION TRAN78 FROM STEP7 TO STEP8: +-----+ & %IX2.4--- ---TRAN78 %IX2.3--- +-----+ END_TRANSITION </pre>	Transition condition using FBD language (see 4.3)
7c	<pre> TRANSITION TRAN78 FROM STEP7 TO STEP8: LD %IX2.4 AND %IX2.3 END_TRANSITION </pre>	Transition condition using IL language (see 3.2)
7d	<pre> TRANSITION TRAN78 FROM STEP7 TO STEP8 := %IX2.4 & %IX2.3 ; END_TRANSITION </pre>	Transition condition using ST language (see 3.3)
<p>^a If feature 1 of table 40 is supported, then one or more of features 1, 2, 3, 4, or 7 of this table shall be supported.</p> <p>^b If feature 2 of table 40 is supported, then feature 5 or 6 of this table, or both, shall be supported.</p>		

2.6.4 Actions

Zero or more *actions* shall be associated with each step. A step which has zero associated actions shall be considered as having a WAIT function, that is, waiting for a successor transition condition to become true.

An action can be a Boolean variable, a collection of *instructions* in the IL language defined in 3.2, a collection of *statements* in the ST language defined in 3.3, a collection of *rungs* in the LD language defined in 4.2, a collection of *networks* in the FBD language defined in 4.3, or a *sequential function chart* (SFC) organized as defined in 2.6.

Actions shall be declared via one or more of the mechanisms defined in 2.6.4.1, and shall be associated with steps via textual *step bodies* or graphical *action blocks*, as defined in 2.6.4.2. The details of action block representation are defined in 2.6.4.3. Control of actions shall be expressed by *action qualifiers* as defined in 2.6.4.4.

2.6.4.1 Declaration

A programmable controller implementation which supports SFC elements shall provide one or more of the mechanisms defined in table 42 for the declaration of actions. The *scope* of the declaration of an action shall be *local* to the program organization unit containing the declaration.

Table 42 - Declaration of actions ^{a,b}

No.	Feature	
1	Any Boolean variable declared in a VAR or VAR_OUTPUT block, or their graphical equivalents, can be an action.	
No.	Example	Feature
2i	<pre> +-----+ ACTION_4 +-----+ %IX1 %MX3 S8.X %Q17 +---+ -----+ -----+ -----+ -----+ -----+ +-----+ +-----+ EN ENO C-- LT -----+ (S)----+ D-- +-----+ +-----+ </pre>	Graphical declaration in LD language (see 4.2)
2s	<pre> +-----+ OPEN_VALVE_1 +-----+ ... +-----+ VALVE_1_READY +-----+ + STEP8.X +-----+ +-----+ +-----+ VALVE_1_OPENING -- N VALVE_1_FWD +-----+ +-----+ +-----+ ... +-----+ </pre>	Inclusion of SFC elements in action
2f	<pre> +-----+ ACTION_4 +-----+ +-----+ %IX1-- & %MX3-- ---%QX17 S8.X----- +-----+ FF28 +-----+ SR +-----+ Q1 --%MX10 C-- LT -- S1 D-- +-----+ +-----+ +-----+ </pre>	Graphical declaration in FBD language (see 4.3)

<http://www.china-gauges.com/>

Table 42 - Declaration of actions ^{a,b}

No.	Feature	
3s	<pre> ACTION ACTION_4: %QX17 := %IX1 & %MX3 & S8.X ; FF28(S1 := (C<D)); %MX10 := FF28.Q; END_ACTION </pre>	
3i	<pre> ACTION ACTION_4: LD S8.X AND %IX1 AND %MX3 ST %QX17 LD C LT D S1 FF28 LD FF28.Q ST %MX10 END_ACTION </pre>	
<p>NOTE The step flag <code>S8.X</code> is used in these examples to obtain the desired result such that, when <code>S8</code> is deactivated, <code>%QX17 := 0</code>.</p>		
<p>^a If feature 1 of table 40 is supported, then one or more of the features in this table, or feature 4 of table 43, shall be supported.</p> <p>^b If feature 2 of table 40 is supported, then one or more of features 1,3 s, or 3i of this table shall be supported.</p>		

2.6.4.2 Association with steps

A programmable controller implementation which supports SFC elements shall provide one or more of the mechanisms defined in table 43 for the association of actions with steps. The maximum number of action blocks per step is an **implementation-dependent** parameter.

<http://www.china-gauges.com/>

Table 43 - Step/action association

No.	Example	Feature
1	<pre> +-----+ +-----+-----+-----+ S8 -- L ACTION_1 DN1 +-----+ t#10s +-----+-----+-----+ + DN1 </pre>	Action block physically or logically adjacent to the step (see 2.6.4.3)
2	<pre> +-----+ +-----+-----+-----+ S8 -- L ACTION_1 DN1 +-----+ t#10s +-----+-----+-----+ +DN1 P ACTION_2 +-----+-----+-----+ N ACTION_3 +-----+-----+-----+ </pre>	Concatenated action blocks physically or logically adjacent to the step
3	<pre> STEP S8: ACTION_1 (L,t#10s, DN1) ; ACTION_2 (P) ; ACTION_3 (N) ; END_STEP </pre>	Textual step body
4 ^a	<pre> +-----+-----+-----+-----+ ---- N ACTION_4 ---- +-----+-----+-----+-----+ %QX17 := %IX1 & %MX3 & S8.X ; FF28 (S1 := (C<D)); %MX10 := FF28.Q; +-----+-----+-----+-----+ </pre>	Action block "d" field (see 2.6.4.3)
<p>^a When feature 4 is used, the corresponding action name cannot be used in any other action block.</p>		

2.6.4.3 Action blocks

As shown in table 44, an *action block* is a graphical element for the combination of a Boolean variable with one of the *action qualifiers* specified in subclause 2.6.4.4 to produce an enabling condition, according to the rules given in subclause 2.6.4.5, for an associated action.

The action block provides a means of optionally specifying Boolean “indicator” variables, indicated by the “c” field in table 44, which can be set by the specified action to indicate its completion, timeout, error conditions, etc. If the “c” field is not present, and the “b” field specifies that the action shall be a Boolean variable, then this variable shall be interpreted as the “c” variable when required. If the (c) field is not defined, and the (b) field does not specify a Boolean variable, then the value of the “indicator” variable is considered to be always FALSE.

When action blocks are concatenated graphically as illustrated in table 43, such concatenations can have multiple indicator variables, but shall have only a single common Boolean input variable, which shall act simultaneously upon all the concatenated blocks.

As well as being associated with a step, an action block can be used as a graphical element in the LD or FBD languages specified in clause 4. In this case, signal or power flow through an action block shall follow the rules specified in 4.1.1.

Table 44 - Action block features

No.	Feature	Graphical form
1 ^a	"a" : Qualifier as per 2.6.4.4	
2	"b" : Action name	+-----+-----+-----+
3 ^b	"c" : Boolean "indicator" variables	--- "a" "b" "c" ---
4	"d" : Action using:	+-----+-----+-----+
5	- IL language (3.2)	"d"
6	- ST language (3.3)	"d"
7	- LD language (4.2)	+-----+-----+-----+
7	- FBD language (4.3)	
No.	Feature/Example	
8	Use of action blocks in ladder diagrams (see 4.2):	
	<pre> S8.X %IX7.5 +---+-----+-----+ OK1 +--- ----- ----- N ACT1 DN1 ---()---+ +---+-----+-----+ </pre>	
9	Use of action blocks in function block diagrams (see 4.3):	
	<pre> +---+ +---+-----+-----+ S8.X--- & ----- N ACT1 DN1 ---OK1 %IX7.5--- +---+-----+-----+ +---+ </pre>	
^a Field "a" can be omitted when the qualifier is "N".		
^b Field "c" can be omitted when no indicator variable is used.		

2.6.4.4 Action qualifiers

Associated with each step/action association defined in 2.6.4.2, or each occurrence of an action block as defined in 2.6.4.3, shall be an *action qualifier*. The value of this qualifier shall be one of the values listed in table 45. In addition, the qualifiers L, D, SD, DS, and SL shall have an associated duration of type TIME.

NOTE IEC 60848 gives informal definitions and examples of the use of these qualifiers. This standard formalizes these definitions, redefining the S qualifier and introducing the R qualifier. The control of actions using these qualifiers is defined in the following subclause, and additional examples of their use are given in annex F.

Licensed Copy: Institute Of Technology Tallaght, Institute of Technology, Wed Jun 20 03:54:45 GMT+00:00 2007, Uncontrolled Copy, (c) BSI

Table 45 - Action qualifiers

No.	Qualifier	Explanation
1	None	Non-stored (null qualifier)
2	N	Non-stored
3	R	overriding Reset
4	S	Set (Stored)
5	L	time Limited
6	D	time Delayed
7	P	Pulse
8	SD	Stored and time Delayed
9	DS	Delayed and Stored
10	SL	Stored and time Limited
11	P1	Pulse (rising edge)
12	P0	Pulse (falling edge)

2.6.4.5 Action control

The control of actions shall be functionally equivalent to the application of the following rules:

- 1) Associated with each action shall be the functional equivalent of an instance of the `ACTION_CONTROL` function block defined in figures 14 and 15. If the action is declared as a Boolean variable, as defined in 2.6.4.1, the `Q` output of this block shall be the state of this Boolean variable. If the action is declared as a collection of statements or networks, as defined in 2.6.4.1, then this collection shall be executed continually while the `A` (activation) output of the `ACTION_CONTROL` function block stands at `BOOL#1`. In this case, the state of the output `Q` (called the "action flag") can be accessed within the action by reading a read-only boolean variable which has the form of a reference to the `Q` output of a function block instance whose instance name is the same as the corresponding action name, for example, `ACTION1.Q`.

NOTE 1 The condition `Q=FALSE` will ordinarily be used by an action to determine that it is being executed for the final time during its current activation.

NOTE 2 The value of `Q` will always be `FALSE` during execution of actions invoked by `P0` and `P1` qualifiers.

NOTE 3 The value of `A` will be `TRUE` for only one execution of an action invoked by a `P1` or `P0` qualifier. For all other qualifiers, `A` will be true for one additional execution following the falling edge of `Q`.

NOTE 4 Access to the functional equivalent of the `Q` or `A` outputs of an `ACTION_CONTROL` function block from outside of the associated action is an **implementation-dependent** feature.

NOTE 5 The manufacturer may opt for a simpler implementation as shown in figure 15 b). In this case, if the action is declared as a collection of statements or networks, as defined in 2.6.4.1, then this collection shall be executed continually while the `Q` output of the `ACTION_CONTROL` function block stands at `BOOL#1`. In any case the manufacturer shall specify which of the features given in table 45 a) is supported.

<http://www.china-gauges.com/>

- 2) A Boolean input to the ACTION_CONTROL block for an action shall be said to have an *association* with a step as defined in 2.6.4.2, or with an action block as defined in 2.6.4.3, if the corresponding qualifier is equivalent to the input name (N, R, S, L, D, P, P0, P1, SD, DS, or SL). The association shall be said to be *active* if the associated step is active, or if the associated action block's input has the value BOOL#1. The *active associations* of an action are equivalent to the set of *active associations* of all inputs to its ACTION_CONTROL function block.

A Boolean input to an ACTION_CONTROL block shall have the value BOOL#1 if it has at least one active association, and the value BOOL#0 otherwise.

- 3) The value of the T input to an ACTION_CONTROL block shall be the value of the duration portion of a time-related qualifier (L, D, SD, DS, or SL) of an active association. If no such association exists, the value of the T input shall be #Ns.
- 4) It shall be an **error** in the sense of subclause 1.5.1 if one or more of the following conditions exist:
- a) More than one *active association* of an action has a time-related qualifier (L, D, SD, DS, or SL).
 - b) The SD input to an ACTION_CONTROL block has the BOOL#1 when the Q1 output of its SL_FF block has the value BOOL#1.
 - c) The SL input to an ACTION_CONTROL block has the value BOOL#1 when the Q1 output of its SD_FF block has the value BOOL#1.
- 5) It is not required that the ACTION_CONTROL block itself be implemented, but only that the control of actions be equivalent to the preceding rules. Only those portions of the action control appropriate to a particular action need be instantiated, as illustrated in figure 16. In particular, note that simple MOVE (: =) and Boolean OR functions suffice for control of Boolean variable actions if the latter's associations have only "N" qualifiers.

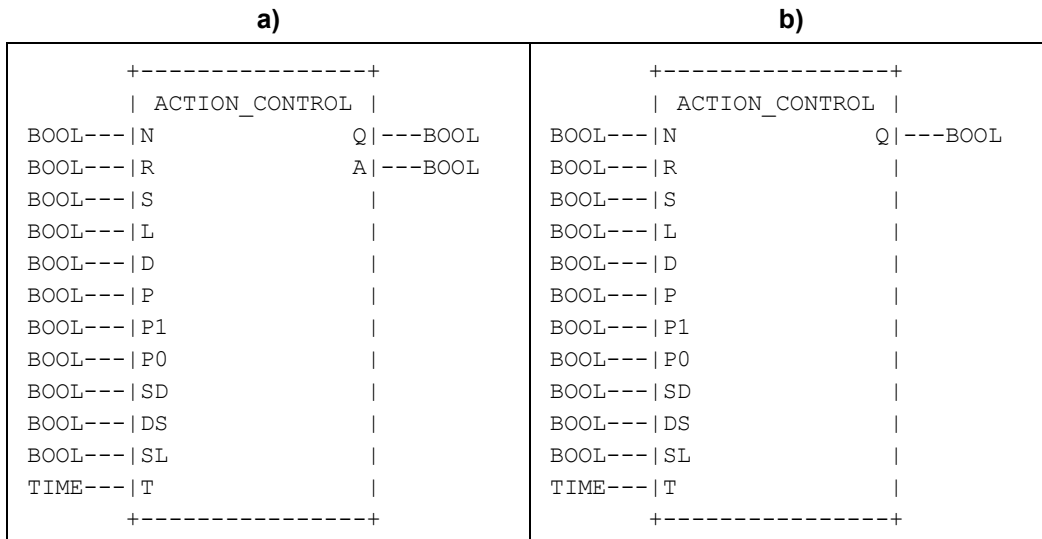

IEC 2485/02

Figure 14 - ACTION_CONTROL function block - External interface (Not visible to the user)
a) With "final scan" logic - see figure 15 a); b) Without "final scan" logic - see figure 15 b)

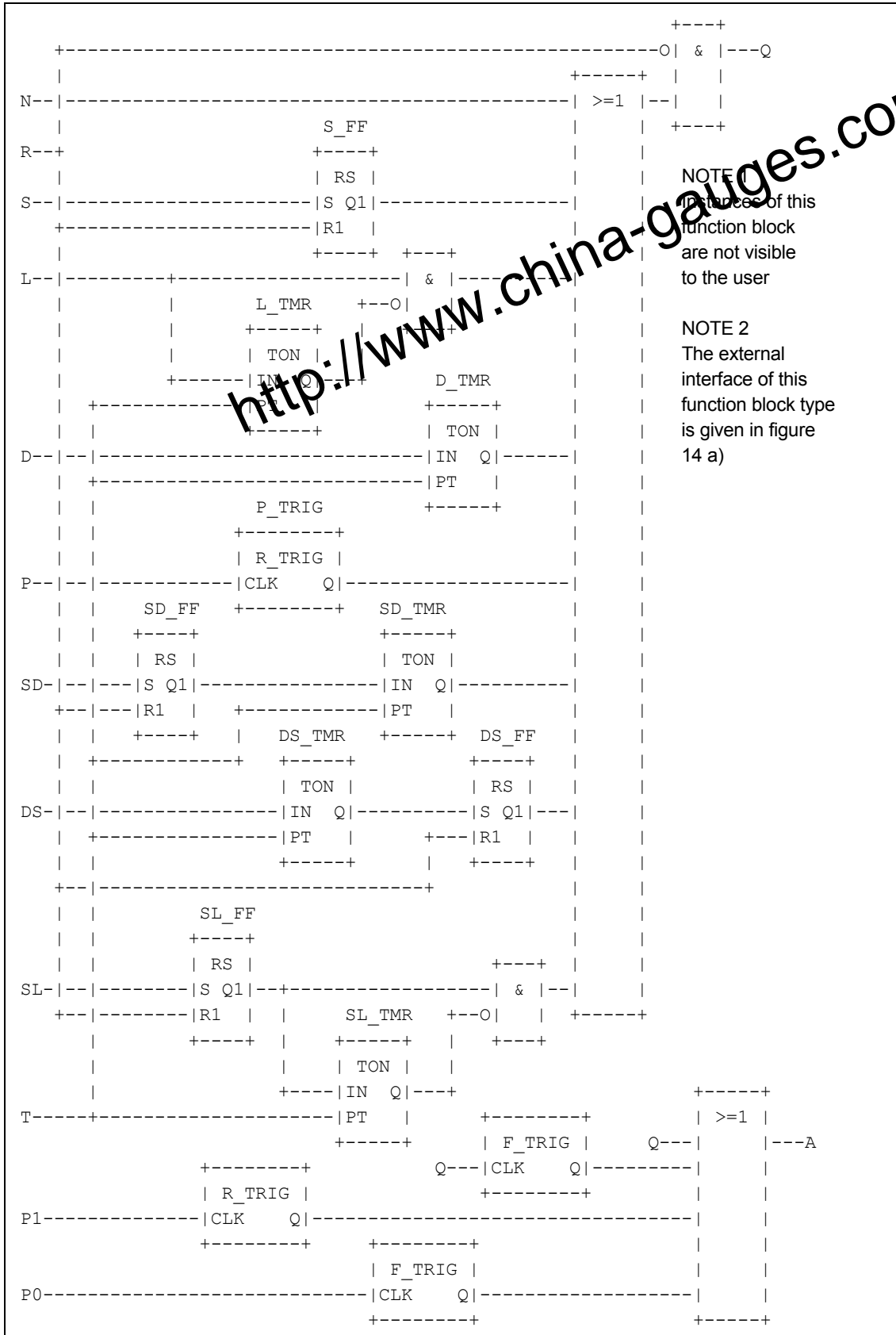
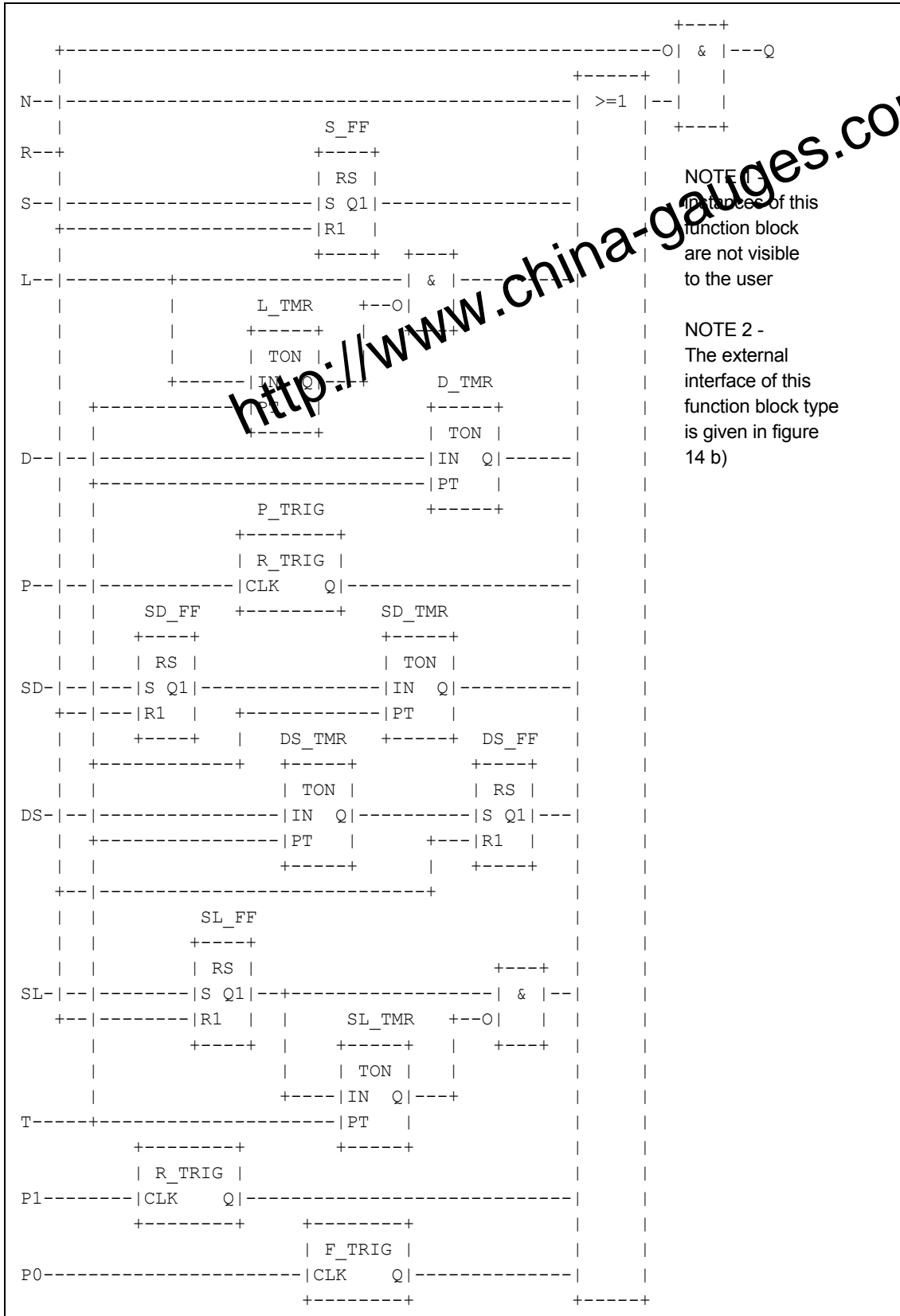

Figure 15 a) - ACTION_CONTROL function block body with "final scan" logic



IEC 2487/02

Figure 15 b) - ACTION_CONTROL function block body without "final scan" logic



<http://www.china-gauges.com/>

IEC 2488/02

NOTE The complete SFC network and its associated declarations are not shown in this example.

Figure 16 a) - Action control example - SFC representation

Table 45 a) - Action control features

No.	Description
1	per figures 14 a) and 15 a)
2	per figures 14 b) and 15 b)

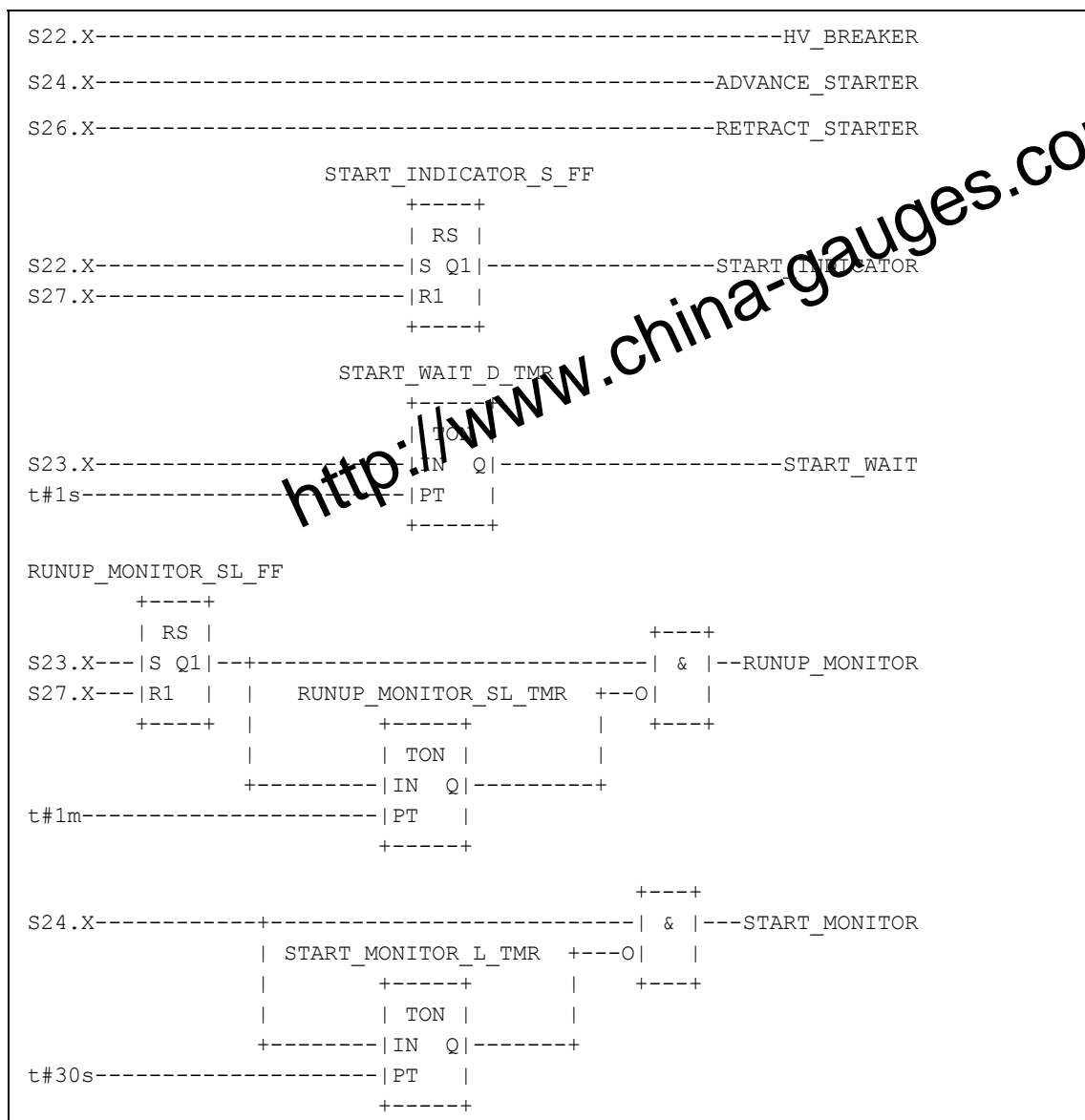

IEC 2489/02

Figure 16 b) - Action control example - functional equivalent

2.6.5 Rules of evolution

The *initial situation* of a SFC network is characterized by the *initial step* which is in the active state upon initialization of the program or function block containing the network.

Evolutions of the active states of steps shall take place along the *directed links* when caused by the *clearing* of one or more *transitions*.

A transition is *enabled* when all the preceding steps, connected to the corresponding transition symbol by directed links, are active. The clearing of a transition occurs when the transition is enabled and when the associated transition condition is true.

The clearing of a transition causes the *deactivation* (or "resetting") of all the immediately preceding steps connected to the corresponding transition symbol by directed links, followed by the *activation* of all the immediately following steps.

The alternation step/transition and transition/step shall always be maintained in SFC element connections, that is:

- Two steps shall never be directly linked; they shall always be separated by a transition.
- Two transitions shall never be directly linked; they shall always be separated by a step.

When the clearing of a transition leads to the activation of several steps at the same time, the sequences to which these steps belong are called *simultaneous sequences*. After their simultaneous activation, the evolution of each of these sequences becomes independent. In order to emphasize the special nature of such constructs, the divergence and convergence of simultaneous sequences shall be indicated by a double horizontal line.

It shall be an **error** if the possibility can arise that non-prioritized transitions in a selection divergence, as shown in feature 2a of table 46, are simultaneously true. The user may make provisions to avoid this error as shown in features 2b and 2c of table 46.

Table 46 defines the syntax and semantics of the allowed combinations of steps and transitions.

The clearing time of a transition may theoretically be considered as short as one may wish, but it can never be zero. In practice, the clearing time will be imposed by the programmable controller implementation. For the same reason, the duration of a step activity can never be considered to be zero.

Several transitions which can be cleared simultaneously shall be cleared simultaneously, within the timing constraints of the particular programmable controller implementation and the priority constraints defined in table 46.

Testing of the successor transition condition(s) of an active step shall not be performed until the effects of the step activation have propagated throughout the program organization unit in which the step is declared.

Figure 17 illustrates the application of these rules. In this figure, the active state of a step is indicated by the presence of an asterisk (*) in the corresponding block. This notation is used for illustration only, and is not a required language feature.

The application of the rules given in this subclause cannot prevent the formulation of “unsafe” SFCs, such as the one shown in figure 18 a), which may exhibit uncontrolled proliferation of tokens. Likewise, the application of these rules cannot prevent the formulation of “unreachable” SFCs, such as the one shown in figure 18 b), which may exhibit “locked up” behavior. The programmable controller system shall treat the existence of such conditions as **errors** as defined in 1.5.1.

The maximum allowed widths of the “divergence” and “convergence” constructs in table 46 are **implementation-dependent parameters**.

Table 46 - Sequence evolution

No.	Example	Rule
1	<pre> +-----+ S3 +-----+ + c +-----+ S4 +-----+ </pre>	<p>Single sequence: The alternation step-transition is repeated in series.</p> <p>Example: An evolution from step S3 to step S4 shall take place if and only if step S3 is in the active state and the transition condition c is true.</p>
2a	<pre> +-----+ S5 +-----+ +-----*-----+... + e + f +-----+ +-----+ S6 S8 +-----+ +-----+ </pre>	<p>Divergence of sequence selection: A selection between several sequences is represented by as many transition symbols, <i>under</i> the horizontal line, as there are different possible evolutions. The asterisk denotes left-to-right priority of transition evaluations.</p> <p>Example: An evolution shall take place from S5 to S6 only if S5 is active and the transition condition e is true, or from S5 to S8 only if S5 is active and f is true and e is false.</p>
2b	<pre> +-----+ S5 +-----+ +-----*-----+... 2 1 + e + f +-----+ +-----+ S6 S8 +-----+ +-----+ </pre>	<p>Divergence of sequence selection: The asterisk, followed by numbered branches, indicates a user-defined priority of transition evaluation, with the lowest-numbered branch having the highest priority.</p> <p>Example: An evolution shall take place from S5 to S8 only if S5 is active and the transition condition f is true, or from S5 to S6 only if S5 is active, and e is true, and f is false.</p>
2c	<pre> +-----+ S5 +-----+ +-----+-----+... +e +NOT e & f +-----+ +-----+ S6 S8 +-----+ +-----+ </pre>	<p>Divergence of sequence selection: The connection of the branch indicates that the user must assure that transition conditions are mutually exclusive, as specified by IEC 60848.</p> <p>Example: An evolution shall take place from S5 to S6 only if S5 is active and the transition condition e is true, or from S5 to S8 only if S5 is active and e is false and f is true.</p>

<http://www.china-gauges.com/>

Table 46 - Sequence evolution

No.	Example	Rule
3	<pre> +-----+ +-----+ S7 S9 +-----+ +-----+ + h + j +-----+-----+-----+ +-----+ S10 +-----+ </pre>	<p>Convergence of sequence selection: The end of a sequence selection is represented by as many transition symbols, <i>above</i> the horizontal line, as there are selection paths to be ended.</p> <p>Example: An evolution shall take place from S7 to S10 only if S7 is active and the transition condition h is true, or from S9 to S10 only if S9 is active and j is true.</p>
4	<pre> +-----+ S11 +-----+ + b ==+=====+=====+=====... +-----+ +-----+ S12 S14 +-----+ +-----+ </pre>	<p>Simultaneous sequences - divergence: Only one common transition symbol shall be possible, <i>above</i> the double horizontal line of synchronization.</p> <p>Example: An evolution shall take place from S11 to S12, S14,... only if S11 is active and the transition condition "b" associated to the common transition is true. After the simultaneous activation of S12, S14, etc., the evolution of each sequence proceeds independently.</p>
	<pre> +-----+ +-----+ S13 S15 +-----+ +-----+ +-----+-----+-----+ + d +-----+ S16 +-----+ </pre>	<p>Simultaneous sequences - convergence: Only one common transition symbol shall be possible, <i>under</i> the double horizontal line of synchronization.</p> <p>Example: An evolution shall take place from S13, S15,... to S16 only if all steps above and connected to the double horizontal line are active and the transition condition "d" associated to the common transition is true.</p>

<http://www.china-gauges.com/>

Table 46 - Sequence evolution

No.	Example	Rule
<p>5a 5b 5c</p>	<pre> +-----+ S30 +-----+ +---*---+ + a +d +-----+ S31 +-----+ + b +-----+ S32 +-----+ + c +-----+ +-----+ S33 +-----+ </pre>	<p>Sequence skip: A “sequence skip” is a special case of sequence selection (feature 2) in which one or more of the branches contain no steps. Features 5a, 5b, and 5c correspond to the representation options given in features 2a, 2b, and 2c, respectively.</p> <p>Example: (feature 5a shown) An evolution shall take place from S30 to S33 if “a” is false and “d” is true, that is, the sequence (S31, S32) will be skipped.</p>
<p>6a 6b 6c</p>	<pre> +-----+ S30 +-----+ + a +-----+ +-----+ S31 +-----+ + b +-----+ S32 +-----+ +-----+ +-----+ +-----+ +-----+ +-----+ S33 +-----+ </pre>	<p>Sequence loop: A “sequence loop” is a special case of sequence selection (feature 2) in which one or more of the branches returns to a preceding step. Features 6a, 6b, and 6c correspond to the representation options given in features 2a, 2b, and 2c, respectively.</p> <p>Example: (feature 6a shown) An evolution shall take place from S32 to S31 if “c” is false and “d” is true, that is, the sequence (S31, S32) will be repeated.</p>

<http://www.china-gauges.com/>

Table 46 - Sequence evolution

No.	Example	Rule
7	<pre> +-----+ S30 +-----+ + a +-----<-----+ +-----+ S31 +-----+ + b +-----+ S32 +-----+ *-----+ + c + d +-----+ +-----+ S33 +-----+ </pre>	<p>Directional arrows:</p> <p>When necessary for clarity, the “less than” (<) character of the character set defined in 2.2.1 can be used to indicate right-to-left control flow, and the “greater than” (>) character to represent left-to-right control flow. When this feature is used, the corresponding character shall be located between two “-” characters, that is, in the character sequence “-<-” or “->-” as shown in the accompanying example.</p>

<http://www.china-gauges.com/>

a) Transition not enabled
($x = 0$ or 1)

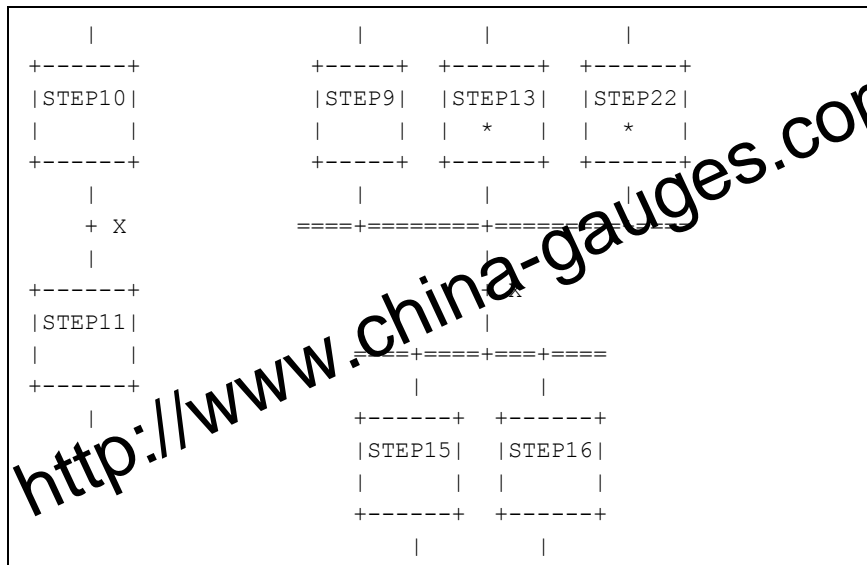

b) Transition enabled but not cleared
($x = 0$)

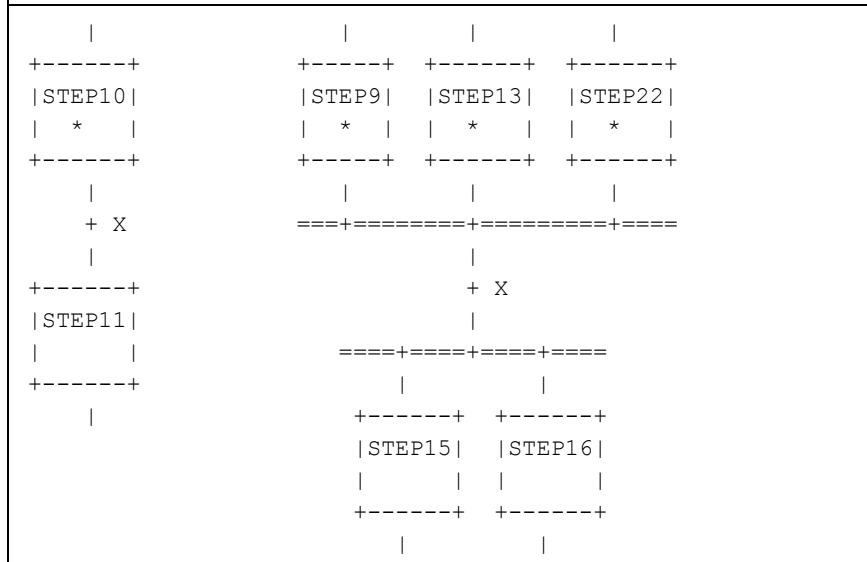

c) Transition cleared
($x = 1$)

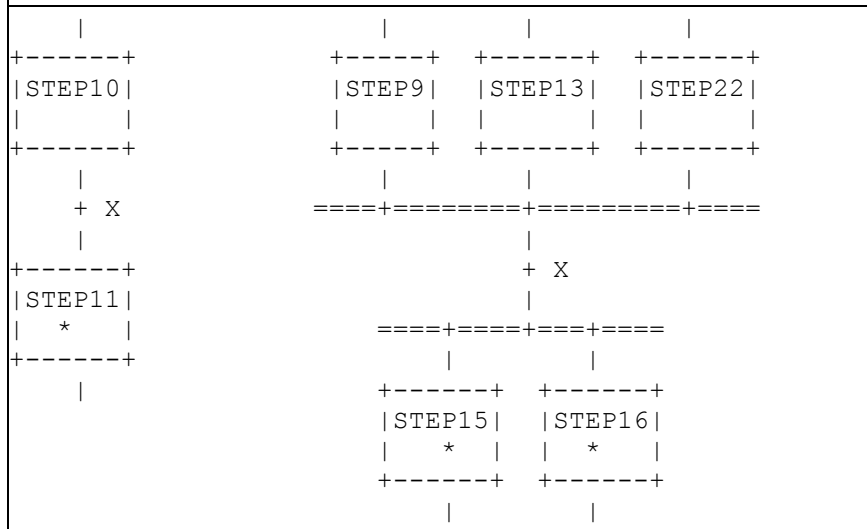

IEC 2490/02

NOTE In this figure, the active state of a step is indicated by the presence of an asterisk (*) in the corresponding block. This notation is used for illustration only, and is not a required language feature.

Figure 17 - Examples of SFC evolution rules

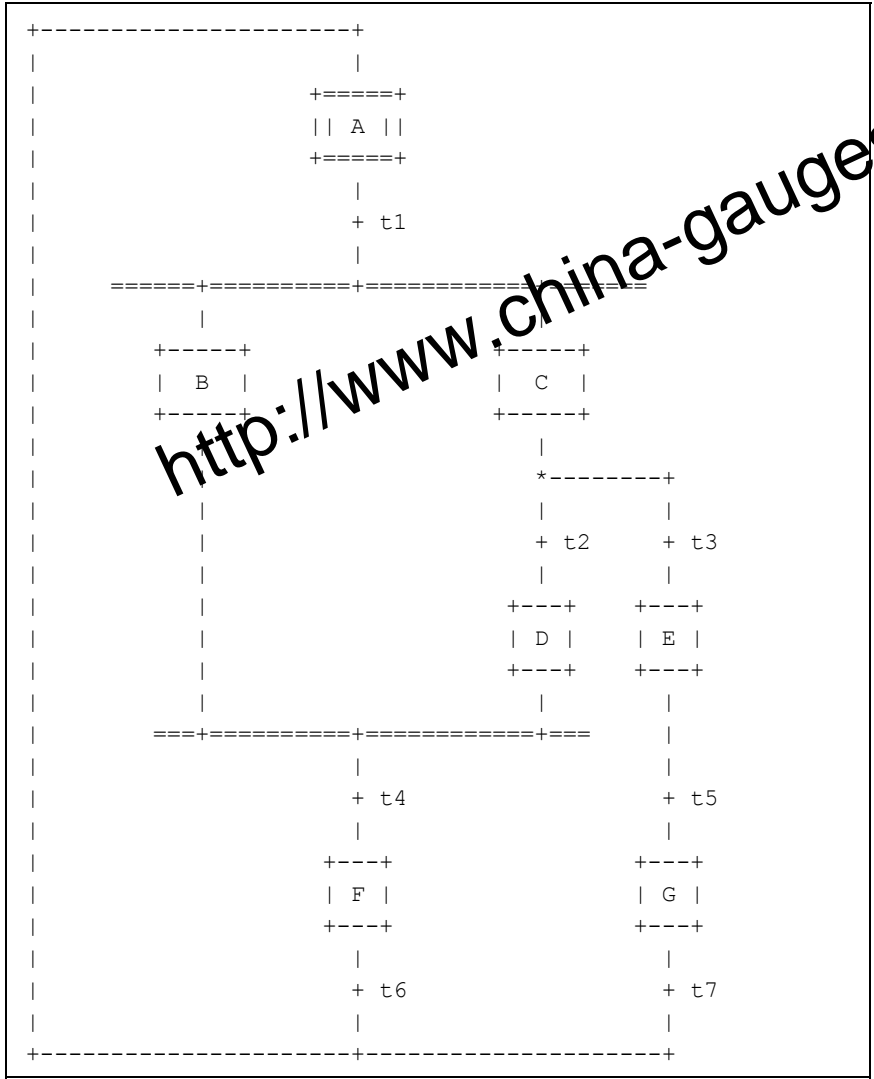

IEC 2491/02

Figure 18 a) - Examples of SFC errors: an “unsafe” SFC (see 2.6.5)

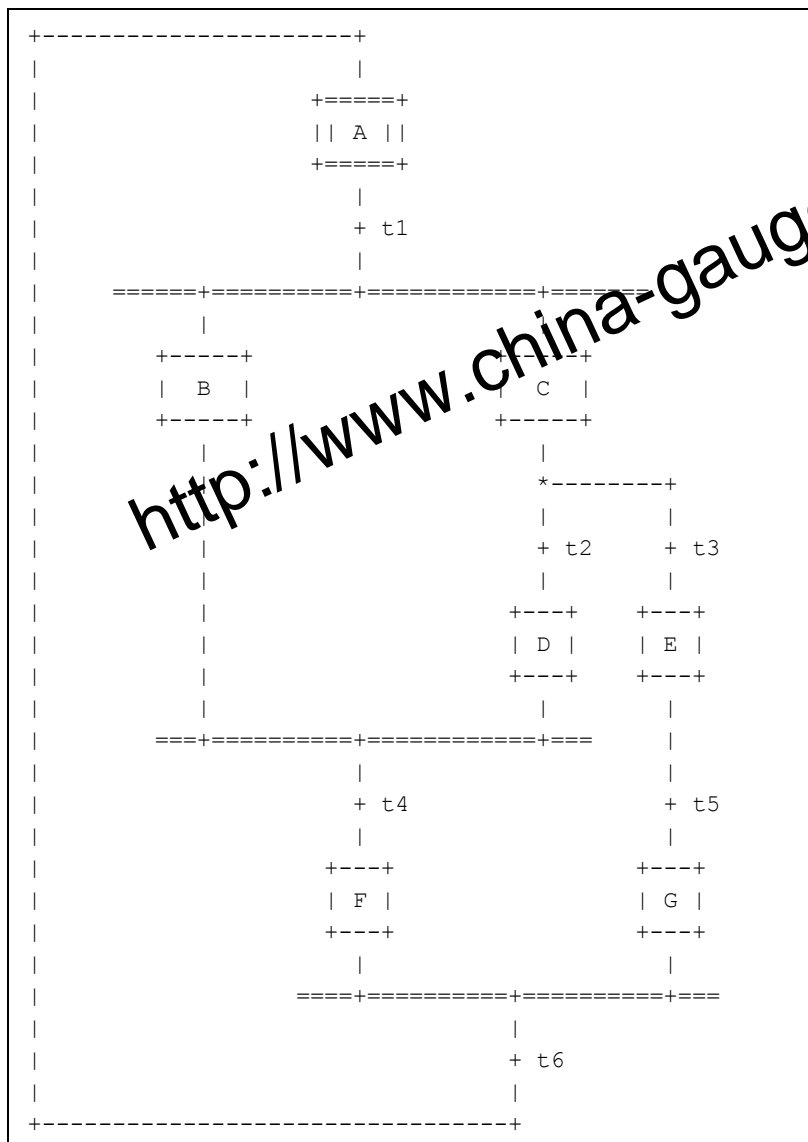

IEC 2492/02

Figure 18 b) - Examples of SFC errors: an “unreachable” SFC (see 2.6.5)

2.6.6 Compatibility of SFC elements

SFCs can be represented graphically or textually, utilizing the elements defined above. Table 47 summarizes for convenience those elements which are mutually compatible for graphical and textual representation, respectively.

<http://www.china-gauges.com/>

Table 47 - Compatible SFC features

Table	Graphical representation	Textual representation
40	1, 3a, 3b, 4	2, 3a, 4
41	1, 2, 3, 4, 4a, 4b, 7, 7a, 7b	5, 6, 7c, 7d
42	1, 2l, 2s, 2f	3s, 3
43	1, 2, 4	3
44	1 to 9	--
45	1 to 10	1 to 10 (textual equivalent)
46	1 to 7	1 to 6
57	All	--

2.6.7 SFC Compliance requirements

In order to claim compliance with the requirements of 2.6, the elements shown in table 48 shall be supported and the compatibility requirements defined in 2.6.6 shall be observed.

Table 48 - SFC minimal compliance requirements

Table	Graphical representation	Textual representation
40	1	2
41	1 or 2 or 3 or (4 and (4a or 4b)) or (7 and (7a or 7b or 7c or 7d))	5 or 6
42	1 or 2l or 2f	1 or 3s or 3i
43	1 or 2 or 4	3
45	1 or 2	1 or 2
46	1 and (2a or 2b or 2c) and 3 and 4	Same (textual equivalent)
57	(1 or 2) and (3 or 4) and (5 or 6) and (7 or 8) and (9 or 10) and (11 or 12)	Not required

2.7 Configuration elements

As described in 1.4.1, a *configuration* consists of *resources*, *tasks* (which are defined within *resources*), *global variables*, *access paths* and instance specific initializations. Each of these elements is defined in detail in this subclause.

A graphic example of a simple configuration is shown in figure 19 a). Skeleton declarations for the corresponding function blocks and programs are given in figure 19 b). This figure serves as a reference point for the examples of configuration elements given in the remainder of this subclause such as in figure 20.

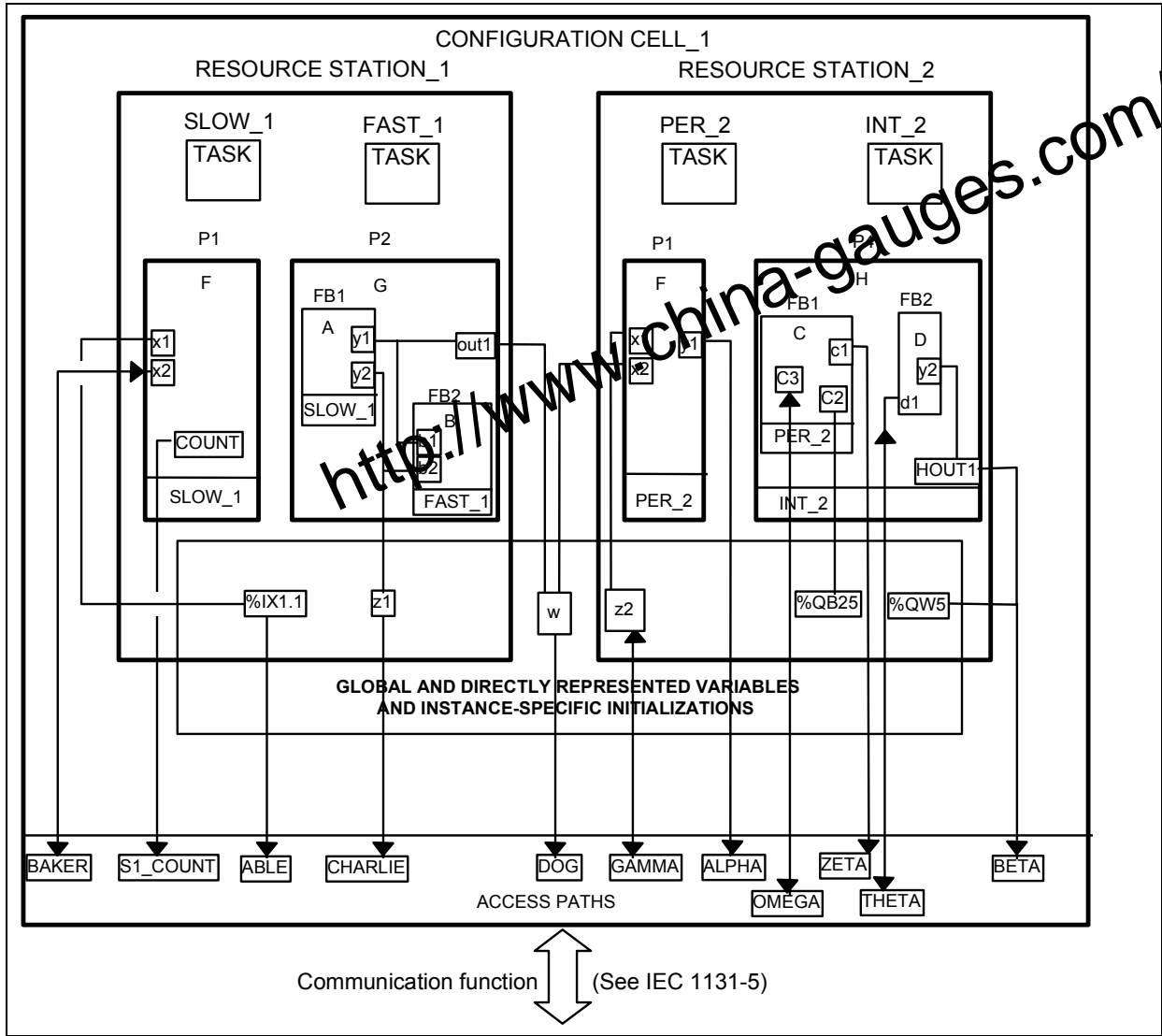

IEC 2493/02

Figure 19 a) - Graphical example of a configuration

<pre> FUNCTION_BLOCK A VAR_OUTPUT y1 : UINT ; y2 : BYTE ; END_VAR END_FUNCTION_BLOCK </pre>	<pre> FUNCTION_BLOCK B VAR_INPUT b1 : UINT ; b2 : BYTE ; END_VAR END_FUNCTION_BLOCK </pre>
<pre> FUNCTION_BLOCK C VAR_OUTPUT c1 : BOOL ; END_VAR VAR C2 AT %Q* : BYTE; C3 : INT; END_VAR END_FUNCTION_BLOCK </pre>	<pre> FUNCTION_BLOCK D VAR_INPUT d1 : BOOL ; END_VAR VAR_OUTPUT y2 : INT ; END_VAR END_FUNCTION_BLOCK </pre>
<pre> PROGRAM F VAR_INPUT x1 : BOOL ; x2 : UINT ; END_VAR VAR_OUTPUT y1 : BYTE ; END_VAR VAR COUNT : INT; TIME1 : TON; END_VAR END_PROGRAM </pre>	
<pre> PROGRAM G VAR_OUTPUT out1 : UINT ; END_VAR VAR_EXTERNAL z1 : BYTE ; END_VAR VAR FB1 : A ; FB2 : B ; END_VAR FB1(...); out1 := FB1.y1; z1 := FB1.y2; FB2(b1 := FB1.y1, b2 := FB1.y2) ; END_PROGRAM </pre>	
<pre> PROGRAM H VAR_OUTPUT HOUT1 : INT ; END_VAR VAR FB1 : C ; FB2 : D ; END_VAR FB1(...); FB2(...); HOUT1 := FB2.y2; END_PROGRAM </pre>	

IEC 2494/02

Figure 19 b) - Skeleton function block and program declarations for configuration example

2.7.1 Configurations, resources, and access paths

Table 49 enumerates the language features for declaration of *configurations*, *resources*, *global variables*, *access paths* and instance specific initializations. Partial enumeration of *TASK* declaration features is also given; additional information on *tasks* is provided in 2.7.2. The formal syntax for these features is given in B.1.7. Figure 20 provides examples of these features, corresponding to the example configuration shown in figure 19 a) and the supporting declarations in figure 19 b).

The *ON* qualifier in the *RESOURCE...ON...END_RESOURCE* construction is used to specify the type of “processing function” and its “man-machine interface” and “sensor and actuator interface” functions upon which the *resource* and its associated *programs* and *tasks* are to be implemented. The manufacturer shall supply an **implementation-dependent resource library** of such functions, as illustrated in figure 3. Associated with each element in this library shall be an identifier (the *resource type name*) for use in resource declaration.

NOTE The *RESOURCE...ON...END_RESOURCE* construction is not required in a *configuration* with a single *resource*. See the production *single_resource_declaration* in B.1.7 for the syntax to be used in this case.

The *scope* of a VAR_GLOBAL declaration shall be limited to the *configuration* or *resource* in which it is declared, with the exception that an *access path* can be declared to a *global* variable in a *resource* using feature 10d in table 49.

The VAR_ACCESS...END_VAR construction provides a means of specifying variable names which can be used for remote access by some of the communication services specified in IEC 61131-5. An *access path* associates each such variable name with a *global* variable, a *directly represented* variable as defined in 2.4.1.1, or any *input*, *output*, or internal variable of a *program* or *function block*.

The association shall be accomplished by qualifying the name of the variable with the complete hierarchical concatenation of instance names, beginning with the name of the resource (if any), followed by the name of the program instance (if any), followed by the name(s) of the function block instance(s) (if any). The name of the variable is concatenated at the end of the chain. All names in the concatenation shall be separated by dots. If such a variable is a *multi-element variable* (*structure* or *array*), an access path can also be specified to an element of the variable.

It shall not be possible to define *access paths* to variables that are declared in VAR_TEMP, VAR_EXTERNAL or VAR_IN_OUT declarations.

The direction of the access path can be specified as READ_WRITE or READ_ONLY, indicating that the communication services can both read and modify the value of the variable in the first case, or read but not modify the value in the second case. If no direction is specified, the default direction is READ_ONLY.

Access to variables that are declared CONSTANT or to function block inputs that are externally connected to other variables shall be READ_ONLY.

NOTE The effect of using READ_WRITE access to function block output variables is **implementation-dependent**.

The VAR_CONFIG...END_VAR construction provides a means to assign instance specific locations to symbolically represented variables, which are nominated for the respective purpose by using the asterisk notation described in 2.4.1.1 and 2.4.3.1, respectively, or to assign instance specific initial values to symbolically represented variables, or both.

The assignment shall be accomplished by qualifying the name of the object to be located or initialized with the complete hierarchical concatenation of instance names, beginning with the name of the resource (if any), followed by the name of the program instance, followed by the name(s) of the function block instance(s) (if any). The name of the object to be located or initialized is concatenated at the end of the chain. All names in the concatenation shall be separated by dots. The location assignment or the initial value assignment follows the syntax and the semantics described in 2.4.3.1 and 2.4.3.2 respectively.

Instance specific initial values provided by the VAR_CONFIG...END_VAR construction always override type specific initial values. It shall not be possible to define instance specific initializations to variables which are declared in VAR_TEMP, VAR_EXTERNAL, VAR_CONSTANT or VAR_IN_OUT declarations.

<http://www.china-gauges.com/>

Table 49 - Configuration and resource declaration features

No.	Description
1	CONFIGURATION...END_CONFIGURATION construction
2	VAR_GLOBAL...END_VAR construction within CONFIGURATION
3	RESOURCE...ON...END_RESOURCE construction
4	VAR_GLOBAL...END_VAR construction within RESOURCE
5a	Periodic TASK construction (see note 1)
5b	Non-periodic TASK construction (see note 1)
6a	WITH construction for PROGRAM to TASK association (see note 1)
6b	WITH construction for Function Block to TASK association (see note 1)
6c	PROGRAM declaration with no TASK association (see note 1)
7	Declaration of directly represented variables in VAR_GLOBAL (see note 2)
8a	Connection of directly represented variables to PROGRAM inputs
8b	Connection of GLOBAL variables to PROGRAM inputs
9a	Connection of PROGRAM outputs to directly represented variables
9b	Connection of PROGRAM outputs to GLOBAL variables
10a	VAR_ACCESS...END_VAR construction
10b	Access paths to directly represented variables
10c	Access paths to PROGRAM inputs
10d	Access paths to GLOBAL variables in RESOURCEs
10e	Access paths to GLOBAL variables in CONFIGURATIONs
10f	Access paths to PROGRAM outputs
10g	Access paths to PROGRAM internal variables
10h	Access paths to function block inputs
10i	Access paths to function block outputs
11	VAR_CONFIG...END_VAR construction ^a
12a	VAR_GLOBAL CONSTANT in RESOURCE declarations
12b	VAR_GLOBAL CONSTANT in CONFIGURATION declarations
13a	VAR_EXTERNAL in RESOURCE declarations
13b	VAR_EXTERNAL CONSTANT in RESOURCE declarations
NOTE 1	See 2.7.2 for further descriptions of TASK features.
NOTE 2	See 2.4.3.1 for further descriptions of related features.
^a This feature shall be supported if feature 10 in table 15 is supported.	

Figure 20 - Examples of CONFIGURATION and RESOURCE declaration features

No.	Example
1	CONFIGURATION CELL_1
2	VAR_GLOBAL w: UINT; END_VAR
3	RESOURCE STATION_1 ON PROCESSOR_TYPE_1
4	VAR_GLOBAL z1: BYTE; END_VAR
5a	TASK SLOW_1 (INTERVAL := t#20ms, PRIORITY := 2) ;
5a	TASK FAST_1 (INTERVAL := t#10ms, PRIORITY := 1) ;
6a	PROGRAM P1 WITH SLOW_1 :
8a	F(x1 := %IX1.1) ;
9b	PROGRAM P2 : G(OUT1 => w,
6b	FB1 WITH SLOW_1,
6b	FB2 WITH FAST_1) ;
3	END_RESOURCE
3	RESOURCE STATION_2 ON PROCESSOR_TYPE_2
4	VAR_GLOBAL z2 : BOOL ;
7	AT %QW5 : INT ;
4	END_VAR
5a	TASK PER_2 (INTERVAL := t#50ms, PRIORITY := 2) ;
5b	TASK INT_2 (SINGLE := z2, PRIORITY := 1) ;
6a	PROGRAM P1 WITH PER_2 :
8b	F(x1 := z2, x2 := w) ;
6a	PROGRAM P4 WITH INT_2 :
9a	H(HOUT1 => %QW5,
6b	FB1 WITH PER_2);
3	END_RESOURCE
10a	VAR_ACCESS
10b	ABLE : STATION_1.%IX1.1 : BOOL READ_ONLY ;
10c	BAKER : STATION_1.P1.x2 : UINT READ_WRITE ;
10d	CHARLIE : STATION_1.z1 : BYTE ;
10e	DOG : w : UINT READ_ONLY ;
10f	ALPHA : STATION_2.P1.y1 : BYTE READ_ONLY ;
10f	BETA : STATION_2.P4.HOUT1 : INT READ_ONLY ;
10d	GAMMA : STATION_2.z2 : BOOL READ_WRITE ;
10g	S1_COUNT : STATION_1.P1.COUNT : INT;
10h	THETA : STATION_2.P4.FB2.d1 : BOOL READ_WRITE;
10i	ZETA : STATION_2.P4.FB1.c1 : BOOL READ_ONLY;
10k	OMEGA : STATION_2.P4.FB1.C3 : INT READ_WRITE;

<http://www.china-gauges.com/>

Figure 20 - Examples of CONFIGURATION and RESOURCE declaration features

No.	Example
10a	END_VAR
11	<pre> VAR_CONFIG STATION_1.P1.COUNT : INT := 1; STATION_2.P1.COUNT : INT := 100; STATION_1.P1.TIME1 : TON := (PT := T#2.5s); STATION_2.P1.TIME1 : TON := (PT := T#4.5s); STATION_2.P4.FB1.C2 AT %QB25 : BVAR; END_VAR </pre>
1	END_CONFIGURATION
NOTE 1	Graphical and semigraphic representation of these features is allowed but is beyond the scope of this part of IEC 61131.
NOTE 2	It is an error if the data type declared for a variable in a VAR_ACCESS statement is not the same as the data type declared for the variable elsewhere, e.g., if variable BAKER is declared of type WORD in the above examples.

IEC 2495/02

2.7.2 Tasks

For the purposes of this part of IEC 61131, a *task* is defined as an execution control element which is capable of invoking, either on a periodic basis or upon the occurrence of the rising edge of a specified Boolean variable, the execution of a set of program organization units, which can include *programs* and *function blocks* whose instances are specified in the declaration of *programs*.

The maximum number of tasks per *resource* and task interval resolution are **implementation-dependent parameters**.

Tasks and their association with program organization units can be represented graphically or textually using the WITH construction, as shown in table 50, as part of *resources* within *configurations*. A task is implicitly enabled or disabled by its associated resource according to the mechanisms defined in 1.4.1. The control of program organization units by enabled tasks shall conform to the following rules:

- 1) The associated program organization units shall be scheduled for execution upon each rising edge of the SINGLE input of the task.
- 2) If the INTERVAL input is non-zero, the associated program organization units shall be scheduled for execution periodically at the specified interval as long as the SINGLE input stands at zero (0). If the INTERVAL input is zero (the default value), no periodic scheduling of the associated program organization units shall occur.
- 3) The PRIORITY input of a task establishes the scheduling priority of the associated program organization units, with zero (0) being highest priority and successively lower priorities having successively higher numeric values. As shown in table 50, the priority of a program organization unit (that is, the priority of its associated task) can be used for *preemptive* or *non-preemptive* scheduling.

- a) In *non-preemptive* scheduling, processing power becomes available on a *resource* when execution of a program organization unit or operating system function is complete. When processing power is available, the program organization unit with highest scheduled priority shall begin execution. If more than one program organization unit is waiting at the highest scheduled priority, then the program organization unit with the longest waiting time at the highest scheduled priority shall be executed.
- b) In *preemptive* scheduling, when a program organization unit is scheduled, it can *interrupt* the execution of a program organization unit of lower priority on the same *resource*, that is, the execution of the lower-priority unit can be suspended until the execution of the higher-priority unit is completed. A program organization unit shall not interrupt the execution of another unit of the same or higher priority.

NOTE Depending on schedule priorities, a program organization unit might not begin execution at the instant it is scheduled. However, in the examples shown in table 50, all program organization units meet their *deadlines*, that is, they all complete execution before being scheduled for re-execution. The manufacturer shall provide information to enable the user to determine whether all deadlines will be met in a proposed configuration.

- 4) A *program* with no task association shall have the lowest system priority. Any such program shall be scheduled for execution upon “starting” of its *resource*, as defined in 1.4.1, and shall be re-scheduled for execution as soon as its execution terminates.
- 5) When a *function block instance* is associated with a task, its execution shall be under the exclusive control of the task, independent of the rules of evaluation of the program organization unit in which the task-associated function block instance is declared.
- 6) Execution of a *function block instance* which is not directly associated with a task shall follow the normal rules for the order of evaluation of language elements for the program organization unit (which can itself be under the control of a task) in which the function block instance is declared.
- 7) The execution of function blocks within a program shall be synchronized to ensure that data concurrency is achieved according to the following rules:
- a) If a function block receives more than one input from another function block, then when the former is executed, all inputs from the latter shall represent the results of the same evaluation. For instance, in the example represented by figure 21 a), when $Y2$ is evaluated, the inputs $Y2.A$ and $Y2.B$ shall represent the outputs $Y1.C$ and $Y1.D$ from the same (not two different) evaluations of $Y1$.
- b) If two or more function blocks receive inputs from the same function block, and if the “destination” blocks are all explicitly or implicitly associated with the same task, then the inputs to all such “destination” blocks at the time of their evaluation shall represent the results of the same evaluation of the “source” block. For instance, in the example represented by figures 21 b) and 21 c), when $Y2$ and $Y3$ are evaluated in the normal course of evaluating program $P1$, the inputs $Y2.A$ and $Y2.B$ shall be the results of the same evaluation of $Y1$ as the inputs $Y3.A$ and $Y3.B$.

Provision shall be made for storage of the outputs of functions or function blocks which have explicit task associations, or which are used as inputs to program organization units which have explicit task associations, as necessary to satisfy the rules given above.

It shall be an **error** in the sense of subclause 1.5.1 if a task fails to be scheduled or to meet its execution deadline because of excessive resource requirements or other task scheduling conflicts.

Table 50 - Task features

No.	Description/Examples
1a	Textual declaration of periodic TASK (feature 5a of table 49)
1b	Textual declaration of non-periodic TASK (feature 6b of table 49)
Graphical representation of TASKs (general form)	
<pre> TASKNAME +-----+ TASK +-----+ BOOL--- SINGLE TIME--- INTERVAL UINT--- PRIORITY +-----+ </pre>	
2a	<p style="text-align: center;">Graphical representation of periodic TASKs</p> <pre> SLOW_1 FAST_1 +-----+ +-----+ TASK TASK SINGLE SINGLE t#20ms--- INTERVAL t#10ms--- INTERVAL 2--- PRIORITY 1--- PRIORITY +-----+ +-----+ </pre>
2b	<p style="text-align: center;">Graphical representation of non-periodic TASK</p> <pre> INT_2 +-----+ TASK %IX2--- SINGLE INTERVAL 1--- PRIORITY +-----+ </pre>
3a	Textual association with PROGRAMs (feature 6a of table 49)
3b	Textual association with function blocks (feature 6b of table 49)
4a	<p style="text-align: center;">Graphical association with PROGRAMs</p> <pre> RESOURCE STATION_2 P1 P4 +-----+ +-----+ F H +-----+ +-----+ PER_2 INT_2 +-----+ +-----+ END_RESOURCE </pre>

http://www.china-gauges.com/

Table 50 - Task features

No.	Description/Examples		
5a	Non-preemptive scheduling		
	EXAMPLE 2: - RESOURCE STATION_2 as configured in figure 20 - Execution times: P1 = 30 ms, P4 = 5 ms, P4.FB1 = 10 ms (see note 4) - INT_2 is triggered at t = 25, 50, 90, ... ms - STATION_2 starts at t = 0		
	SCHEDULE		
	t(ms)	Executing	Waiting
	0	P1@2	P4.FB1@2
	25	P1@2	P4.FB1@2, P4@1
	30	P4@1	P4.FB1@2
	35	P4.FB1@2	
	50	P4@1	P1@2, P4.FB1@2
	55	P1@2	P4.FB1@2
	85	P4.FB1@2	
	90	P4.FB1@2	P4@1
95	P4@1		
100	P1@2	P4.FB1@2	
5b	Preemptive scheduling		
	EXAMPLE 3: - RESOURCE STATION_1 as configured in figure 20 - Execution times: P1 = 2 ms; P2 = 8 ms; P2.FB1 = P2.FB2 = 2 ms (see note 3) - STATION_1 starts at t = 0		
	SCHEDULE		
	t(ms)	Executing	Waiting
	0	P2.FB2@1	P1@2, P2.FB1@2, P2
	2	P1@2	P2.FB1@2, P2
	4	P2.FB1@2	P2
	6	P2	
	10	P2.FB2@1	P2
	12	P2	
	16	P2	(P2 restarts)
	20	P2.FB2@1	P1@2, P2.FB1@2, P2

http://www.china-gauges.com/

Table 50 - Task features

No.	Description/Examples		
5b	Preemptive scheduling		
	EXAMPLE 4: - RESOURCE STATION_2 as configured in figure 20 - Execution times: P1 = 30 ms, P4 = 5 ms, P4.FB1 = 10 ms (note 4) - INT_2 is triggered at t = 25, 50, 90, ... ms - STATION_2 starts at t = 0		
	SCHEDULE		
	t(ms)	Executing	Waiting
	0	P1@2	P4.FB1@2
	25	P4@1	P1@2, P4.FB1@2
	30	P1@2	P4.FB1@2
	35	P4.FB1@2	
	50	P4@1	P1@2, P4.FB1@2
	55	P1@2	P4.FB1@2
	85	P4.FB1@2	
90	P4@1	P4.FB1@2	
95	P4.FB1@2		
100	P1@2	P4.FB1@2	
NOTE 1	Details of RESOURCE and PROGRAM declarations are not shown; see 2.7 and 2.7.1.		
NOTE 2	The notation X@Y indicates that program organization unit X is scheduled or executing at priority Y.		
NOTE 3	The execution times of P2.FB1 and P2.FB2 are not included in the execution time of P2.		
NOTE 4	The execution time of P4.FB1 is not included in the execution time of P4.		

http://www.china-gauges.com/

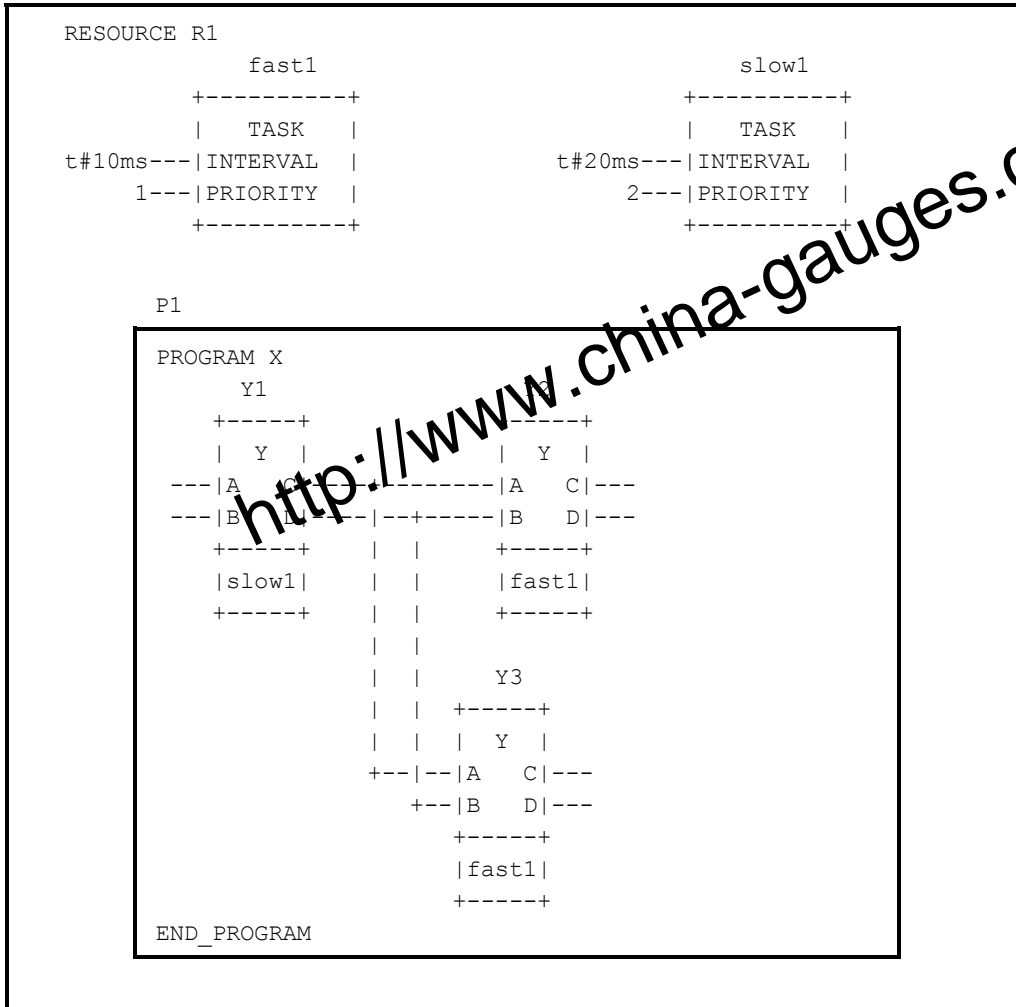

IEC 2496/02

Figure 21 a) - Synchronization of function blocks with explicit task associations

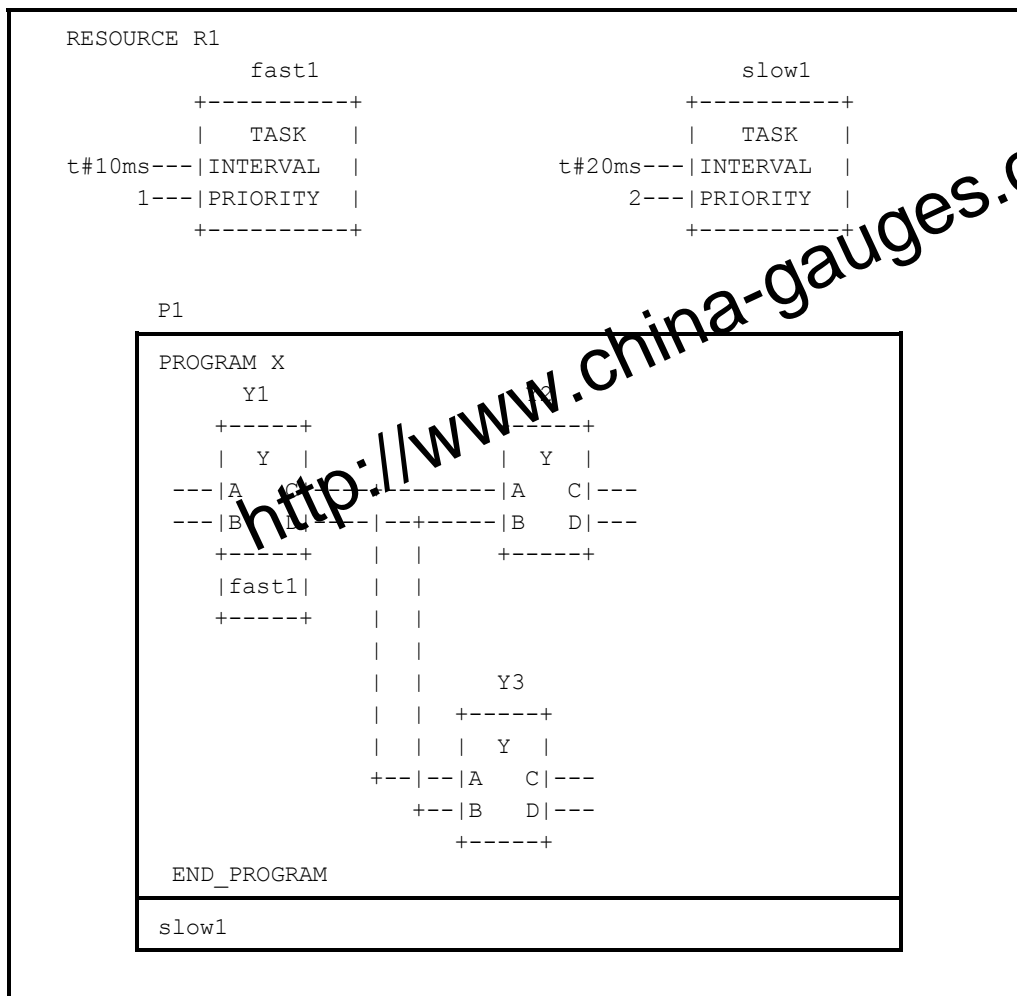

IEC 2497/02

Figure 21 b) - Synchronization of function blocks with implicit task associations

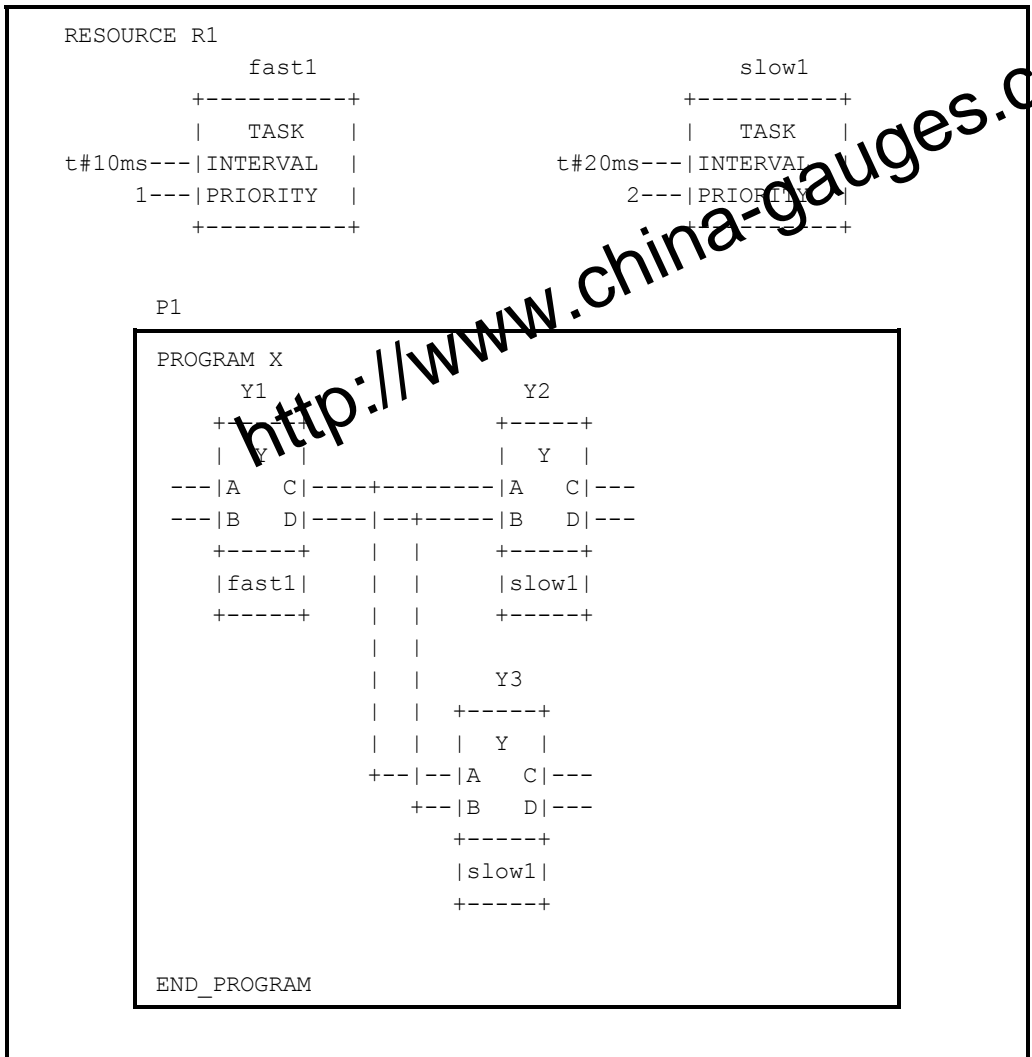

IEC 2498/02

Figure 21 c) - Explicit task associations equivalent to figure 21 b)

3 Textual languages

The textual languages defined in this standard are IL (Instruction List) and ST (Structured Text). The sequential function chart (SFC) elements defined in 2.6 can be used in conjunction with either of these languages.

3.1 Common elements

The textual elements specified in clause 2 shall be common to the textual languages (IL and ST) defined in this clause. In particular, the following program structuring elements shall be common to textual languages:

TYPE...END_TYPE	(2.3.3)
VAR...END_VAR	(2.4.3)
VAR_INPUT...END_VAR	(2.4.3)
VAR_OUTPUT...END_VAR	(2.4.3)
VAR_IN_OUT...END_VAR	(2.4.3)
VAR_EXTERNAL...END_VAR	(2.4.3)
VAR_TEMP...END_VAR	(2.4.3)
VAR_ACCESS...END_VAR	(2.4.3)
VAR_GLOBAL...END_VAR	(2.4.3)
VAR_CONFIG...END_VAR	(2.4.3)
FUNCTION ... END_FUNCTION	(2.5.1.3)
FUNCTION_BLOCK...END_FUNCTION_BLOCK	(2.5.2.2)
PROGRAM...END_PROGRAM	(2.5.3)
STEP...END_STEP	(2.6.2)
TRANSITION...END_TRANSITION	(2.6.3)
ACTION...END_ACTION	(2.6.4)

3.2 Instruction list (IL)

This subclause defines the semantics of the IL (Instruction List) language whose formal syntax is given in B.2.

3.2.1 Instructions

As illustrated in table 51, an *instruction list* is composed of a sequence of *instructions*. Each instruction shall begin on a new line and shall contain an *operator* with optional *modifiers*, and, if necessary for the particular operation, one or more *operands* separated by commas. Operands can be any of the data representations defined in 2.2 for literals, in 2.3.3 for enumerated values, and in 2.4 for variables.

The instruction can be preceded by an identifying *label* followed by a colon (:). Empty lines can be inserted between instructions.

Table 51 a) - Examples of instruction fields

LABEL	OPERATOR	OPERAND	COMMENT
START:	LD	%IX1	(* PUSH BUTTON *)
	ANDN	%MX5	(* NOT INHIBITED *)
	ST	%QX2	(* FAN ON *)

3.2.2 Operators, modifiers and operands

Standard operators with their allowed modifiers and operands shall be as listed in table 52. The typing of operators shall conform to the conventions of 2.5.1.4.

Unless otherwise defined in table 52, the semantics of the operators shall be

$$\text{result} := \text{result OP operand}$$

That is, the value of the expression being evaluated is replaced by its current value operated upon by the operator with respect to the operand. For instance, the instruction AND %IX1 is interpreted as

$$\text{result} := \text{result AND \%IX1}$$

The comparison operators shall be interpreted with the current result to the left of the comparison and the operand to the right, with a Boolean result. For instance, the instruction "GT %IW10" will have the Boolean result 1 if the current result is greater than the value of Input Word 10, and the Boolean result 0 otherwise.

The modifier "N" indicates bitwise Boolean negation (one's complement) of the operand. For instance, the instruction ANDN %IX2 is interpreted as

$$\text{result} := \text{result AND NOT \%IX2}$$

It shall be an **error** in the sense of subclause 1.5.1 if the current result and operand are not of same data type, or if the result of a numerical operation exceeds the range of values for its data type.

The left parenthesis modifier "(" indicates that evaluation of the operator shall be deferred until a right parenthesis operator ")" is encountered. In table 51 b) two equivalent forms of a parenthesized sequence of instructions are shown. Both features in table 51 b) shall be interpreted as

$$\text{result} := \text{result AND (\%IX1 OR \%IX2)}$$

<http://www.china-gauges.com/>

Table 51 b) - Parenthesized expression features for IL language

No.	DESCRIPTION/EXAMPLE
1	Parenthesized expression beginning with explicit operator: AND (LD %IX1 (NOTE 1) OR %IX2)
2	Parenthesized expression (short form): AND(%IX1 OR %IX2)
NOTE In form 1 the LD operator may be modified or the LD operation may be replaced by another operation or function invocation respectively.	

The modifier "C" indicates that the associated instruction shall be performed only if the value of the currently evaluated result is Boolean 1 (or Boolean 0 if the operator is combined with the "N" modifier).

Table 52 - Instruction list operators

No.	OPERATOR ^a	MODIFIERS (Note 1)	SEMANTICS
1	LD	N	Set current result equal to operand
2	ST	N	Store current result to operand location
3	S ^e R ^e		Set operand to 1 if current result is Boolean 1 Reset operand to 0 if current result is Boolean 1
4	AND	N, (Logical AND
5	&	N, (Logical AND
6	OR	N, (Logical OR
7	XOR	N, (Logical exclusive OR
7a	NOT ^d		Logical negation (one's complement)
8	ADD	(Addition
9	SUB	(Subtraction
10	MUL	(Multiplication
11	DIV	(Division
11a	MOD	(Modulo-division
12	GT	(Comparison: >
13	GE	(Comparison: >=
14	EQ	(Comparison: =
15	NE	(Comparison: <>
16	LE	(Comparison: <=
17	LT	(Comparison: <
18	JMP ^b	C, N	Jump to label
19	CAL ^c	C, N	Call function block (See table 53)

<http://www.china-gauges.com/>

Table 52 - Instruction list operators

No.	OPERATOR ^a	MODIFIERS (Note 1)	SEMANTICS
20	RET ^f	C, N	Return from called function, function block or program
21) ^f		Evaluate deferred operation
NOTE See preceding text for explanation of modifiers and evaluation of expressions.			
<p>^a Unless otherwise noted, these operators shall be either overloaded or typed as defined in 2.5.1.4 and 2.5.1.5.6.</p> <p>^b The operand of a JMP instruction shall be the label of an instruction to which execution is to be transferred. When a JMP instruction is contained in an ACTION... END_ACTION construct, the operand shall be a label within the same construct.</p> <p>^c The operand of this instruction shall be the name of a function block <i>instance</i> to be <i>invoked</i>.</p> <p>^d The result of this operation shall be the bitwise Boolean negation (one's complement) of the current result.</p> <p>^e The type of the operand of this instruction shall be <code>BOOL</code>.</p> <p>^f This instruction does not have an operand.</p>			

3.2.3 Functions and function blocks

Functions as defined in 2.5.1 shall be invoked by placing the function name in the operator field. As shown in features 4 and 5 of table 53, this invocation can take one of two forms. The value returned by a function upon the successful execution of a RET instruction or upon reaching the physical end of the function shall become the "current result" described in 3.2.2.

The argument list of functions (feature 4 in table 53) is equivalent to feature 1 in table 19 a). The rules and features defined in 2.5.1.1 and table 19 a) for function calls apply.

A non-formal input list of functions (feature 5 in table 53) is equivalent to feature 2 in table 19 a). The rules and features defined in 2.5.1.1 and table 19 a) for function calls apply. In contrast to the examples given in table 19 a) for ST language, the first argument is not contained in the non-formal input list in IL, but the current result shall be used as the first argument of the function. Additional arguments (starting with the 2nd), if required, shall be given in the operand field, separated by commas, in the order of their declaration.

Function blocks as defined in 2.5.2 can be invoked conditionally and unconditionally via the CAL (Call) operator listed in table 52. As shown in features 1a, 1b, 2 and 3 of table 53, this invocation can take one of four forms.

A formal argument list of a function block invocation (feature 1a in table 53) is equivalent to feature 1 in table 19 a). A non-formal argument list of a function block invocation (feature 1b in table 53) is equivalent to feature 2 in table 19 a). The rules and features defined in 2.5.1.1 and table 19 a) for function calls apply correspondingly, by replacing each occurrence of the term 'function' by the term 'function block' in these rules.

All assignments in an argument list of a conditional function block invocation shall only be performed together with the invocation, if the condition is true.

Table 53 - Function block invocation and Function invocation features for IL language

No.	DESCRIPTION/EXAMPLE
1a	CAL of function block with non-formal argument list:
	<pre> CAL C10(%IX10, FALSE, A, OUT, B) CAL CMD_TMR(%IX5, T#300ms, OUT, ELAPSED) </pre>
1b	CAL of function block with formal argument list:
	<pre> CAL C10(CU := %IX10, Q => OUT) CAL CMD_TMR(MN := %IX5, PT := T#300ms, Q => OUT, ET => ELAPSED, ENO => ERR) </pre>
2	CAL of function block with load/store of arguments (note 2)
	<pre> LD A ADD 5 ST C10.PV LD %IX10 ST C10.CU CAL C10 </pre>
3	Use of function block input operators:
	<pre> LD A ADD 5 PV C10 LD %IX10 CU C10 </pre>
4	Function invocation with formal argument list:
	<pre> LIMIT(EN:= COND, IN:= B, MN:= 1, MX:= 5, ENO=> TEMPL) ST A </pre>
5	Function invocation with non-formal argument list:
	<pre> LD 1 LIMIT B, 5 ST A </pre>

<http://www.china-gauges.com/>

Table 53 - Function block invocation and Function invocation features for IL language

No.	DESCRIPTION/EXAMPLE
	<p>NOTE 1 A declaration such as</p> <pre> VAR C10 : CTU; CMD_TMR : TON; A, B : INT; ELAPSED : TIME; OUT, ERR, TEMPL, COLD, BOOL; END_VAR </pre> <p>is assumed in the above examples.</p> <p>NOTE 2 This usage is an exception to the rule given in 2.5.2.1 that "The assignment of a value to the inputs of a function block is permitted only as part of the invocation of the function block."</p>

The input operators shown in table 54 can be used in conjunction with feature 3 of table 53. This method of invocation is equivalent to a `CAL` with an argument list, which contains only one variable with the name of the input operator. Arguments, which are not supplied, are taken from the last assignment or, if not present, from initialization. This feature supports problem situations, where events are predictable and therefore only one variable can change from one call to the next.

EXAMPLE 1

Together with the declaration

```
VAR C10: CTU; END_VAR
```

the instruction sequence

```
LD 15
PV C10
```

gives the same result as

```
CAL C10 (PV:=15)
```

The missing inputs `R` and `CU` have values previously assigned to them. Since the `CU` input detects a rising edge, only the `PV` input value will be set by this call; counting cannot happen because an unsupplied argument cannot change. In contrast to this, the sequence

```
LD %IX10
CU C10
```

results in counting at maximum in every second call, depending on the change rate of the input `%IX10`. Every call uses the previously set values for `PV` and `R`.

EXAMPLE 2

With bistable function blocks, taking a declaration

```
VAR FORWARD: SR; END_VAR
```

this results into an implicit conditional behavior. The sequence

```
LD FALSE
S1 FORWARD
```

does not change the state of the bistable `FORWARD`. A following sequence

```
LD TRUE
R FORWARD
```

resets the bistable.

Table 54 - Standard function block input operators for IL language

No.	Operators	FB Type	Reference
4	S1, R	SR	2.5.2.3.1
5	S, R1	RS	2.5.2.3.1
6	CLK	TRIGGER	2.5.2.3.1
8	CU, R, PV	CTU	2.5.2.3.3
9	CD, PV	CTD	2.5.2.3.3 (note 1)
10	CU, CD, R, PV	CTUD	2.5.2.3.3 (note 1)
11	IN, PT	TP	2.5.2.3.4
12	IN, PT	TON	2.5.2.3.4
13	IN, P	TOF	2.5.2.3.4
NOTE 1 LD is not necessary as a Standard Function Block input operator, because the LD functionality is included in PV.			
NOTE 2 The feature numbering in this table is such as to maintain consistency with the first edition of IEC 61131-3.			

3.3 Structured Text (ST)

This subclause defines the semantics of the ST (Structured Text) language whose syntax is defined in B.3. In this language, the end of a textual line shall be treated the same as a space (SP) character, as defined in 2.1.4.

3.3.1 Expressions

An *expression* is a construct which, when evaluated, yields a value corresponding to one of the data types defined in 2.3.1 and 2.3.3. The maximum allowed length of expressions is an **implementation-dependent parameter**.

Expressions are composed of operators and operands. An *operand* shall be a literal as defined in 2.2, an enumerated value as defined in 2.3.3, a variable as defined in 2.4, a function invocation as defined in 2.5.1, or another expression.

The *operators* of the ST language are summarized in table 55. The evaluation of an expression consists of applying the operators to the operands in a sequence defined by the operator precedence shown in table 55. The operator with highest precedence in an expression shall be applied first, followed by the operator of next lower precedence, etc., until evaluation is complete. Operators of equal precedence shall be applied as written in the expression from left to right. For example, if A, B, C, and D are of type INT with values 1, 2, 3, and 4, respectively, then

$$A+B-C*ABS(D)$$

shall evaluate to -9, and

$$(A+B-C)*ABS(D)$$

shall evaluate to 0.

<http://www.china-gauges.com/>

When an operator has two operands, the leftmost operand shall be evaluated first. For example, in the expression

$$\text{SIN}(A) * \text{COS}(B)$$

the expression $\text{SIN}(A)$ shall be evaluated first, followed by $\text{COS}(B)$, followed by evaluation of the product.

The following conditions in the execution of operators shall be treated as errors in the sense of subclause 1.5.1:

- 1) An attempt is made to divide by zero.
- 2) Operands are not of the correct data type for the operation.
- 3) The result of a numerical operation exceeds the range of values for its data type.

Boolean expressions may be evaluated only to the extent necessary to determine the resultant value. For instance, if $A \leq B$, then only the expression $(A > B)$ would be evaluated to determine that the value of the expression

$$(A > B) \ \& \ (C < D)$$

is Boolean zero.

Functions shall be invoked as elements of expressions consisting of the function name followed by a parenthesized list of arguments, as defined in 2.5.1.1.

When an operator in an expression can be represented as one of the overloaded functions defined in 2.5.1.5, conversion of operands and results shall follow the rule and examples given in 2.5.1.4.

<http://www.china-gauges.com/>

Table 55 - Operators of the ST language

No.	Operation ^a	Symbol	Precedence
1	Parenthesization	(expression)	HIGHEST
2	Function evaluation EXAMPLES	identifier(argument list) LN(A), MAX(X,Y), etc.	
4	Negation	-	
5	Complement	NOT	
3	Exponentiation ^b	**	
6	Multiply	*	
7	Divide	/	
8	Modulo	MOD	
9	Add	+	
10	Subtract	-	
11	Comparison	< , > , <= , >=	
12	Equality	=	
13	Inequality	<>	
14	Boolean AND	&	
15	Boolean AND	AND	
16	Boolean Exclusive OR	XOR	
17	Boolean OR	OR	LOWEST
NOTE The feature numbering in this table is such as to maintain consistency with the first edition of IEC 61131-3.			
^a The same restrictions apply to the operands of these operators as to the inputs of the corresponding functions defined in 2.5.1.5.			
^b The result of evaluating the expression A**B shall be the same as the result of evaluating the function EXPT(A, B) as defined in table 24.			

3.3.2 Statements

The statements of the ST language are summarized in table 56. Statements shall be terminated by semicolons as specified in the syntax of B.3. The maximum allowed length of statements is an **implementation-dependent parameter**.

Table 56 - ST language statements

No.	Statement type/Reference	Examples
1	Assignment (3.3.2.1)	A := B; CV := CV+1; C := SQRT(X);
2	Function block Invocation and FB output usage (3.3.2.2)	CMD_TMR(IN:=%IX5, RT:=T#300ms) ; A := CMD_TMR ;
3	RETURN (3.3.2.2)	RETURN ;
4	IF (3.3.2.3)	D := B*B - 4*A*C ; IF D < 0.0 THEN NROOTS := 0 ; ELSIF D = 0.0 THEN NROOTS := 1 ; X1 := - B/(2.0*A) ; ELSE NROOTS := 2 ; X1 := (- B + SQRT(D))/(2.0*A) ; X2 := (- B - SQRT(D))/(2.0*A) ; END_IF ;
5	CASE (3.3.2.3)	TW := BCD_TO_INT(THUMBWHEEL) ; TW_ERROR := 0 ; CASE TW OF 1,5: DISPLAY := OVEN_TEMP ; 2: DISPLAY := MOTOR_SPEED ; 3: DISPLAY := GROSS - TARE ; 4,6..10: DISPLAY := STATUS(TW - 4) ; ELSE DISPLAY := 0 ; TW_ERROR := 1 ; END_CASE ; QW100 := INT_TO_BCD(DISPLAY) ;
6	FOR (3.3.2.4)	J := 101 ; FOR I := 1 TO 100 BY 2 DO IF WORDS[I] = 'KEY' THEN J := I ; EXIT ; END_IF ; END_FOR ;
7	WHILE (3.3.2.4)	J := 1 ; WHILE J <= 100 & WORDS[J] <> 'KEY' DO J := J+2 ; END_WHILE ;
8	REPEAT (3.3.2.4)	J := -1 ; REPEAT J := J+2 ; UNTIL J = 101 OR WORDS[J] = 'KEY' END_REPEAT ;
9	EXIT (3.3.2.4) ^a	EXIT ;
10	Empty Statement	;

^a If the EXIT statement (9) is supported, then it shall be supported for all of the iteration statements (FOR, WHILE, REPEAT) which are supported in the implementation.

<http://www.china-gauges.com/>

3.3.2.1 Assignment statements

The assignment statement replaces the current value of a single or multi-element variable by the result of evaluating an expression. An assignment statement shall consist of a variable reference on the left-hand side, followed by the *assignment operator* “:=”, followed by the expression to be evaluated. For instance, the statement

```
A := B ;
```

would be used to replace the single data value of variable *A* by the current value of variable *B* if both were of type *INT*. However, if both *A* and *B* were of type *ANALOG_CHANNEL_CONFIGURATION* as described in table 12, then the values of all the elements of the structured variable *A* would be replaced by the current values of the corresponding elements of variable *B*.

As illustrated in figure 6, the assignment statement shall also be used to assign the value to be returned by a function, by placing the function name to the left of an assignment operator in the body of the function declaration. The value returned by the function shall be the result of the most recent evaluation of such an assignment. It is an **error** to return from the evaluation of a function with an *ENO* value of *TRUE*, or with a non-existent *ENO* output, unless at least one such assignment has been made.

3.3.2.2 Function and function block control statements

Function and function block control statements consist of the mechanisms for invoking function blocks and for returning control to the invoking entity before the physical end of a function or function block.

Function evaluation shall be invoked as part of expression evaluation, as specified in 3.3.1.

Function blocks shall be invoked by a statement consisting of the name of the function block instance followed by a parenthesized list of arguments, as illustrated in table 56. The rules and features defined in 2.5.1.1 and table 19 a) for function calls apply correspondingly, by replacing each occurrence of the term ‘function’ by the term ‘function block’ in these rules.

The *RETURN* statement shall provide early exit from a function, function block or program (for example, as the result of the evaluation of an *IF* statement).

3.3.2.3 Selection statements

Selection statements include the *IF* and *CASE* statements. A selection statement selects one (or a group) of its component statements for execution, based on a specified condition. Examples of selection statements are given in table 56.

The *IF* statement specifies that a group of statements is to be executed only if the associated Boolean expression evaluates to the value 1 (true). If the condition is false, then either no statement is to be executed, or the statement group following the *ELSE* keyword (or the *ELSIF* keyword if its associated Boolean condition is true) is to be executed.

The *CASE* statement consists of an expression which shall evaluate to a variable of type *ANY_INT* or of an enumerated data type (the “selector”), and a list of statement groups, each group being labeled by one or more integer or enumerated values or ranges of integer values, as applicable. It specifies that the first group of statements, one of whose ranges contains the computed value of the selector, shall be executed. If the value of the selector does not occur in a range of any case, the statement sequence following the keyword *ELSE* (if it occurs in the *CASE* statement) shall be executed. Otherwise, none of the statement sequences shall be executed.

The maximum allowed number of selections in *CASE* statements is an **implementation-dependent parameter**.

3.3.2.4 Iteration statements

Iteration statements specify that the group of associated statements shall be executed repeatedly. The `FOR` statement is used if the number of iterations can be determined in advance; otherwise, the `WHILE` or `REPEAT` constructs are used.

The `EXIT` statement shall be used to terminate iterations before the termination condition is satisfied.

When the `EXIT` statement is located within nested iterative constructs, exit shall be from the innermost loop in which the `EXIT` is located, that is, control shall pass to the next statement after the first loop terminator (`END_FOR`, `END_WHILE`, or `END_REPEAT`) following the `EXIT` statement. For instance, after executing the statements shown in figure 22, the value of the variable `SUM` shall be 15 if the value of the Boolean variable `FLAG` is 0, and 6 if `FLAG` is 1.

```

SUM := 0 ;
FOR I := 1 TO 3 DO
  FOR J := 1 TO 2 DO
    IF FLAG THEN EXIT ; END_IF
    SUM := SUM + J ;
  END_FOR ;
  SUM := SUM + I ;
END_FOR ;

```

IEC 2499/02

Figure 22 - `EXIT` statement example

The `FOR` statement indicates that a statement sequence shall be repeatedly executed, up to the `END_FOR` keyword, while a progression of values is assigned to the `FOR` loop control variable. The control variable, initial value, and final value shall be expressions of the same integer type (for example, `SINT`, `INT`, or `DINT`) and shall not be altered by any of the repeated statements. The `FOR` statement increments the control variable up or down from an initial value to a final value in increments determined by the value of an expression; this value defaults to 1. The test for the termination condition is made at the beginning of each iteration, so that the statement sequence is not executed if the initial value exceeds the final value. The value of the control variable after completion of the `FOR` loop is **implementation-dependent**.

An example of the usage of the `FOR` statement is given in feature 6 of table 56. In this example, the `FOR` loop is used to determine the index `J` of the first occurrence (if any) of the string 'KEY' in the odd-numbered elements of an array of strings `WORDS` with a subscript range of (1..100). If no occurrence is found, `J` will have the value 101.

The `WHILE` statement causes the sequence of statements up to the `END_WHILE` keyword to be executed repeatedly until the associated Boolean expression is false. If the expression is initially false, then the group of statements is not executed at all. For instance, the `FOR...END_FOR` example given in table 56 can be rewritten using the `WHILE...END_WHILE` construction shown in table 56.

The `REPEAT` statement causes the sequence of statements up to the `UNTIL` keyword to be executed repeatedly (and at least once) until the associated Boolean condition is true. For instance, the `WHILE...END_WHILE` example given in table 56 can be rewritten using the `REPEAT...END_REPEAT` construction shown in table 56.

The `WHILE` and `REPEAT` statements shall not be used to achieve interprocess synchronization, for example as a "wait loop" with an externally determined termination condition. The SFC elements defined in 2.6 shall be used for this purpose.

It shall be an **error** in the sense of 1.5.1 if a `WHILE` or `REPEAT` statement is used in an algorithm for which satisfaction of the loop termination condition or execution of an `EXIT` statement cannot be guaranteed.

<http://www.china-gauges.com/>

4 Graphic languages

The graphic languages defined in this standard are LD (Ladder Diagram) and FBD (Function Block Diagram). The sequential function chart (SFC) elements defined in 2.6 can be used in conjunction with either of these languages.

4.1 Common elements

The elements defined in this clause apply to both the graphic languages in this standard, that is, LD (Ladder Diagram) and FBD (Function Block Diagram), and to the graphic representation of sequential function chart (SFC) elements.

4.1.1 Representation of lines and blocks

The graphic language elements defined in this clause are drawn with line elements using characters from the character set defined in 2.1.1, or using graphic or semigraphic elements, as shown in table 57.

Lines can be extended by the use of *connectors* as shown in table 57. No storage of data or association with data elements shall be associated with the use of connectors; hence, to avoid ambiguity, it shall be an **error** if the identifier used as a connector label is the same as the name of another named element within the same program organization unit.

Any restrictions on network topology in a particular implementation shall be expressed as **implementation-dependent parameters**.

4.1.2 Direction of flow in networks

A *network* is defined as a maximal set of interconnected graphic elements, excluding the left and right rails in the case of networks in the LD language defined in 4.2. Provision shall be made to associate with each network or group of networks in a graphic language a *network label* delimited on the right by a colon (:). This label shall have the form of an identifier or an unsigned decimal integer as defined in clause 2. The *scope* of a network and its label shall be *local* to the program organization unit in which the network is located. Examples of networks and network labels are shown in annex F.

Graphic languages are used to represent the flow of a conceptual quantity through one or more networks representing a control plan, that is:

- "Power flow", analogous to the flow of electric power in an electromechanical relay system, typically used in relay ladder diagrams;
- "Signal flow", analogous to the flow of signals between elements of a signal processing system, typically used in function block diagrams;
- "Activity flow", analogous to the flow of control between elements of an organization, or between the steps of an electromechanical sequencer, typically used in sequential function charts.

The appropriate conceptual quantity shall flow along lines between elements of a network according to the following rules:

- 1) Power flow in the LD language shall be from left to right.
- 2) Signal flow in the FBD language shall be from the output (right-hand) side of a function or function block to the input (left-hand) side of the function or function block(s) so connected.
- 3) Activity flow between the SFC elements defined in 2.6 shall be from the bottom of a step through the appropriate transition to the top of the corresponding successor step(s).

<http://www.china-gauges.com/>

Table 57 - Representation of lines and blocks

No.	Feature	Example
1	Horizontal lines: ISO/IEC 10646-1 “minus” character	-----
2	Graphic or semigraphic	
3	Vertical lines: ISO/IEC 10646-1 “vertical line” character	
4	Graphic or semigraphic	
5	Horizontal/vertical connection: ISO/IEC 10646-1 “plus” character	+-----
6	Graphic or semigraphic	
7	Line crossings without connection: ISO/IEC 10646-1 characters	----- -----
8	Graphic or semigraphic	
9	Connected and non-connected corners: ISO/IEC 10646-1 characters	-----+ +----- -----++ +-----
10	Graphic or semigraphic	
11	Blocks with connecting lines: ISO/IEC 10646-1 characters	-----+ --- --- --- --- --- +-----+
12	Graphic or semigraphic	
13	Connectors using ISO/IEC 10646-1 characters: Connector	----->OTTO>
14	Continuation of a connected line Graphic or semigraphic connectors	>OTTO>-----

4.1.3 Evaluation of networks

The order in which networks and their elements are evaluated is not necessarily the same as the order in which they are labeled or displayed. Similarly, it is not necessary that all networks be evaluated before the evaluation of a given network can be repeated. However, when the body of a program organization unit consists of one or more networks, the results of network evaluation within the said body shall be functionally equivalent to the observance of the following rules:

- 1) No element of a network shall be evaluated until the states of all of its inputs have been evaluated.
- 2) The evaluation of a network element shall not be complete until the states of all of its outputs have been evaluated.
- 3) The evaluation of a network is not complete until the outputs of all of its elements have been evaluated, even if the network contains one of the execution control elements defined in 4.1.4.

- 4) The order in which networks are evaluated shall conform to the provisions of 4.2.6 for the LD language and 4.3.3 for the FBD language.

A *feedback path* is said to exist in a network when the output of a function or function block is used as the input to a function or function block which precedes it in the network; the associated variable is called a *feedback variable*. For instance, the Boolean variable RUN is the feedback variable in the example shown in figure 23. A feedback variable can also be an output element of a function block data structure as defined in 2.5.2.

Feedback paths can be utilized in the graphic languages defined in 4.2 and 4.3, subject to the following rules:

- 1) Explicit loops such as the one shown in figure 23 a) shall only appear in the FBD language defined in 4.3.
- 2) It shall be possible for the user to utilize an **implementation-dependent** means to determine the order of execution of the elements in an explicit loop, for instance by selection of feedback variables to form an implicit loop as shown in figure 23 b).
- 3) Feedback variables shall be initialized by one of the mechanisms defined in clause 2. The initial value shall be used during the first evaluation of the network. It shall be an **error** if a feedback variable is not initialized.
- 4) Once the element with a feedback variable as output has been evaluated, the new value of the feedback variable shall be used until the next evaluation of the element.

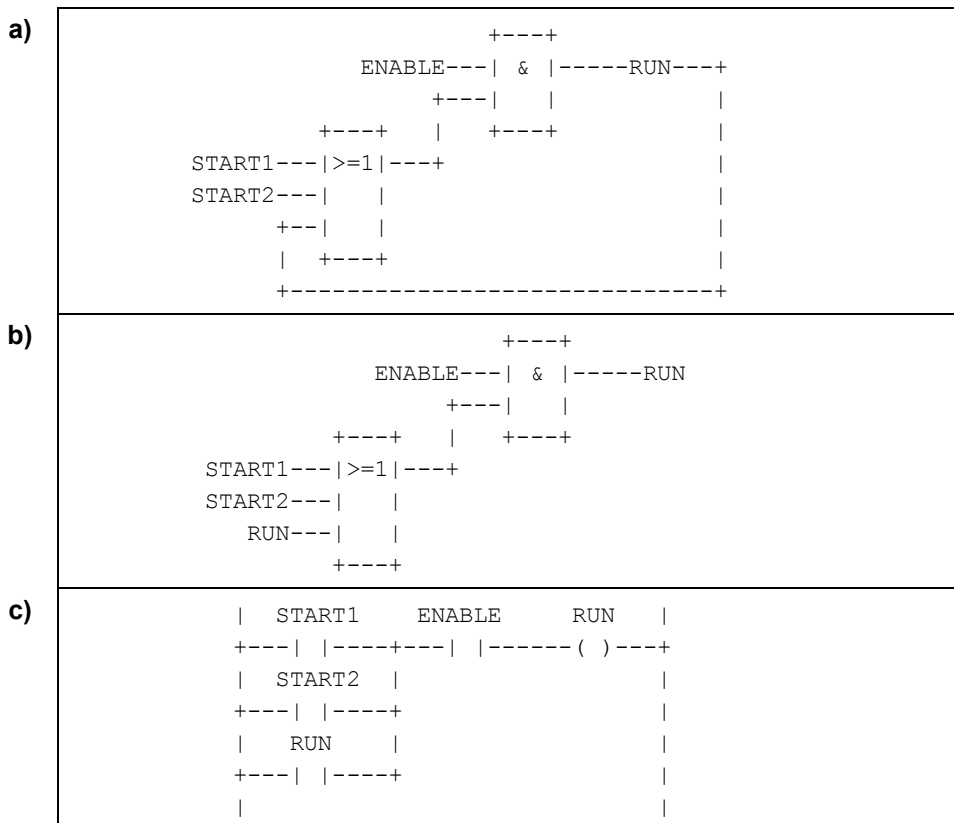

IEC 2500/02

Figure 23 - Feedback path example

a) Explicit loop

b) Implicit loop

c) LD language equivalent

4.1.4 Execution control elements

Transfer of program control in the LD and FBD languages shall be represented by the graphical elements shown in table 58.

Jumps shall be shown by a Boolean signal line terminated in a double arrowhead. The signal line for a jump condition shall originate at a Boolean variable, at a Boolean output of a function or function block, or on the power flow line of a ladder diagram. A transfer of program control to the designated network label shall occur when the Boolean value of the signal line is 1 (TRUE); thus, the unconditional jump is a special case of the conditional jump.

The target of a jump shall be a network label within the program organization unit within which the jump occurs. If the jump occurs within an ACTION...END_ACTION construct, the target of the jump shall be within the same construct.

Conditional returns from functions and function blocks shall be implemented using a RETURN construction as shown in table 58. Program execution shall be transferred back to the invoking entity when the Boolean input is 1 (TRUE), and shall continue in the normal fashion when the Boolean input is 0 (FALSE). Unconditional returns shall be provided by the physical end of the function or function block, or by a RETURN element connected to the left rail in the LD language, as shown in table 58.

Table 58 - Graphic execution control elements

No.	Symbol/Example	Explanation
1	1----->>LABELA	Unconditional Jjump: FBD language
2	 +----->>LABELA 	LD language
3	X----->>LABELB +----+ %IX20--- & ---->>NEXT %MX50--- +----+ NEXT: +----+ %IX25--- >=1 ----%QX100 %MX60--- +----+	Conditional jump (FBD language) Example: jump condition jump target
4	X +- ----->>LABELB %IX20 %MX50 +--- ----- ---->>NEXT NEXT: %IX25 %QX100 +--- -----+----()----+ %MX60 +--- -----+ 	Conditional jump (LD language) Example: jump condition jump target

Table 58 - Graphic execution control elements

No.	Symbol/Example	Explanation
5	<pre> X +--- ---<RETURN> </pre>	Conditional return: LD language
6	<pre> X---<RETURN> </pre>	FBD language
7	<pre> END_FUNCTION END_FUNCTION_BLOCK </pre>	Unconditional return: from FUNCTION from FUNCTION_BLOCK
8	<pre> +---<RETURN> </pre>	Alternative representation in LD language

4.2 Ladder diagram (LD)

This subclause defines the LD language for ladder diagram programming of programmable controllers.

A LD program enables the programmable controller to test and modify data by means of standardized graphic symbols. These symbols are laid out in networks in a manner similar to a “rung” of a relay ladder logic diagram. LD networks are bounded on the left and right by *power rails*.

4.2.1 Power rails

As shown in table 59, the LD network shall be delimited on the left by a vertical line known as the *left power rail*, and on the right by a vertical line known as the *right power rail*. The right power rail may be explicit or implied.

Table 59 - Power rails

No.	Symbol	Description
1	<pre> +--- </pre>	Left power rail (with attached horizontal link)
2	<pre> --- + </pre>	Right power rail (with attached horizontal link)

4.2.2 Link elements and states

As shown in table 60, link elements may be horizontal or vertical. The state of the link element shall be denoted “ON” or “OFF”, corresponding to the literal Boolean values 1 or 0, respectively. The term *link state* shall be synonymous with the term *power flow*.

The state of the left rail shall be considered ON at all times.. No state is defined for the right rail.

A horizontal link element shall be indicated by a horizontal line. A horizontal link element transmits the state of the element on its immediate left to the element on its immediate right.

<http://www.china-gauges.com/>

The vertical link element shall consist of a vertical line intersecting with one or more horizontal link elements on each side. The state of the vertical link shall represent the inclusive OR of the ON states of the horizontal links on its left side, that is, the state of the vertical link shall be:

- OFF if the states of all the attached horizontal links to its left are OFF;
- ON if the state of one or more of the attached horizontal links to its left is ON.

The state of the vertical link shall be copied to all of the attached horizontal links on its right. The state of the vertical link shall not be copied to any of the attached horizontal links on its left.

Table 60 - Link elements

No.	Symbol	Description
1	-----	Horizontal link
2	<pre> +-----+ +-----+ +----- </pre>	<p>Vertical link (with attached horizontal links)</p>

4.2.3 Contacts

A *contact* is an element which imparts a state to the horizontal link on its right side which is equal to the Boolean AND of the state of the horizontal link at its left side with an appropriate function of an associated Boolean input, output, or memory variable. A contact does not modify the value of the associated Boolean variable. Standard contact symbols are given in table 61.

4.2.4 Coils

A *coil* copies the state of the link on its left to the link on its right without modification, and stores an appropriate function of the state or transition of the left link into the associated Boolean variable. Standard coil symbols are given in table 62.

EXAMPLE In the rung shown below, the value of the Boolean output a is always TRUE, while the value of outputs c, d and e upon completion of an evaluation of the rung is equal to the value of the input b.

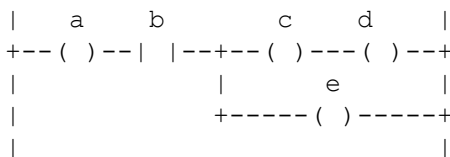

4.2.5 Functions and function blocks

The representation of functions and function blocks in the LD language shall be as defined in clause 2, with the following exceptions:

- 1) Actual variable connections may optionally be shown by writing the appropriate data or variable outside the block adjacent to the formal variable name on the inside.

- 2) At least one Boolean input and one Boolean output shall be shown on each block to allow for power flow through the block.

4.2.6 Order of network evaluation

Within a program organization unit written in LD, networks shall be evaluated in top to bottom order as they appear in the ladder diagram, except as this order is modified by the execution control elements defined in 4.1.4.

Table 61 - Contacts^a

Static contacts		
No.	Symbol	Description
1	*** -- --	Normally open contact The state of the left link is copied to the right link if the state of the associated Boolean variable (indicated by "***") is ON. Otherwise, the state of the right link is OFF.
	or *** --!!--	
3	*** -- / --	Normally closed contact The state of the left link is copied to the right link if the state of the associated Boolean variable is OFF. Otherwise, the state of the right link is OFF.
	or *** --!/!--	
Transition-sensing contacts		
5	*** -- P --	Positive transition-sensing contact The state of the right link is ON from one evaluation of this element to the next when a transition of the associated variable from OFF to ON is sensed at the same time that the state of the left link is ON. The state of the right link shall be OFF at all other times.
	or *** --!P!--	
7	*** -- N --	Negative transition-sensing contact The state of the right link is ON from one evaluation of this element to the next when a transition of the associated variable from ON to OFF is sensed at the same time that the state of the left link is ON. The state of the right link shall be OFF at all other times.
	or *** --!N!--	
^a As specified in 2.1.1, the exclamation mark "!" shall be used when a national character set does not support the vertical bar " ".		

<http://www.china-gauges.com/>

Table 62 - Coils

No.	Symbol	Description
Momentary coils		
1	*** -- () --	Coil The state of the left link is copied to the associated Boolean variable and to the right link.
2	*** -- (/) --	Negated coil The state of the left link is copied to the right link. The inverse of the state of the left link is copied to the associated Boolean variable, that is, if the state of the left link is OFF, then the state of the associated variable is ON, and vice versa.
Latched Coils		
3	*** -- (S) --	SET (latch) coil The associated Boolean variable is set to the ON state when the left link is in the ON state, and remains set until reset by a RESET coil.
4	*** -- (R) --	RESET (unlatch) coil The associated Boolean variable is reset to the OFF state when the left link is in the ON state, and remains reset until set by a SET coil.
Transition-sensing coils		
8	*** -- (P) --	Positive transition-sensing coil The state of the associated Boolean variable is ON from one evaluation of this element to the next when a transition of the left link from OFF to ON is sensed. The state of the left link is always copied to the right link.
9	*** -- (N) --	Negative transition-sensing coil The state of the associated Boolean variable is ON from one evaluation of this element to the next when a transition of the left link from ON to OFF is sensed. The state of the left link is always copied to the right link.
NOTE Features 5, 6 and 7 of the first edition are deleted in this edition.		

<http://www.china-gauges.com/>

4.3 Function Block Diagram (FBD)

4.3.1 General

This subclause defines FBD, a graphic language for the programming of programmable controllers which is consistent, as far as possible, with IEC 60617-12. Where conflicts exist between this standard and IEC 60617-12, the provisions of this standard shall apply for the programming of programmable controllers in the FBD language.

The provisions of clause 2 and subclause 4.1 shall apply to the construction and interpretation of programmable controller programs in the FBD language.

Examples of the use of the FBD language are given in annex F.

4.3.2 Combination of elements

Elements of the FBD language shall be interconnected by signal flow lines following the conventions of 4.1.2.

Outputs of function blocks shall not be connected together. In particular, the “wired-OR” construct of the LD language is not allowed in the FBD language; an explicit Boolean “OR” block is required instead, as shown in figure 24.

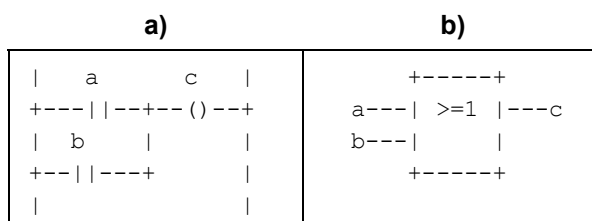

IEC 2501/02

Figure 24 - Boolean OR examples

a) “Wired-OR” in LD language

b) Function in FBD language

4.3.3 Order of network evaluation

When a program organization unit written in the FBD language contains more than one network, the manufacturer shall provide **implementation-dependent** means by which the user may determine the order of execution of networks.

ANNEX A
(normative)
Specification method for textual languages

Programming languages are specified in terms of a *syntax*, which specifies the allowable combinations of symbols which can be used to define a program; and a set of *semantics*, which specify the relationship between programmed operations and the symbol combinations defined by the syntax.

A.1 Syntax

A syntax is defined by a set of *terminal symbols* to be utilized for program specification; a set of *non-terminal symbols* defined in terms of the terminal symbols; and a set of *production rules* specifying those definitions.

A.1.1 Terminal symbols

The terminal symbols for textual programmable controller programs shall consist of combinations of the characters in the character set defined in 2.1.1.

For the purposes of this part, terminal textual symbols consist of the appropriate character string enclosed in paired single or double quotes. For example, a terminal symbol represented by the character string ABC can be represented by either

"ABC"

or

'ABC'

This allows the representation of strings containing either single or double quotes; for instance, a terminal symbol consisting of the double quote itself would be represented by ' " '.

A special terminal symbol utilized in this syntax is the end-of-line delimiter, which is represented by the unquoted character string EOL. This symbol shall normally consist of the "paragraph separator" character defined as hexadecimal code 2029 by ISO/IEC 10646-1.

A second special terminal symbol utilized in this syntax is the "null string", that is, a string containing no characters. This is represented by the terminal symbol `NIL`.

The case of letters shall not be significant in terminal symbols.

A.1.2 Non-terminal symbols

Non-terminal textual symbols shall be represented by strings of lower-case letters, numbers, and the underline character (`_`), beginning with a lower-case letter. For instance, the strings

`nonterm1`

and

`non_term_2`

are valid non-terminal symbols, while the strings

`3nonterm`

and

`_nonterm4`

are not.

http://www.china-gauges.com/

A.1.3 Production rules

The production rules for textual programmable controller programming languages shall form an *extended grammar* in which each rule has the form

$$\text{non_terminal_symbol} ::= \text{extended_structure}$$

This rule can be read as:

“A non_terminal_symbol can consist of an extended_structure.”

Extended structures can be constructed according to the following rules:

- 1) The null string, *NIL*, is an extended structure.
- 2) A terminal symbol is an extended structure.
- 3) A non-terminal symbol is an extended structure.
- 4) If *s* is an extended structure, then the following expressions are also extended structures:
 - (*s*), meaning *s* itself.
 - {*s*}, *closure*, meaning zero or more concatenations of *s*.
 - [*s*], *option*, meaning zero or one occurrence of *s*.
- 5) If *s*₁ and *s*₂ are extended structures, then the following expressions are extended structures:
 - s*₁ | *s*₂, *alternation*, meaning a choice of *s*₁ or *s*₂.
 - s*₁ *s*₂, *concatenation*, meaning *s*₁ followed by *s*₂.
- 6) Concatenation *precedes* alternation, that is, *s*₁ | *s*₂ *s*₃ is equivalent to *s*₁ | (*s*₂ *s*₃), and *s*₁ *s*₂ | *s*₃ is equivalent to (*s*₁ *s*₂) | *s*₃.

A.2 Semantics

Programmable controller textual programming language semantics are defined in this part of IEC 61131 by appropriate natural language text, accompanying the production rules, which references the descriptions provided in the appropriate clauses. Standard options available to the user and manufacturer are specified in these semantics.

In some cases it is more convenient to embed semantic information in an extended structure. In such cases, this information is delimited by paired angle brackets, for example, <semantic information>.

http://www.china-gauges.com/

ANNEX B
(normative)
Formal specifications of language elements

B.0 Programming model

The contents of this annex are normative in the sense that a compiler which is capable of recognizing all the syntax in this annex shall be capable of recognizing the syntax of any textual language implementation complying with this standard.

PRODUCTION RULES:

```
library_element_name ::= data_type_name | function_name
                    | function_block_type_name | program_type_name
                    | resource_type_name | configuration_name

library_element_declaration ::= data_type_declaration
                             | function_declaration | function_block_declaration
                             | program_declaration | configuration_declaration
```

SEMANTICS: These productions reflect the basic programming model defined in 1.4.3, where *declarations* are the basic mechanism for the production of named *library elements*. The syntax and semantics of the non-terminal symbols given above are defined in the subclauses listed below.

Non-terminal symbol	Syntax	Semantics
data_type_name data_type_declaration	B.1.3	2.3
function_name function_declaration	B.1.5.1	2.5.1
function_block_type_name function_block_declaration	B.1.5.2	2.5.2
program_type_name program_declaration	B.1.5.3	2.5.3
resource_type_name configuration_name configuration_declaration	B.1.7	2.7

B.1 Common elements**B.1.1 Letters, digits and identifiers****PRODUCTION RULES:**

```
letter ::= 'A' | 'B' | <...> | 'Z' | 'a' | 'b' | <...> | 'z'
digit  ::= '0' | '1' | '2' | '3' | '4' | '5' | '6' | '7' | '8' | '9'
octal_digit ::= '0' | '1' | '2' | '3' | '4' | '5' | '6' | '7'
hex_digit  ::= digit | 'A'|'B'|'C'|'D'|'E'|'F'
identifier ::= (letter | ('_' (letter | digit))) {'_' (letter | digit)}
```

SEMANTICS:

The ellipsis <...> here indicates the ISO/IEC 10646-1 sequence of 26 letters.

Characters from national character sets can be used; however, international portability of the printed representation of programs cannot be guaranteed in this case.

B.1.2 Constants**PRODUCTION RULE:**

```
constant ::= numeric_literal | character_string | time_literal
           | bit_string_literal | boolean_literal
```

SEMANTICS:

The external representations of data described in 2.2 are designated as “constants” in this annex.

B.1.2.1 Numeric literals**PRODUCTION RULES:**

```
numeric_literal ::= integer_literal | real_literal
integer_literal ::= [ integer_type_name '#' ]
                  ( signed_integer | binary_integer | octal_integer | hex_integer )
signed_integer ::= ['+' | '-'] integer
integer ::= digit {['_'] digit}
binary_integer ::= '2#' bit {['_'] bit}
bit ::= '1' | '0'
octal_integer ::= '8#' octal_digit {['_'] octal_digit}
hex_integer ::= '16#' hex_digit {['_'] hex_digit}
real_literal ::= [ real_type_name '#' ]
                signed_integer '.' integer [exponent]
exponent ::= ('E' | 'e') ['+' | '-'] integer
bit_string_literal ::=
  [ ('BYTE' | 'WORD' | 'DWORD' | 'LWORD') '#' ]
  ( unsigned_integer | binary_integer | octal_integer | hex_integer )
boolean_literal ::=
  ( [ 'BOOL#' ] ( '1' | '0' ) ) | 'TRUE' | 'FALSE'
```

SEMANTICS: see 2.2.1.

B.1.2.2 Character strings**PRODUCTION RULES:**

```
character_string ::=
  single_byte_character_string | double_byte_character_string
single_byte_character_string ::=
  "" {single_byte_character_representation} ""
double_byte_character_string ::=
  "" {double_byte_character_representation} ""
```

<http://www.china-gauges.com/>

```

single_byte_character_representation ::= common_character_representation
    | "$" | "'" | '$' hex_digit hex_digit

double_byte_character_representation ::= common_character_representation
    | '$"' | "" | '$' hex_digit hex_digit hex_digit hex_digit

common_character_representation ::=
    <any printable character except '$', "'" or "">
    | '$$' | '$L' | '$N' | '$P' | '$R' | '$T'
    | '$l' | '$n' | '$p' | '$r' | '$t'

```

SEMANTICS: see 2.2.2.

B.1.2.3 Time literals

PRODUCTION RULE:

```
time_literal ::= duration | time_of_day | date | date_and_time
```

SEMANTICS: see 2.2.3.

B.1.2.3.1 Duration

PRODUCTION RULES:

```

duration ::= ('T' | 'TIME') '#' ['-'] interval
interval ::= days | hours | minutes | seconds | milliseconds
days ::= fixed_point ('d') | integer ('d') ['-'] hours
fixed_point ::= integer [ '.' integer]
hours ::= fixed_point ('h') | integer ('h') ['-'] minutes
minutes ::= fixed_point ('m') | integer ('m') ['-'] seconds
seconds ::= fixed_point ('s') | integer ('s') ['-'] milliseconds
milliseconds ::= fixed_point ('ms')

```

SEMANTICS: see 2.2.3.1.

NOTE The semantics of 2.2.3.1 impose additional constraints on the allowable values of hours, minutes, seconds, and milliseconds.

B.1.2.3.2 Time of day and date

PRODUCTION RULES:

```

time_of_day ::= ('TIME_OF_DAY' | 'TOD') '#' daytime
daytime ::= day_hour ':' day_minute ':' day_second
day_hour ::= integer
day_minute ::= integer
day_second ::= fixed_point
date ::= ('DATE' | 'D') '#' date_literal
date_literal ::= year '-' month '-' day
year ::= integer

```

<http://www.china-gauges.com/>

```

month ::= integer
day ::= integer
date_and_time ::= ('DATE_AND_TIME' | 'DT') '#' date_literal '-' daytime

```

SEMANTICS: see 2.2.3.2.

NOTE The semantics of 2.2.3.2 impose additional constraints on the allowable values of `day_hour`, `day_minute`, `day_second`, `year`, `month` and `day`.

B.1.3 Data types

PRODUCTION RULES:

```

data_type_name ::= non_generic_type_name | generic_type_name
non_generic_type_name ::= elementary_type_name | derived_type_name

```

SEMANTICS: see 2.3.

B.1.3.1 Elementary data types

PRODUCTION RULES:

```

elementary_type_name ::= numeric_type_name | date_type_name
                        | bit_string_type_name | 'STRING' | 'WSTRING' | 'TIME'
numeric_type_name ::= integer_type_name | real_type_name
integer_type_name ::= signed_integer_type_name
                    | unsigned_integer_type_name
signed_integer_type_name ::= 'SINT' | 'INT' | 'DINT' | 'LINT'
unsigned_integer_type_name ::= 'USINT' | 'UINT' | 'UDINT' | 'ULINT'
real_type_name ::= 'REAL' | 'LREAL'
date_type_name ::= 'DATE' | 'TIME_OF_DAY' | 'TOD' | 'DATE_AND_TIME'
                 | 'DT'
bit_string_type_name ::= 'BOOL' | 'BYTE' | 'WORD' | 'DWORD' | 'LWORD'

```

SEMANTICS: See 2.3.1.

B.1.3.2 Generic data types

PRODUCTION RULE:

```

generic_type_name ::= 'ANY' | 'ANY_DERIVED' | 'ANY_ELEMENTARY'
                    | 'ANY_MAGNITUDE' | 'ANY_NUM' | 'ANY_REAL' | 'ANY_INT' | 'ANY_BIT'
                    | 'ANY_STRING' | 'ANY_DATE'

```

SEMANTICS: see 2.3.2.

B.1.3.3 Derived data types

PRODUCTION RULES:

```

derived_type_name ::= single_element_type_name | array_type_name
                  | structure_type_name | string_type_name
single_element_type_name ::= simple_type_name | subrange_type_name
                          | enumerated_type_name

```

<http://www.china-gauges.com/>

```

simple_type_name ::= identifier
subrange_type_name ::= identifier
enumerated_type_name ::= identifier
array_type_name ::= identifier
structure_type_name ::= identifier
data_type_declaration ::=
    'TYPE' type_declaration ';'
    {type_declaration ';' }
    'END_TYPE'
type_declaration ::= single_element_type_declaration
    | array_type_declaration
    | structure_type_declaration | string_type_declaration
single_element_type_declaration ::= simple_type_declaration
    | subrange_type_declaration | enumerated_type_declaration
simple_type_declaration ::= simple_type_name ':' simple_spec_init
simple_spec_init := simple_specification [':= ' constant]
simple_specification ::= elementary_type_name | simple_type_name
subrange_type_declaration ::= subrange_type_name ':' subrange_spec_init
subrange_spec_init ::= subrange_specification [':= ' signed_integer]
subrange_specification ::= integer_type_name '(' subrange ')'
    | subrange_type_name
subrange ::= signed_integer '..' signed_integer
enumerated_type_declaration ::=
    enumerated_type_name ':' enumerated_spec_init
enumerated_spec_init ::= enumerated_specification [':= ' enumerated_value]
enumerated_specification ::=
    ( '(' enumerated_value {',' enumerated_value} ')' )
    | enumerated_type_name
enumerated_value ::= [enumerated_type_name '#'] identifier
array_type_declaration ::= array_type_name ':' array_spec_init
array_spec_init ::= array_specification [':= ' array_initialization]
array_specification ::= array_type_name
    | 'ARRAY' '[' subrange {',' subrange} ']' 'OF' non_generic_type_name
array_initialization ::=
    '[' array_initial_elements {',' array_initial_elements} ']'
array_initial_elements ::=
    array_initial_element | integer '(' [array_initial_element] ')'
array_initial_element ::= constant | enumerated_value
    | structure_initialization | array_initialization
structure_type_declaration ::=
    structure_type_name ':' structure_specification
structure_specification ::= structure_declaration | initialized_structure

```

<http://www.china-gauges.com/>

```

initialized_structure ::=
    structure_type_name [':= ' structure_initialization]

structure_declaration ::=
    'STRUCT' structure_element_declaration ';'
    {structure_element_declaration ';' }
    'END_STRUCT'

structure_element_declaration ::= structure_element_name
    (simple_spec_init | subrange_spec_init | enumerated_spec_init
    | array_spec_init | initialized_structure)

structure_element_name ::= identifier

structure_initialization ::=
    '(' structure_element_initialization
    {',' structure_element_initialization} ')'

structure_element_initialization ::=
    structure_element_name ':=' (constant | enumerated_value
    | array_initialization | structure_initialization)

string_type_name ::= identifier

string_type_declaration ::= string_type_name ':'
    ('STRING' | 'WSTRING') ['[' integer ']'] [':=' character_string]

```

SEMANTICS: see 2.3.3.

B.1.4 Variables

PRODUCTION RULES:

```

variable ::= direct_variable | symbolic_variable
symbolic_variable ::= variable_name | multi_element_variable
variable_name ::= identifier

```

SEMANTICS: see 2.4.1.

B.1.4.1 Directly represented variables

PRODUCTION RULES:

```

direct_variable ::= '%' location_prefix size_prefix integer { '.' integer }
location_prefix ::= 'I' | 'Q' | 'M'
size_prefix ::= NIL | 'X' | 'B' | 'W' | 'D' | 'L'

```

SEMANTICS: see 2.4.1.1.

B.1.4.2 Multi-element variables

PRODUCTION RULES:

```

multi_element_variable ::= array_variable | structured_variable
array_variable ::= subscripted_variable subscript_list
subscripted_variable ::= symbolic_variable
subscript_list ::= '[' subscript { ',' subscript } ']'

```

<http://www.china-gauges.com/>

```

subscript ::= expression
structured_variable ::= record_variable '.' field_selector
record_variable ::= symbolic_variable
field_selector ::= identifier

```

SEMANTICS: see 2.4.1.2.

B.1.4.3 Declaration and initialization

PRODUCTION RULES:

```

input_declarations ::=
    'VAR_INPUT' ['RETAIN' | 'NON_RETAIN']
    input_declaration ';'
    {input_declaration ';' }
    'END_VAR'

input_declaration ::= var_init_decl | edge_declaration
edge_declaration ::= varl_list ':' 'BOOL' ('R_EDGE' | 'F_EDGE')
var_init_decl ::= varl_init_decl | array_var_init_decl
    | structured_var_init_decl | fb_name_decl | string_var_declaration
varl_init_decl ::= varl_list ':'
    (simple_spec_init | subrange_spec_init | enumerated_spec_init)
varl_list ::= variable_name {',' variable_name}
array_var_init_decl ::= varl_list ':' array_spec_init
structured_var_init_decl ::= varl_list ':' initialized_structure
fb_name_decl ::= fb_name_list ':' function_block_type_name
    [ ':'= structure_initialization ]
fb_name_list ::= fb_name {',' fb_name}
fb_name ::= identifier
output_declarations ::=
    'VAR_OUTPUT' ['RETAIN' | 'NON_RETAIN']
    var_init_decl ';'
    {var_init_decl ';' }
    'END_VAR'

input_output_declarations ::=
    'VAR_IN_OUT'
    var_declaration ';'
    {var_declaration ';' }
    'END_VAR'

var_declaration ::= temp_var_decl | fb_name_decl
temp_var_decl ::= varl_declaration | array_var_declaration
    | structured_var_declaration | string_var_declaration
varl_declaration ::= varl_list ':' (simple_specification
    | subrange_specification | enumerated_specification)

```

<http://www.china-gauges.com/>

```

array_var_declaration ::= var1_list ':' array_specification
structured_var_declaration ::= var1_list ':' structure_type_name
var_declarations ::=
    'VAR' ['CONSTANT']
    var_init_decl ';'
    {(var_init_decl ';')}
    'END_VAR'

retentive_var_declarations ::=
    'VAR' 'RETAIN'
    var_init_decl ';'
    {var_init_decl ';'}
    'END_VAR'

located_var_declarations ::=
    'VAR' ['CONSTANT' 'RETAIN' | 'NON_RETAIN']
    located_var_decl ';'
    {located_var_decl ';'}
    'END_VAR'

located_var_decl ::= [variable_name] location ':' located_var_spec_init

external_var_declarations :=
    'VAR_EXTERNAL' ['CONSTANT']
    external_declaration ';'
    {external_declaration ';'}
    'END_VAR'

external_declaration ::= global_var_name ':'
    (simple_specification | subrange_specification
    | enumerated_specification | array_specification
    | structure_type_name | function_block_type_name)

global_var_name ::= identifier

global_var_declarations :=
    'VAR_GLOBAL' ['CONSTANT' | 'RETAIN']
    global_var_decl ';'
    {global_var_decl ';'}
    'END_VAR'

global_var_decl ::= global_var_spec ':'
    [ located_var_spec_init | function_block_type_name ]

global_var_spec ::= global_var_list | [global_var_name] location

located_var_spec_init ::= simple_spec_init | subrange_spec_init
    | enumerated_spec_init | array_spec_init | initialized_structure
    | single_byte_string_spec | double_byte_string_spec

location ::= 'AT' direct_variable

global_var_list ::= global_var_name {',' global_var_name}

string_var_declaration ::= single_byte_string_var_declaration
    | double_byte_string_var_declaration

single_byte_string_var_declaration ::=
    var1_list ':' single_byte_string_spec

single_byte_string_spec ::=
    'STRING' [[' integer ']] [':=' single_byte_character_string]

```

<http://www.china-gauges.com/>

```

double_byte_string_var_declaration ::=
    var1_list ':' double_byte_string_spec

double_byte_string_spec ::=
    'WSTRING' [[' integer ']] [':=' double_byte_character_string]

incompl_located_var_declarations ::=
    'VAR' ['RETAIN'|'NON_RETAIN']
        incompl_located_var_decl ';'
        {incompl_located_var_decl ';' }
    'END_VAR'

incompl_located_var_decl ::= variable_name incompl_location ':' var_spec
incompl_location ::= 'AT' '%' ('I' | 'Q' | 'M') '*'
var_spec ::= simple_specification
            | subrange_specification | enumerated_specification
            | array_specification | structure_type_name
            | 'STRING' [[' integer ']] | 'WSTRING' [[' integer ']]

```

SEMANTICS: see 2.4.2. The non-terminal `function_block_type_name` is defined in B.1.5.2.

B.1.5 Program organization units

B.1.5.1 Functions

PRODUCTION RULES:

```

function_name ::= standard_function_name | derived_function_name
standard_function_name ::= <as defined in 2.5.1.5>
derived_function_name ::= identifier
function_declaration ::=
    'FUNCTION' derived_function_name ':'
        (elementary_type_name | derived_type_name)
        { io_var_declarations | function_var_decls }
        function_body
    'END_FUNCTION'

io_var_declarations ::= input_declarations | output_declarations |
    input_output_declarations

function_var_decls ::= 'VAR' ['CONSTANT']
    var2_init_decl ';' {var2_init_decl ';' } 'END_VAR'

function_body ::= ladder_diagram | function_block_diagram
    | instruction_list | statement_list | <other languages>

var2_init_decl ::= var1_init_decl | array_var_init_decl
    | structured_var_init_decl | string_var_declaration

```

SEMANTICS: see 2.5.1.

- NOTE 1 This syntax does not reflect the fact that each function must have at least one input declaration.
- NOTE 2 This syntax does not reflect the fact that edge declarations, function block references and invocations are not allowed in function bodies.
- NOTE 3 Ladder diagrams and function block diagrams are graphically represented as defined in Clause 4. The non-terminals `instruction_list` and `statement_list` are defined in B.2.1 and B.3.2, respectively.

B.1.5.2 Function blocks

PRODUCTION RULES:

```

function_block_type_name ::= standard_function_block_name
    | derived_function_block_name

standard_function_block_name ::= <as defined in 2.5.2.3>

derived_function_block_name ::= identifier

function_block_declaration ::=
    'FUNCTION_BLOCK' derived_function_block_name
    { io_var_declarations | other_var_declarations }
    function_block_body
    'END_FUNCTION_BLOCK'

other_var_declaration ::= external_var_declarations | var_declarations
    | retentive_var_declarations | non_retentive_var_declarations
    | temp_var_decls | incompl_located_var_declarations

temp_var_decls ::=
    'VAR_TEMP'
    temp_var_decl ';'
    {temp_var_decl ';' }
    'END_VAR'

non_retentive_var_decls ::=
    'VAR' 'NON_RETAIN'
    var_init_decl ';'
    {var_init_decl ';' }
    'END_VAR'

function_block_body ::= sequential_function_chart | ladder_diagram
    | function_block_diagram | instruction_list | statement_list
    | <other languages>

```

SEMANTICS: see 2.5.2.

- NOTE 1 Ladder diagrams and function block diagrams are graphically represented as defined in clause 4.
- NOTE 2 The non-terminals `sequential_function_chart`, `instruction_list`, and `statement_list` are defined in B.1.6, B.2.1, and B.3.2, respectively.

<http://www.china-gauges.com/>

B.1.5.3 Programs**PRODUCTION RULES:**

```

program_type_name ::= = identifier

program_declaration ::=
    'PROGRAM' program_type_name
    { io_var_declarations | other_var_declarations
      | located_var_declarations | program_access_decls }
    function_block_body
    'END_PROGRAM'

program_access_decls ::=
    'VAR_ACCESS' program_access_decl ';'
    {program_access_decl }
    'END_VAR'

program_access_decl ::= access_name ':' symbolic_variable ':'
    non_generic_type_name [direction]

```

SEMANTICS: see 2.5.3.

B.1.6 Sequential function chart elements**PRODUCTION RULES:**

```

sequential_function_chart ::= sfc_network {sfc_network}

sfc_network ::= initial_step {step | transition | action}

initial_step ::=
    'INITIAL_STEP' step_name ':' {action_association ';'} 'END_STEP'

step ::= 'STEP' step_name ':' {action_association ';'} 'END_STEP'

step_name ::= identifier

action_association ::=
    action_name '(' [action_qualifier] {',' indicator_name} ')'

action_name ::= identifier

action_qualifier ::=
    'N' | 'R' | 'S' | 'P' | timed_qualifier ',' action_time

timed_qualifier ::= 'L' | 'D' | 'SD' | 'DS' | 'SL'

action_time ::= duration | variable_name

indicator_name ::= variable_name

transition ::= 'TRANSITION'
    [transition_name] ['(' 'PRIORITY' ':= ' integer ')']
    'FROM' steps 'TO' steps
    transition_condition
    'END_TRANSITION'

transition_name ::= identifier

steps ::= step_name | '(' step_name ',' step_name {',' step_name} ')'

transition_condition ::= ':' simple_instruction_list | ':=' expression
    ';' | ':' (fbd_network | rung)

```

<http://www.china-gauges.com/>

```

action ::= 'ACTION' action_name ':'
        function_block_body
        'END_ACTION'

```

SEMANTICS: see 2.6. The use of function block diagram networks and ladder diagram rungs, denoted by the non-terminals `fbd_network` and `rung`, respectively, for the expression of transition conditions shall be as defined in 2.6.3.

NOTE 1 The non-terminals `simple_instruction_list` and `expression` are defined in B.2.1 and B.3.1, respectively.

NOTE 2 The term `[transition_name]` can only be used in the production for `transition` when feature 7 of table 41 is supported. The resulting production is the textual equivalent of this feature.

B.1.7 Configuration elements

PRODUCTION RULES:

```

configuration_name ::= identifier

resource_type_name ::= identifier

configuration_declaration ::=
    'CONFIGURATION' configuration_name
    [global_var_declarations]
    (single_resource_declaration
     | (resource_declaration {resource_declaration}))
    [access_declarations]
    [instance_specific_initializations]
    'END_CONFIGURATION'

resource_declaration ::=
    'RESOURCE' resource_name 'ON' resource_type_name
    [global_var_declarations]
    single_resource_declaration
    'END_RESOURCE'

single_resource_declaration ::=
    {task_configuration ';' }
    program_configuration ';'
    {program_configuration ';' }

resource_name ::= identifier

access_declarations ::=
    'VAR_ACCESS'
    access_declaration ';'
    {access_declaration ';' }
    'END_VAR'

access_declaration ::= access_name ':' access_path ':'
    non_generic_type_name [direction]

access_path ::= [resource_name '.'] direct_variable
    | [resource_name '.'] [program_name '.']
    {fb_name '.'} symbolic_variable

global_var_reference ::=
    [resource_name '.'] global_var_name ['.' structure_element_name]

access_name ::= identifier

program_output_reference ::= program_name '.' symbolic_variable

```

<http://www.china-gauges.com/>

```

program_name ::= identifier
direction ::= 'READ_WRITE' | 'READ_ONLY'
task_configuration ::= 'TASK' task_name task_initialization
task_name := identifier
task_initialization ::=
    '(' ['SINGLE' ':' data_source ',']
      ['INTERVAL' ':' data_source ',']
      ['PRIORITY' ':' integer ')']
data_source ::= constant | global_var_reference
              | program_output_reference | direct_variable
program_configuration ::=
    'PROGRAM' [RETAIN | NON_RETAIN]
    program_name 'WITH' task_name ':' program_type_name
    ['(' prog_conf_elements ')']
prog_conf_elements ::= prog_conf_element {',' prog_conf_element}
prog_conf_element ::= fb_task | prog_cnxn
fb_task ::= fb_name 'WITH' task_name
prog_cnxn ::= symbolic_variable ':' prog_data_source
            | symbolic_variable '=>' data_sink
prog_data_source ::=
    constant | enumerated_value | global_var_reference | direct_variable
data_sink ::= global_var_reference | direct_variable
instance_specific_initializations ::=
    'VAR_CONFIG'
    instance_specific_init ';'
    {instance_specific_init ';'}
    'END_VAR'
instance_specific_init ::=
    resource_name '.' program_name '.' {fb_name '.'}
    ((variable_name [location] ':' located_var_spec_init) |
     (fb_name ':' function_block_type_name ':'=
      structure_initialization))

```

SEMANTICS: see 2.7.

NOTE This syntax does not reflect the fact that location assignments are only allowed for references to variables which are marked by the asterisk notation at type declaration level.

<http://www.china-gauges.com/>

B.2 Language IL (Instruction List)

B.2.1 Instructions and operands

PRODUCTION RULES:

```

instruction_list ::= il_instruction {il_instruction}
il_instruction ::= [label':'] [ il_simple_operation
    | il_expression
    | il_jump_operation
    | il_fb_call
    | il_formal_func_call
    | il_return_operator ] EOL {EOL}
label ::= identifier
il_simple_operation ::= ( il_simple_operator [il_operand] )
    | ( function_name [il_operand_list] )
il_expression ::= il_expr_operator '(' [il_operand] EOL {EOL}
    [simple_instr_list ] ')'
il_jump_operation ::= il_jump_operator label
il_fb_call ::= il_call_operator fb_name ['('
    (EOL {EOL} [ il_param_list ] ) | [ il_operand_list ] ')']
il_formal_func_call ::= function_name '(' EOL {EOL} [il_param_list] ')'
il_operand ::= constant | variable | enumerated_value
il_operand_list ::= il_operand {',' il_operand}
simple_instr_list ::= il_simple_instruction {il_simple_instruction}
il_simple_instruction ::=
    (il_simple_operation | il_expression | il_formal_func_call)
    EOL {EOL}
il_param_list ::= {il_param_instruction} il_param_last_instruction
il_param_instruction ::= (il_param_assignment | il_param_out_assignment)
    ',' EOL {EOL}
il_param_last_instruction ::=
    ( il_param_assignment | il_param_out_assignment ) EOL {EOL}
il_param_assignment ::= il_assign_operator ( il_operand | ( '(' EOL {EOL}
    simple_instr_list ')' ) )
il_param_out_assignment ::= il_assign_out_operator variable

```

B.2.2 Operators

PRODUCTION RULES:

```

il_simple_operator ::= 'LD' | 'LDN' | 'ST' | 'STN' | 'NOT' | 'S'
    | 'R' | 'S1' | 'R1' | 'CLK' | 'CU' | 'CD' | 'PV'
    | 'IN' | 'PT' | il_expr_operator
il_expr_operator ::= 'AND' | '&' | 'OR' | 'XOR' | 'ANDN' | '&N' | 'ORN'
    | 'XORN' | 'ADD' | 'SUB' | 'MUL' | 'DIV' | 'MOD' | 'GT' | 'GE' | 'EQ'
    | 'LT' | 'LE' | 'NE'

```

<http://www.china-gauges.com/>

```

il_assign_operator ::= variable_name':='
il_assign_out_operator ::= ['NOT'] variable_name'=>'
il_call_operator ::= 'CAL' | 'CALC' | 'CALCN'
il_return_operator ::= 'RET' | 'RETC' | 'RETCN'
il_jump_operator ::= 'JMP' | 'JMPC' | 'JMPCN'

```

SEMANTICS: see 3.2. This syntax does not reflect the possibility for turning IL operators as noted in table 52.

B.3 Language ST (Structured Text)

B.3.1 Expressions

PRODUCTION RULES:

```

expression ::= xor_expression {'OR' xor_expression}
xor_expression ::= and_expression {'XOR' and_expression}
and_expression ::= comparison {'&' | 'AND'} comparison
comparison ::= equ_expression { ('=' | '<>') equ_expression}
equ_expression ::= add_expression {comparison_operator add_expression}
comparison_operator ::= '<' | '>' | '<=' | '>='
add_expression ::= term {add_operator term}
add_operator ::= '+' | '-'
term ::= power_expression {multiply_operator power_expression}
multiply_operator ::= '*' | '/' | 'MOD'
power_expression ::= unary_expression {'**' unary_expression}
unary_expression ::= [unary_operator] primary_expression
unary_operator ::= '-' | 'NOT'
primary_expression ::=
    constant | enumerated_value | variable | '(' expression ')'
    | function_name '(' param_assignment {',' param_assignment} ')'

```

SEMANTICS: these definitions have been arranged to show a top-down derivation of expression structure. The precedence of operations is then implied by a “bottom-up” reading of the definitions of the various kinds of expressions. Further discussion of the semantics of these definitions is given in 3.3.1. See 2.5.1.1 for details of the semantics of function calls.

B.3.2 Statements

PRODUCTION RULE:

```

statement_list ::= statement ';' {statement ';'}
statement ::= NIL | assignment_statement | subprogram_control_statement
    | selection_statement | iteration_statement

```

SEMANTICS: see 3.3.2.

<http://www.china-gauges.com/>

B.3.2.1 Assignment statements

PRODUCTION RULE:

```
assignment_statement ::= variable ':=' expression
```

SEMANTICS: see 3.3.2.1.

B.3.2.2 Subprogram control statements

PRODUCTION RULES:

```
subprogram_control_statement ::= fb_invocation | 'RETURN'
fb_invocation ::= fb_name '(' [param_assignment {',' param_assignment}]
                ')'
param_assignment ::= [variable_name ':='] expression
                  | ([ 'NOT' ] variable_name '=>' variable)
```

SEMANTICS: see 3.3.2.2.

B.3.2.3 Selection statements

PRODUCTION RULES:

```
selection_statement ::= if_statement | case_statement
if_statement ::=
    'IF' expression 'THEN' statement_list
    { 'ELSIF' expression 'THEN' statement_list }
    [ 'ELSE' statement_list ]
    'END_IF'
case_statement ::=
    'CASE' expression 'OF'
    case_element
    { case_element }
    [ 'ELSE' statement_list ]
    'END_CASE'
case_element ::= case_list ':' statement_list
case_list ::= case_list_element { ',' case_list_element }
case_list_element ::= subrange | signed_integer | enumerated_value
```

SEMANTICS: see 3.3.2.3.

B.3.2.4 Iteration statements

PRODUCTION RULES:

```
iteration_statement ::=
    for_statement | while_statement | repeat_statement | exit_statement
for_statement ::=
    'FOR' control_variable ':=' for_list 'DO' statement_list 'END_FOR'
control_variable ::= identifier
for_list ::= expression 'TO' expression [ 'BY' expression ]
while_statement ::= 'WHILE' expression 'DO' statement_list 'END_WHILE'
repeat_statement ::=
    'REPEAT' statement_list 'UNTIL' expression 'END_REPEAT'
exit_statement ::= 'EXIT'
```

SEMANTICS: see 3.3.2.4.

<http://www.china-gauges.com/>

ANNEX C
(normative)
Delimiters and keywords

The usages of delimiters and keywords in this standard is summarized in tables C.1 and C.2. National standards organizations can publish tables of translations for the textual portions of the delimiters listed in table C.1 and the keywords listed in table C.2.

Table C.1 - Delimiters

Delimiters	Subclause	Usage
Space	2.1.4	As specified in 2.1.4.
(* *)	2.1.5	Begin comment End comment
+	2.2.1 3.3.1	Leading sign of decimal literal Addition operator
-	2.2.1 2.2.3.2 3.3.1 4.1.1	Leading sign of decimal literal Year-month-day separator Subtraction, negation operator Horizontal line
#	2.2.1 2.2.3	Based number separator Time literal separator
.	2.2.1 2.4.1.1 2.4.1.2 2.5.2.1	Integer/fraction separator Hierarchical address separator Structure element separator Function block structure separator
e or E	2.2.1	Real exponent delimiter
'	2.2.2	Start and end of character string
\$	2.2.2	Start of special character in strings
2.2.3 - Time literal delimiters, including: T#, D, H, M, S, MS, DATE#, D#, TIME_OF_DAY#, TOD#, DATE_AND_TIME#, DT#		
:	2.2.3.2 2.3.3.1 2.4.2 2.6.2 2.7 2.7 2.7 3.2.1 4.1.2	Time of day separator Type name/specification separator Variable/type separator Step name terminator RESOURCE name/type separator PROGRAM name/type separator Access name/path/type separator Instruction label terminator Network label terminator
:=	2.3.3.1 2.7.1 3.3.2.1	Initialization operator Input connection operator Assignment operator
()	2.3.3.1	Enumeration list delimiters

Table C.1 - Delimiters

Delimiters	Subclause	Usage
()	2.3.3.1	Subrange delimiters
[]	2.4.1.2	Array subscript delimiters
[]	2.4.2	String length delimiters
()	2.4.2	Multiple initialization
()	3.2.2	Instruction List modifier/operator
()	3.3.1	Function arguments
()	3.3.1	Subexpression hierarchy
()	3.3.2.2	Function block input list delimiters
,	2.3.3.1	Enumeration list separator
	2.3.3.2	Initial value separator
	2.4.1	Array subscript separator
	2.4.2	Declared variable separator
	2.5.2.1	Function block initial value separator
	2.5.2.1	Function block input list separator
	3.2.1	Operand list separator
	3.3.1	Function argument list separator
	3.3.2.3	CASE value list separator
;	2.3.3.1	Type declaration separator
	3.3	Statement separator
..	2.3.3.1	Subrange separator
	3.3.2.3	CASE range separator
%	2.4.1.1	Direct representation prefix
=>	2.7.1	Output connection operator
3.3.1 - Infix operators, including: **, NOT, *, /, MOD, +, -, <, >, <= >=, =, <>, &, AND, XOR, OR		
or !	4.1.1	Vertical lines

Table C.2 - Keywords

Keywords	Subclause
ACTION...END_ACTION	2.6.4.1
ARRAY...OF	2.3.3.1
AT	2.4.3
CASE...OF...ELSE...END_CASE	3.3.2.3
CONFIGURATION...END_CONFIGURATION	2.7.1
CONSTANT	2.4.3
Data type names	2.3
EN, ENO	2.5.1.2, 2.5.2.1a
EXIT	3.3.2.4
FALSE	2.2.1
F_EDGE	2.5.2.2
FOR...TO...BY...DO...END_FOR	3.3.2.4

Table C.2 - Keywords

Keywords	Subclause
FUNCTION...END_FUNCTION	2.5.1.3
Function names	2.5.1
FUNCTION_BLOCK...END_FUNCTION_BLOCK	2.5.2.2
Function Block names	2.5.2
IF...THEN...ELSIF...ELSE...END_IF	3.3.2.3
INITIAL_STEP...END_STEP	2.6.2
NOT, MOD, AND, XOR, OR	3.3.1
PROGRAM...WITH...	2.7.1
PROGRAM...END_PROGRAM	2.5.3
R_EDGE	2.5.2.2
READ_ONLY, READ_WRITE	2.7.1
REPEAT...UNTIL...END_REPEAT	3.3.2.4
RESOURCE...ON...END_RESOURCE	2.7.1
RETAIN, NON_RETAIN	2.4.3
RETURN	3.3.2.2
STEP...END_STEP	2.6.2
STRUCT...END_STRUCT	2.3.3.1
TASK	2.7.2
TRANSITION...FROM...TO...END_TRANSITION	2.6.3
TRUE	2.2.1
TYPE...END_TYPE	2.3.3.1
VAR...END_VAR	2.4.3
VAR_INPUT...END_VAR	2.4.3
VAR_OUTPUT...END_VAR	2.4.3
VAR_IN_OUT...END_VAR	2.4.3
VAR_TEMP...END_VAR	2.4.3
VAR_EXTERNAL...END_VAR	2.4.3
VAR_ACCESS...END_VAR	2.7.1
VAR_CONFIG...END_VAR	2.7.1
VAR_GLOBAL...END_VAR	2.7.1
WHILE...DO...END_WHILE	3.3.2.4
WITH	2.7.1

<http://www.china-gauges.com/>

ANNEX D
(normative)
Implementation-dependent parameters

The implementation-dependent parameters defined in this standard, and the primary reference clause for each, are listed in table D.1.

NOTE Other implementation-dependent parameters such as the accuracy, precision and repeatability of timing and execution control features may have significant effects on the portability of programs but are beyond the scope of this part of IEC 61131.

Table D.1 - Implementation-dependent parameters

Subclause	Parameters
2.1.2	Maximum length of identifiers
2.1.5	Maximum comment length
2.1.6	Syntax and semantics of pragmas
2.2.2	Syntax and semantics for the use of the double-quote character when a particular implementation supports feature 4 but not feature 2 of table 5.
2.3.1	Range of values and precision of representation for variables of type <code>TIME</code> , <code>DATE</code> , <code>TIME_OF_DAY</code> and <code>DATE_AND_TIME</code> Precision of representation of seconds in types <code>TIME</code> , <code>TIME_OF_DAY</code> and <code>DATE_AND_TIME</code>
2.3.3.1	Maximum number of enumerated values Maximum number of array subscripts Maximum array size Maximum number of structure elements Maximum structure size Maximum range of subscript values Maximum number of levels of nested structures
2.3.3.2	Default maximum length of <code>STRING</code> and <code>WSTRING</code> variables Maximum allowed length of <code>STRING</code> and <code>WSTRING</code> variables
2.4.1.1	Maximum number of hierarchical levels Logical or physical mapping
2.4.2	Initialization of system inputs
2.4.3	Maximum number of variables per declaration Effect of using <code>AT</code> qualifier in declaration of function block instances Warm start behavior if variable is declared as neither <code>RETAIN</code> nor <code>NON_RETAIN</code>
2.5	Information to determine execution times of program organization units
2.5.1.2	Values of outputs when <code>ENO</code> is <code>FALSE</code>
2.5.1.3	Maximum number of function specifications
2.5.1.5	Maximum number of inputs of extensible functions
2.5.1.5.1	Effects of type conversions on accuracy Error conditions during type conversions
2.5.1.5.2	Accuracy of numerical functions
2.5.1.5.6	Effects of type conversions between time data types and other data types not defined in table 30

Table D.1 - Implementation-dependent parameters

Subclause	Parameters
2.5.2	Maximum number of function block specifications and instantiations
2.5.2.1a	Function block input variable assignment when EN is FALSE
2.5.2.3.3	Pvmin, Pvmax of counters
2.5.2.3.4	Effect of a change in the value of a PT input during a timing operation
2.5.3	Program size limitations
2.6.2	Precision of step elapsed time Maximum number of steps per SFC
2.6.3	Maximum number of transitions per SFC and per step
2.6.4.2	Maximum number of action blocks per step
2.6.4.5	Access to the functional equivalent of the Q or A outputs
2.6.5	Transition clearing time Maximum width of diverge/converge constructs
2.7.1	Contents of RESOURCE libraries
2.7.1	Effect of using READ_WRITE access to function block outputs
2.7.2	Maximum number of tasks Task interval resolution
3.3.1	Maximum length of expressions
3.3.2	Maximum length of statements
3.3.2.3	Maximum number of CASE selections
3.3.2.4	Value of control variable upon termination of FOR loop
4.1.1	Restrictions on network topology
4.1.3	Evaluation order of feedback loops

<http://www.china-gauges.com/>

ANNEX E
(normative)
Error conditions

The error conditions defined in this standard, and the primary reference clause for each, are listed in table E.1. These errors may be detected during preparation of the program for execution or during execution of the program. The manufacturer shall specify the disposition of these errors according to the provisions of subclause 1.5.1 of this part of IEC 61131.

Table E.1 - Error conditions

Subclause	Error conditions
2.1.5	Nested comments
2.3.3.1	Ambiguous enumerated value
2.3.3.1	Value of a variable exceeds the specified subrange
2.4.1.1	Missing configuration of an incomplete address specification ("*" notation)
2.4.3	Attempt by a program organization unit to modify a variable which has been declared <code>CONSTANT</code>
2.4.3	Declaration of a variable as <code>VAR_GLOBAL CONSTANT</code> in a containing element having a contained element in which the same variable is declared <code>VAR_EXTERNAL</code> without the <code>CONSTANT</code> qualifier.
2.5.1	Improper use of directly represented or external variables in functions
2.5.1.1	A <code>VAR_IN_OUT</code> variable is not "properly mapped"
2.5.1.1	Ambiguous value caused by a <code>VAR_IN_OUT</code> connection
2.5.1.5.1	Type conversion errors
2.5.1.5.2	Numerical result exceeds range for data type Division by zero
2.5.1.5.3	<code>N</code> input is less than zero in a bit-shift function
2.5.1.5.4	Mixed input data types to a selection function Selector (<code>K</code>) out of range for <code>MUX</code> function
2.5.1.5.5	Invalid character position specified Result exceeds maximum string length <code>ANY_INT</code> input is less than zero in a string function
2.5.1.5.6	Result exceeds range for data type
2.5.2.2	No value specified for a function block instance used as input variable
2.5.2.2	No value specified for an in-out variable
2.6.2	Zero or more than one initial steps in SFC network User program attempts to modify step state or time
2.6.3	Side effects in evaluation of transition condition
2.6.4.5	Action control contention error
2.6.5	Simultaneously true, non-prioritized transitions in a selection divergence Unsafe or unreachable SFC
2.7.1	Data type conflict in <code>VAR_ACCESS</code>
2.7.2	A task fails to be scheduled or to meet its execution deadline

Table E.1 - Error conditions

Subclause	Error conditions
3.2.2	Numerical result exceeds range for data type Current result and operand not of same data type
3.3.1	Division by zero Numerical result exceeds range for data type Invalid data type for operation
3.3.2.1	Return from function without value assigned
3.3.2.4	Iteration fails to terminate
4.1.1	Same identifier used as connector label and element name
4.1.3	Uninitialized feedback variable

<http://www.china-gauges.com/>

ANNEX F (informative) Examples

F.1 Function WEIGH

Example function WEIGH provides the functions of BCD-to-binary conversion of a gross-weight input from a scale, the binary integer subtraction of a tare weight which has been previously converted and stored in the memory of the programmable controller, and the conversion of the resulting net weight back to BCD form, for example, for an output display. The ENO input is used to indicate that the scale is ready to perform the weighing operation.

The "ENO" output indicates that an appropriate command exists (for example, from an operator pushbutton), the scale is in proper condition for the weight to be read, and each function has a correct result.

A textual form of the declaration of this function is:

```
FUNCTION WEIGH : WORD      (* BCD encoded *)
  VAR_INPUT (* "EN" input is used to indicate "scale ready" *)
    weigh_command : BOOL;
    gross_weight : WORD ; (* BCD encoded *)
    tare_weight : INT ;
  END_VAR
  (* Function Body *)
END_FUNCTION              (* Implicit "ENO" *)
```

The body of function WEIGH in the IL language is:

```

                                LD          weigh_command
                                JMPC        WEIGH_NOW
                                ST          ENO          (* No weighing, 0 to "ENO" *)
                                RET
WEIGH_NOW:
                                LD          gross_weight
                                BCD_TO_INT
                                SUB        tare_weight
                                INT_TO_BCD          (* Return evaluated weight *)
                                ST          WEIGH
```

The body of function WEIGH in the ST language is:

```
IF weigh_command THEN
  WEIGH := INT_TO_BCD (BCD_TO_INT(gross_weight) - tare_weight);
END_IF ;
```

<http://www.china-gauges.com/>

An equivalent graphical declaration of function WEIGH is:

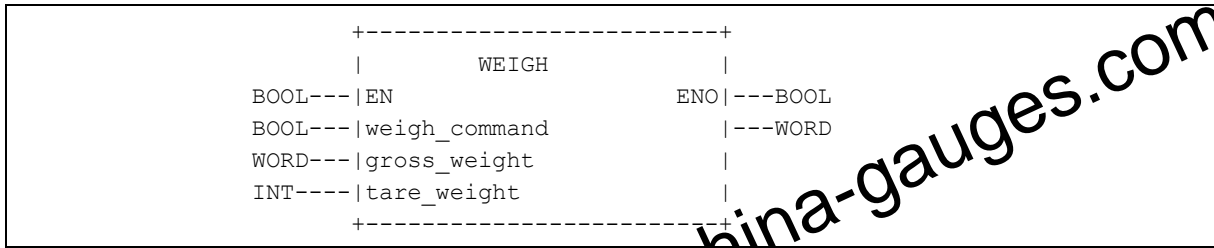

The function body in the LD language is:

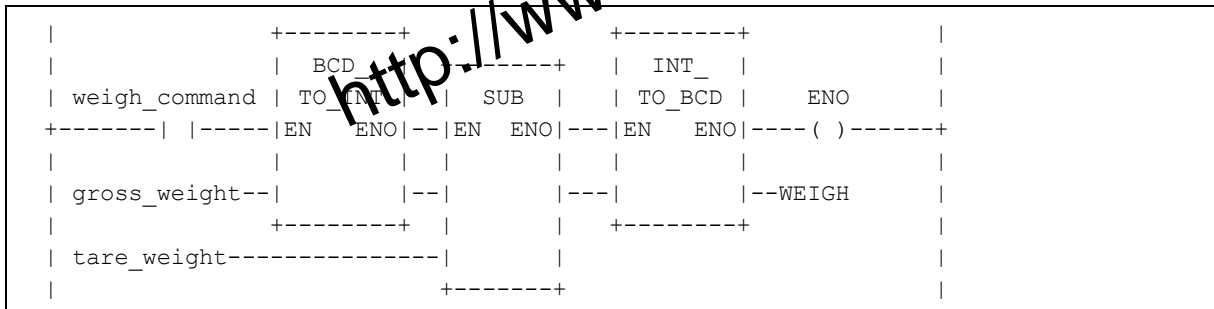

The function body in the FBD language is:

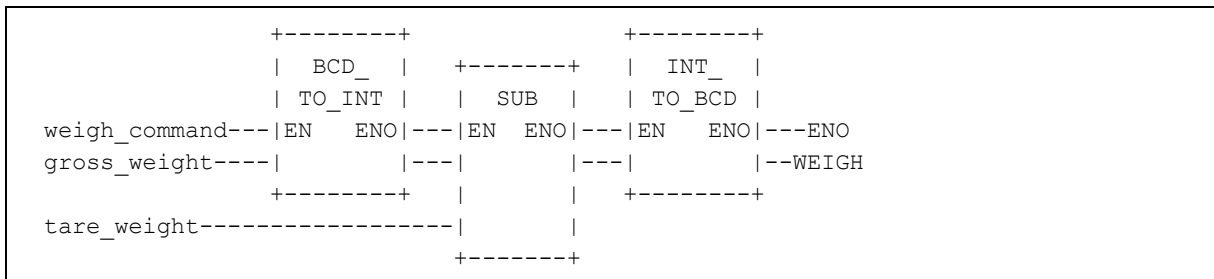

F.2 Function block CMD_MONITOR

Example function block CMD_MONITOR illustrates the control of an operative unit which is capable of responding to a Boolean command (the CMD output) and returning a Boolean feedback signal (the FDBK input) indicating successful completion of the commanded action. The function block provides for manual control via the MAN_CMD input, or automated control via the AUTO_CMD input, depending on the state of the AUTO_MODE input (0 or 1 respectively). Verification of the MAN_CMD input is provided via the MAN_CMD_CHK input, which must be 0 in order to enable the MAN_CMD input.

If confirmation of command completion is not received on the FDBK input within a predetermined time specified by the T_CMD_MAX input, the command is cancelled and an alarm condition is signalled via the ALRM output. The alarm condition may be cancelled by the ACK (acknowledge) input, enabling further operation of the command cycle.

http://www.china-gauges.com/

A textual form of the declaration of function block CMD_MONITOR is:

```

FUNCTION_BLOCK CMD_MONITOR
  VAR_INPUT AUTO_CMD : BOOL ; (* Automated command *)
            AUTO_MODE : BOOL ; (* AUTO_CMD enable *)
            MAN_CMD : BOOL ; (* Manual Command *)
            MAN_CMD_CHK : BOOL ; (* Negated MAN_CMD to debounce *)
            T_CMD_MAX : TIME ; (* Max time from CMD to FDBK *)
            FDBK : BOOL ; (* Confirmation of CMD completion
                           by operative unit *)
            ACK : BOOL ; (* Acknowledge/Cancel ALRM *)

  END_VAR
  VAR_OUTPUT CMD : BOOL ; (* Command to operative unit *)
            ALRM : BOOL ; (* Alarm when T_CMD_MAX expired without FDBK *)

  END_VAR
  VAR CMD_TMR : TON ; (* CMD-to-FDBK timer *)
            ALRM_FF : SR ; (* Note over-riding S input: *)
  END_VAR
  (* Command must be cancelled before
   "ACK" can cancel alarm *)

(* Function Block Body *)
END_FUNCTION_BLOCK

```

An equivalent graphical declaration is:

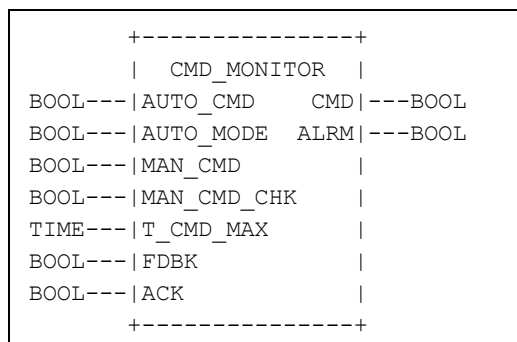

The body of function block CMD_MONITOR in the ST language is:

```

CMD := AUTO_CMD & AUTO_MODE
      OR MAN_CMD & NOT MAN_CMD_CHK & NOT AUTO_MODE ;
CMD_TMR (IN := CMD, PT := T_CMD_MAX);
ALRM_FF (S1 := CMD_TMR.Q & NOT FDBK, R := ACK);
ALRM := ALRM_FF.Q1;

```

The body of function block CMD_MONITOR in the IL language is:

```

LD      T_CMD_MAX
ST      CMD_TMR.PT      (* Store an input to the TON FB *)
LD      AUTO_CMD
AND     AUTO_MODE
OR(     MAN_CMD
ANDN    AUTO_MODE
ANDN    MAN_CMD_CHK
)
ST      CMD
IN      CMD_TMR        (* Invoke the TON FB *)
LD      CMD_TMR.Q
ANDN    FDBK
ST      ALRM_FF.S1     (* Store an input to the SR FB *)
LD      ACK
R       ALRM_FF        (* Invoke the SR FB *)
LD      ALRM_FF.Q1
ST      ALRM
    
```

The body of function block CMD_MONITOR in the LD language is:

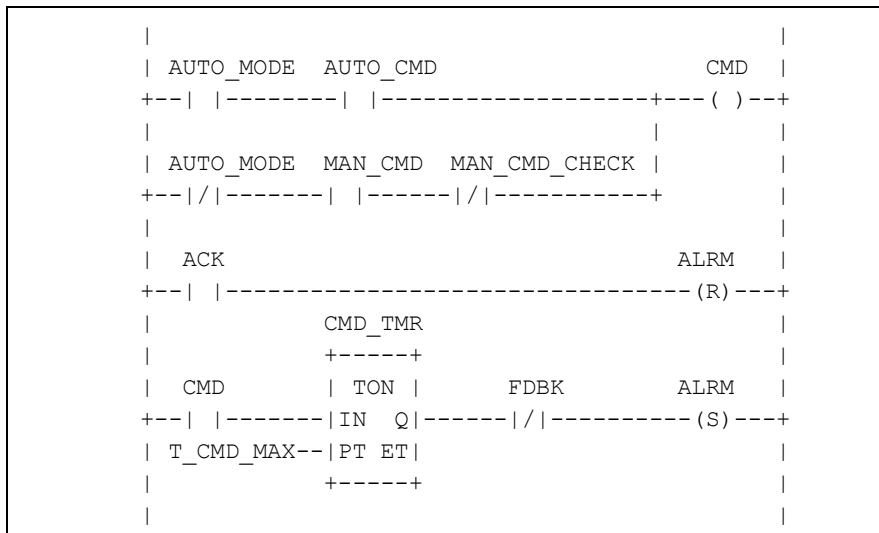

The body of function block CMD_MONITOR in the FBD language is:

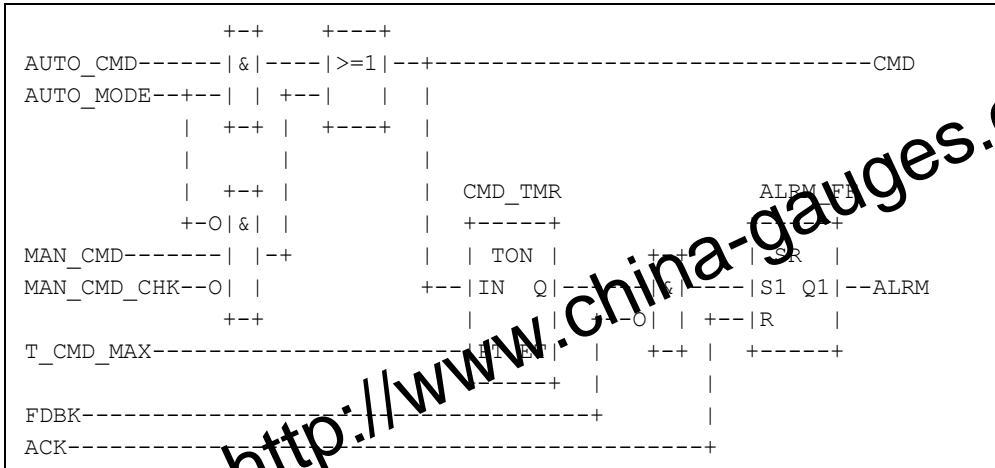

F.3 Function block FWD_REV_MON

Example function block FWD_REV_MON illustrates the control of an operative unit capable of two-way positioning action, for example, a motor-operated valve. Both automated and manual control modes are possible, with alarm capabilities provided for each direction of motion, as described for function block CMD_MONITOR above. In addition, contention between forward and reverse commands causes the cancellation of both commands and signalling of an alarm condition. The Boolean OR of all alarm conditions is made available as a KLAXON output for operator signaling.

A graphical declaration of this function block is:

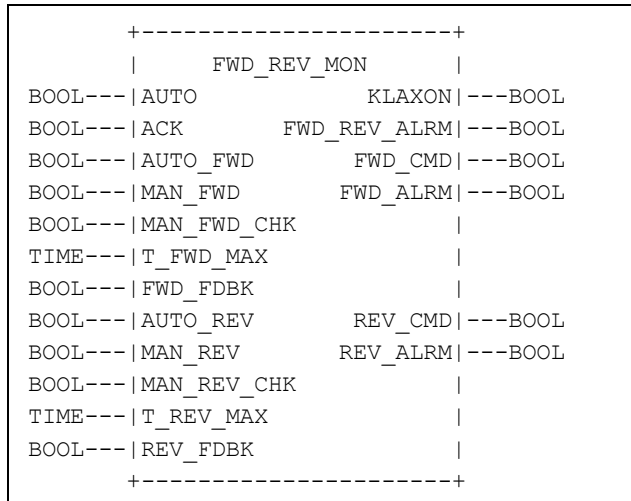

A textual form of the declaration of function block FWD_REV_MON is:

```

FUNCTION_BLOCK FWD_REV_MON
VAR_INPUT AUTO : BOOL ; (* Enable automated commands *)
  ACK : BOOL ;          (* Acknowledge/cancel all alarms *)
  AUTO_FWD : BOOL ;    (* Automated forward command *)
  MAN_FWD : BOOL ;     (* Manual forward command *)
  MAN_FWD_CHK : BOOL ; (* Negated MAN_FWD for debouncing *)
  T_FWD_MAX : TIME ;   (* Maximum time from FWD_CMD to FWD_FDBK *)
  FWD_FDBK : BOOL ;    (* Confirmation of FWD_CMD completion *)
                        (* by operative unit *)
  AUTO_REV : BOOL ;    (* Automated reverse command *)
  MAN_REV : BOOL ;     (* Manual reverse command *)
  MAN_REV_CHK : BOOL ; (* Negated MAN_REV for debouncing *)
  T_REV_MAX : TIME ;   (* Maximum time from REV_CMD to REV_FDBK *)
  REV_FDBK : BOOL ;    (* Confirmation of REV_CMD completion *)
                        (* by operative unit *)
END_VAR
VAR_OUTPUT KLAXON : BOOL ;          (* Any alarm active *)
  FWD_REV_ALARM : BOOL; (* Forward/reverse command conflict *)
  FWD_CMD : BOOL ;      (* "Forward" command to operative unit *)
  FWD_ALARM : BOOL ;    (* T_FWD_MAX expired without FWD_FDBK *)
  REV_CMD : BOOL ;      (* "Reverse" command to operative unit *)
  REV_ALARM : BOOL ;    (* T_REV_MAX expired without REV_FDBK *)
END_VAR
VAR FWD_MON : CMD_MONITOR; (* "Forward" command monitor *)
  REV_MON : CMD_MONITOR;   (* "Reverse" command monitor *)
  FWD_REV_FF : SR ;        (* Forward/Reverse contention latch *)
END_VAR
(* Function Block body *)
END_FUNCTION_BLOCK

```

The body of function block FWD_REV_MON can be written in the ST language as:

```

(* Evaluate internal function blocks *)
FWD_MON (AUTO_MODE := AUTO,
        ACK := ACK,
        AUTO_CMD := AUTO_FWD,
        MAN_CMD := MAN_FWD,
        MAN_CMD_CHK := MAN_FWD_CHK,
        T_CMD_MAX := T_FWD_MAX,
        FDBK := FWD_FDBK);
REV_MON (AUTO_MODE := AUTO,
        ACK := ACK,
        AUTO_CMD := AUTO_REV,
        MAN_CMD := MAN_REV,
        MAN_CMD_CHK := MAN_REV_CHK,
        T_CMD_MAX := T_REV_MAX,
        FDBK := REV_FDBK);
FWD_REV_FF (S1 := FWD_MON.CMD & REV_MON.CMD, R := ACK);
(* Transfer data to outputs *)
FWD_REV_ALARM := FWD_REV_FF.Q1;
FWD_CMD := FWD_MON.CMD & NOT FWD_REV_ALARM;
FWD_ALARM := FWD_MON.ALARM;
REV_CMD := REV_MON.CMD & NOT FWD_REV_ALARM;
REV_ALARM := REV_MON.ALARM;
KLAXON := FWD_ALARM OR REV_ALARM OR FWD_REV_ALARM;

```

The body of function block FWD_REV_MON in the IL language is:

```
(* Evaluate internal function blocks *)
CAL  FWD_MON (
    AUTO_MODE:= AUTO,
    ACK:= ACK,
    AUTO_CMD:= AUTO_FWD,
    MAN_CMD:= MAN_FWD,
    MAN_CMD_CHK:= MAN_FWD_CHK,
    T_CMD_MAX:= T_FWD_MAX,
    FDBK:= FWD_FDBK
)
CAL  REV_MON (
    AUTO_MODE:= AUTO,
    ACK:= ACK,
    AUTO_CMD:= AUTO_REV,
    MAN_CMD:= MAN_REV,
    MAN_CMD_CHK:= MAN_REV_CHK,
    T_CMD_MAX:= T_REV_MAX,
    FDBK:= REV_FDBK
)
CAL  FWD_REV_FF (
    S1:= (
        LD FWD_MON.CMD
        AND REV_MON.CMD
    ),
    R:= ACK,
    Q => FWD_REV_ALARM (* Contention alarm *)
)
(* Transfer data to outputs *)
LD  FWD_MON.CMD (* "Forward" command and alarm *)
ANDN FWD_REV_ALARM
ST  FWD_CMD
LD  FWD_MON.ALARM
ST  FWD_ALARM
LD  REV_MON.CMD (* "Reverse" command and alarm *)
ANDN FWD_REV_ALARM
ST  REV_CMD
LD  REV_MON.ALARM
ST  REV_ALARM
OR  FWD_ALARM (* OR all alarms *)
OR  FWD_REV_ALARM
ST  KLAXON
```

<http://www.china-gauges.com/>

The body of function block FWD_REV_MON in the FBD language is:

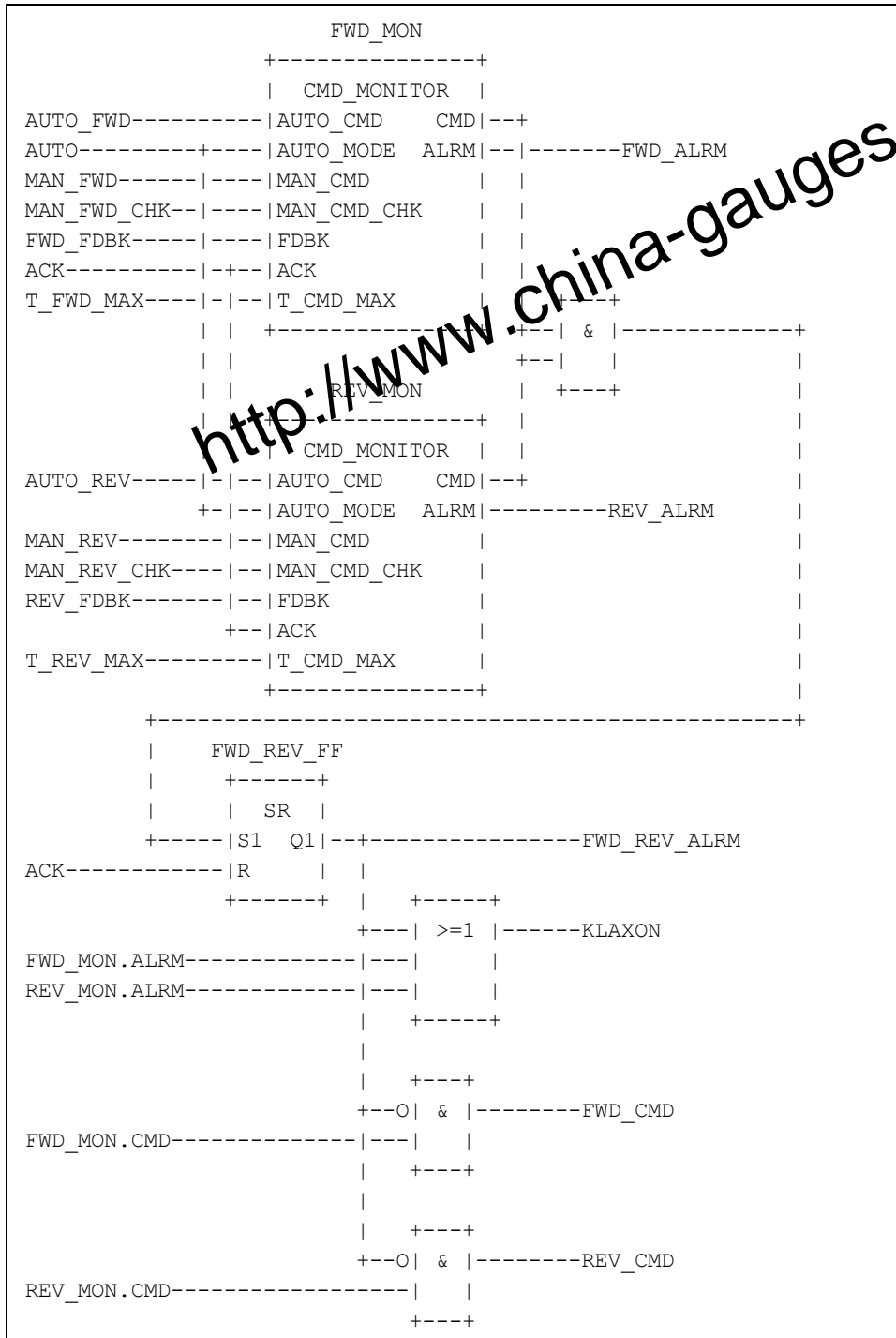

<http://www.china-gauges.com/>

The body of function block FWD_REV_MON in the LD language is:

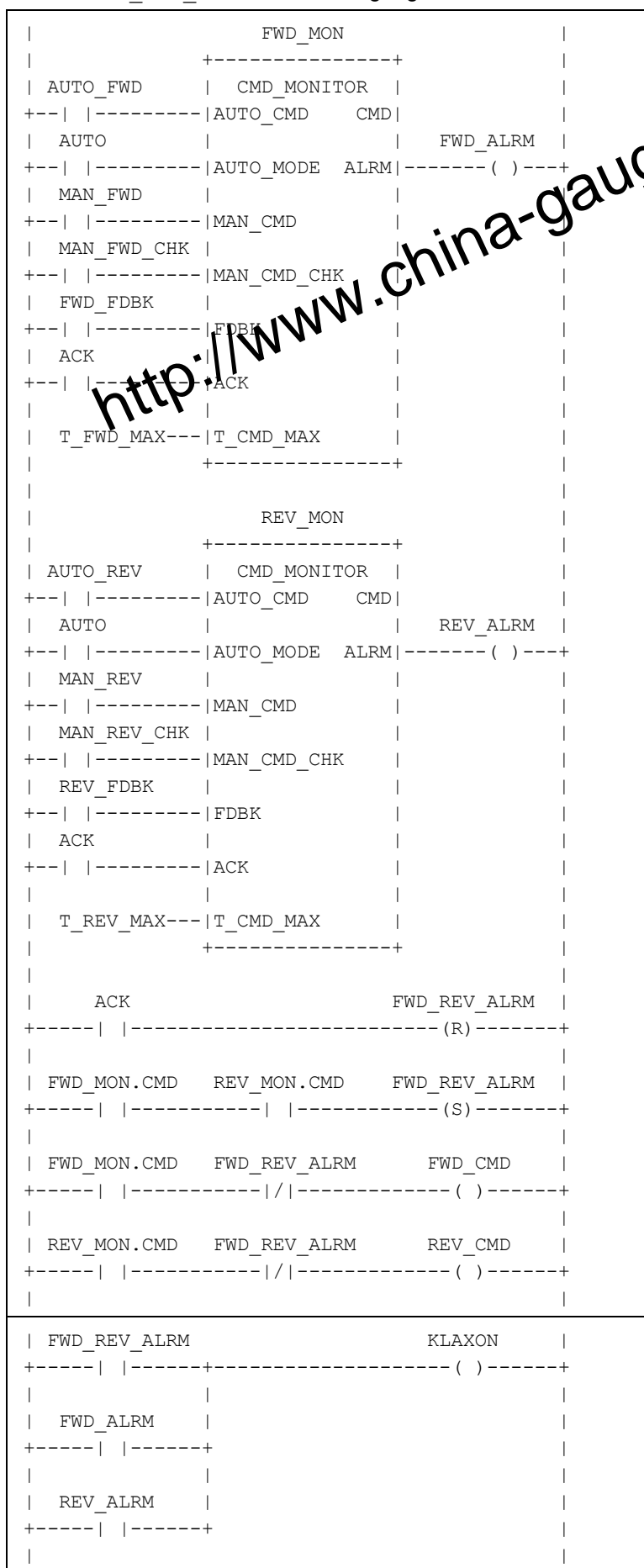

<http://www.china-gauges.com/>

F.4 Function block `STACK_INT`

This function block provides a stack of up to 128 integers. The usual stack operations of `PUSH` and `POP` are provided by edge-triggered Boolean inputs. An overriding reset (`R1`) input is provided; the maximum stack depth (`N`) is determined at the time of resetting. In addition to the top-of-stack data (`OUT`), Boolean outputs are provided indicating stack empty and stack overflow states.

A textual form of the declaration of this function block is:

```

FUNCTION_BLOCK STACK_INT
  VAR_INPUT PUSH, POP: BOOL R_EDGE; (* Basic stack operations *)
           R1 : BOOL ;                (* Overriding reset *)
           IN : INT ;                 (* Input to be pushed *)
           N  : INT ;                 (* Maximum depth after reset *)

  END_VAR

  VAR_OUTPUT EMPTY : BOOL := 1 ;      (* Stack empty *)
           OFLO  : BOOL := 0 ;      (* Stack overflow *)
           OUT   : INT  := 0 ;      (* Top of stack data *)

  END_VAR

  VAR STK : ARRAY[0..127] OF INT; (* Internal stack *)
      NI  : INT :=128 ;           (* Storage for N upon reset *)
      PTR : INT := -1 ;           (* Stack pointer *)

  END_VAR

  (* Function Block body *)
END_FUNCTION_BLOCK

```

A graphical declaration of function block `STACK_INT` is:

```

          +-----+
          | STACK_INT |
          +-----+
          |
          | BOOL--->PUSH  EMPTY|---BOOL
          | BOOL--->POP   OFLO |---BOOL
          | BOOL---|R1    OUT |---INT
          | INT----|IN      |
          | INT----|N      |
          |
          +-----+

(* Internal variable declarations *)
VAR STK : ARRAY[0..127] OF INT ; (* Internal Stack *)
    NI  : INT :=128 ;           (* Storage for N upon Reset *)
    PTR : INT := -1 ;           (* Stack Pointer *)
END_VAR

```

The body of function block STACK_INT in the ST language is:

```

IF R1 THEN
  OFLO := 0; EMPTY := 1; PTR := -1;
  NI := LIMIT (MN:=1,IN:=N,MX:=128); OUT := 0;
ELSIF POP & NOT EMPTY THEN
  OFLO := 0; PTR := PTR-1; EMPTY := PTR = 0;
  IF EMPTY THEN OUT := 0;
  ELSE OUT := STK[PTR];
  END_IF ;
ELSIF PUSH & NOT OFLO THEN
  EMPTY := 0; PTR := PTR+1; OFLO := (PTR = NI);
  IF NOT OFLO THEN OUT := IN ; STK[PTR] := IN;
  ELSE OUT := 0;
  END_IF ;
END_IF ;

```

The body of function block STACK_INT in the LD language is:

```

|
|   R1
+---| |--->>RESET
|
|   POP  EMPTY
+---| |---|/|--->>POP_STK
|
|   PUSH  OFLO
+---| |---|/|--->>PUSH_STK
|
|
+-----<RETURN>
|
RESET:
|   +-----+           +-----+           +-----+           |
|   | MOVE |           | MOVE |           | LIMIT |           OFLO |
+-----|EN  ENO|-----|EN  ENO|-----|EN  ENO|----- (R) ---+
| 0---|           |--OUT -1 --|           |--PTR 128--|MX   |   | EMPTY |
|   +-----+           +-----+           N--|IN   |   +---- (S) ---+
|                                           1--|MN   |--NI   |
|                                           +-----+           |
+-----<RETURN>

```

<http://www.china-gauges.com/>

```

POP_STK:
|          +-----+          +-----+          |
|          | SUB  |          | LT  |          |
+-----+ | EN  ENO|-----+ | EN  ENO|  EMPTY |
| PTR--|          |--PTR--|          |----(S)----+
| 1--|          | 0--|          |          |
|          +-----+          +-----+          |
|          |          |          |          |
|          | SEL  |          | OFLO |          |
+-----+ | EN  ENO|-----+ | EN  ENO|  EMPTY |
| EMPTY |          |          |          |
+---+ | |-----+ |G          |---OUT |
| STK[PTR]---| IN0 |          |          |
| 0 ---| IN1 |          |          |
|          +-----+          +-----+          |
+-----+-----<RETURN>-----+

PUSH_STK:
|          +-----+          +-----+          |
|          | ADD  |          | EQ  |          |
+-----+ | EN  ENO|-----+ | EN  ENO|  OFLO  |
| PTR--|          |--PTR--|          |----(S)----+
| 1--|          | NI--|          |          |
|          +-----+          +-----+          |
|          |          |          |          |
| OFLO  | MOVE |          |          |
+---+ / |-----+ | EN  ENO|-----+ | EN  ENO|  OFLO |
| IN---|          |---STK[PTR] |          |
|          +-----+          +-----+          |
|          |          |          |          |
|          | SEL  |          | EMPTY |          |
+-----+ | EN  ENO|-----+ | EN  ENO|  (R)----+
| OFLO  |          |          |          |
+---+ | |-----+ |G          |---OUT |
| IN---| IN0 |          |          |
| 0 ---| IN1 |          |          |
|          +-----+          +-----+          |

```

<http://www.china-gauges.com/>

The body of function block STACK_INT in the IL language is:

```

LD      R1          (* Dispatch on operations *)
JMPC   RESET
LD      POP
ANDN   EMPTY       (* Don't pop empty stack *)
JMPC   POP_STK
LD      PUSH
ANDN   OFLO        (* Don't push overflowed stack *)
JMPC   PUSH_STK
RET                                (* Return if no operations active *)
RESET: LD      0          (* Stack reset operations *)
      ST      OFLO
      LD      -1
      ST      PTR
      LD      1
      LIMIT   N, 128
      ST      NI
      JMP     ZRO_OUT
POP_STK: LD      0
      ST      OFLO       (* Popped stack is not overflowing *)
      LD      PTR
      SUB     1
      ST      PTR
      LT      0          (* Empty when PTR < 0 *)
      ST      EMPTY
      JMPC   ZRO_OUT
      LD      STK[PTR]
      JMP     SET_OUT
PUSH_STK: LD      0
      ST      EMPTY     (* Pushed stack is not empty *)
      LD      PTR
      ADD     1
      ST      PTR
      EQ     NI          (* Overflow when PTR = NI *)
      ST      OFLO
      JMPC   ZRO_OUT
      LD      IN
      ST      STK[PTR]  (* Push IN onto STK *)
      JMP     SET_OUT
ZRO_OUT: LD      0          (* OUT=0 for EMPTY or OFLO *)
SET_OUT: ST      OUT

```

<http://www.china-gauges.com/>

The body of function block STACK_INT in the FBD language is:

```

R1---+--->>RESET
      |
      |                                     +-+
      +-----O|&|---<RETURN>
      |   +-+ +-----O| |
      +--O|&| |   +--O| |
POP----| |---+--->>POP_STK      |   +-+
EMPTY--O| | |   +-+ |
      +-+ +-----O|&|---+--->>PUSH_STK
R1-----O| |
PUSH-----| |
OFLO-----O| |
      +-+

RESET:
      +-----+           +-----+           +-----+
      | := |           | := |           | := |
1 --|EN ENO|-----|EN ENO|-----|EN ENO|---+
0 --|   |---OUT -1 --|   |---PTR 0--|   |---OFLO
      +-----+           +-----+           +-----+
      |
      +-----+
      | +-----+           +-----+
      | | := |           | LIMIT |
      +--|EN ENO|-----|EN ENO|---<RETURN>
      1--|   |---EMPTY 128--|MX |
      +-----+           N--|IN |---NI
      |           1--|MN |
      +-----+

POP_STK:
      +-----+           +-----+           +-----+           +-----+
      | - |           | < |           | SEL |           | := |
1----|EN ENO|-----|EN ENO|-----|EN ENO|-----|EN ENO|---<RETURN>
--PTR|   |---PTR--|   |---EMPTY--|G |---+ |
----1|   | 0 --|   | +-----|IN0 | | 0--|   |---OFLO
      +-----+           +-----+ | +-----|IN1 | | +-----+
STK[PTR]-----+ | +-----+ |
0-----+ +-----OUT

PUSH_STK:
      +-----+           +-----+           +-----+
      | := |           | + |           | = |
1--|EN ENO|-----|EN ENO|-----|EN ENO|---
0--|   |---EMPTY 1--|   |---PTR--|G |---+---OFLO
      +-----+           +---|   | NI---| |
PTR-----+ +-----+ +-----+ |
      |
      +-----+
      | +-----+           | +-----+
      | | := |           | | SEL |
      +---|EN ENO|           +---|G |-----OUT
IN--+-----|   |---STK[PTR] +-----|IN0 |
      | +-----+           | 0---|IN1 |
      +-----+           +-----+
  
```

<http://www.china-gauges.com/>

F.5 Function block MIX_2_BRIX

Function block MIX_2_BRIX is to control the mixing of two bricks of solid material, brought one at a time on a belt, with weighed quantities of two liquid components, A and B, as shown in figure F.1. A "Start" (ST) command, which may be manual or automatic, initiates a measurement and mixing cycle beginning with simultaneous weighing and brick transport as follows:

- liquid A is weighed up to mark "a" of the weighing unit, then liquid B is weighed up to mark "b", followed by filling of the mixer from weighing unit C;
- two bricks are transported by belt into the mixer.

The cycle ends with the mixer rotating and finally tipping after a predetermined time "t1". Rotation of the mixer continues while it is emptying.

The scale reading "WC" is given as four BCD digits, and will be converted to type INT for internal operations. It is assumed that the tare (empty weight) "z" has been previously determined.

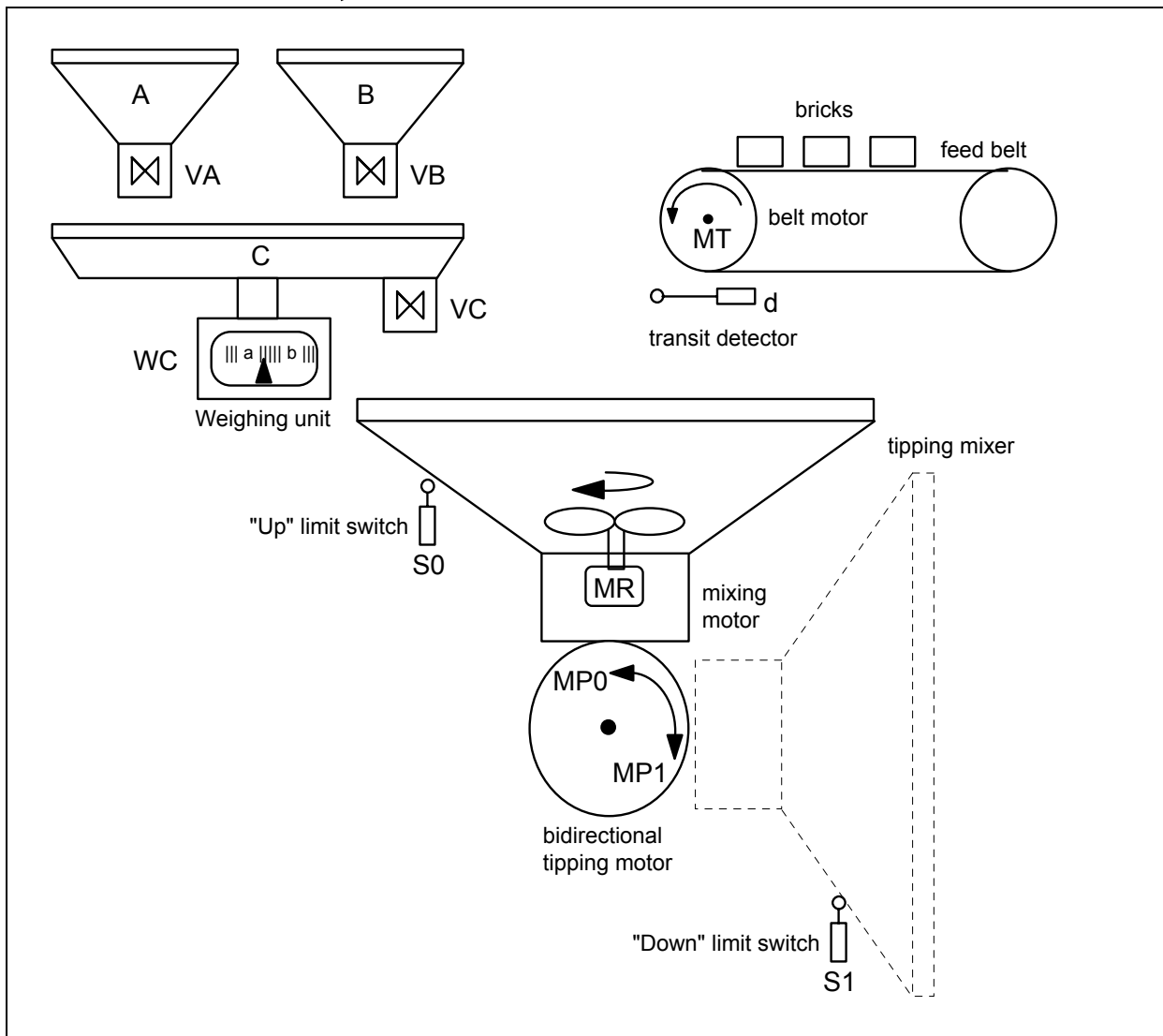
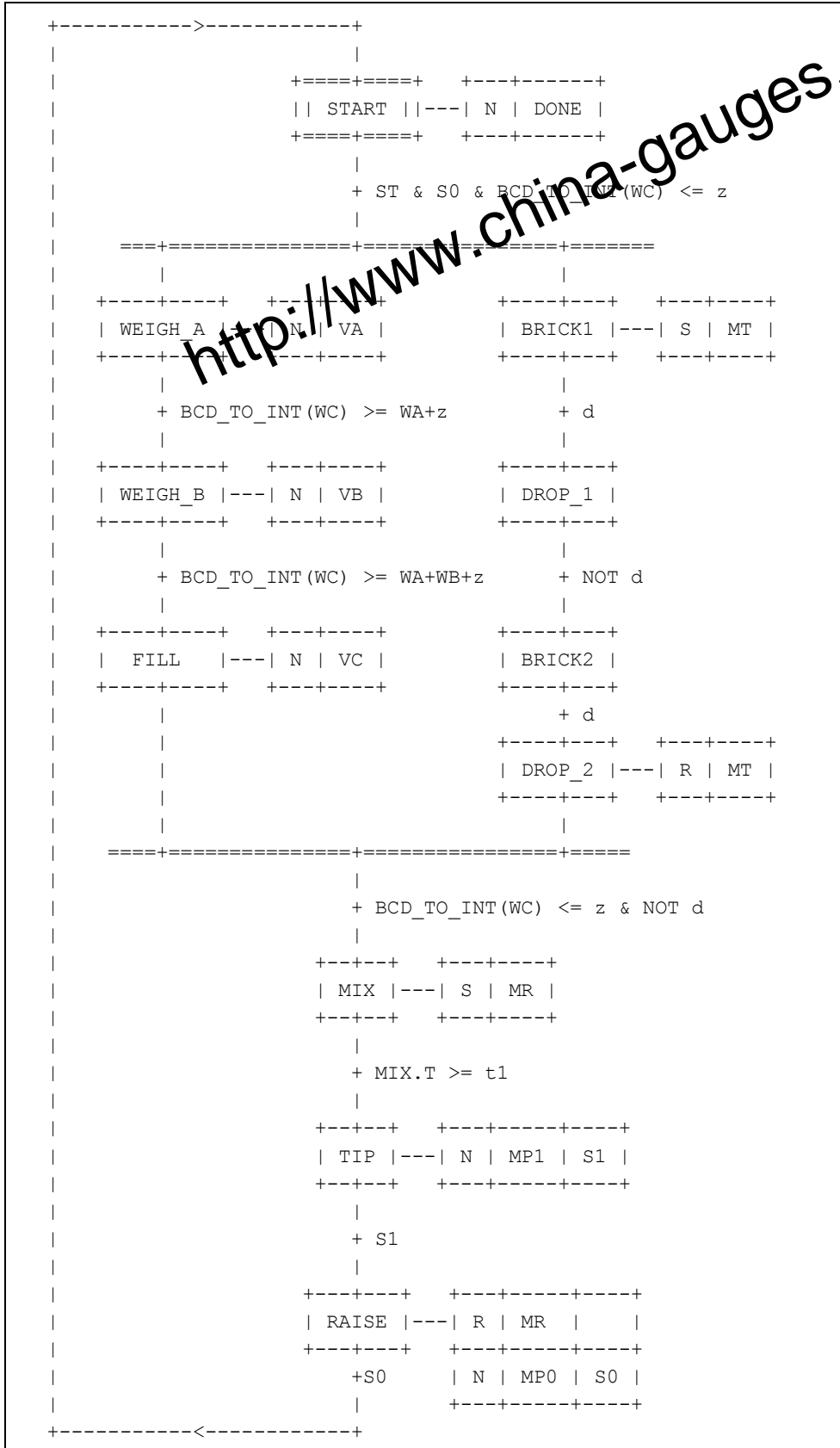

Figure F.1 - Function block MIX_2_BRIX - physical model

The body of function block MIX_2_BRIX using graphical SFC elements with transition conditions in the ST language is shown below.



<http://www.china-gauges.com/>

The body of function block MIX_2_BRIX in a textual SFC representation using ST language elements is:

```

INITIAL_STEP START: DONE(N); END_STEP

TRANSITION FROM START TO (WEIGH_A, BRICK1)
    := ST & S0 & BCD_TO_INT(WC) <= z;
END_TRANSITION

STEP WEIGH_A: VA(N); END_STEP
TRANSITION FROM WEIGH_A TO WEIGH_B := BCD_TO_INT(WC) >= WA+z ;
END_TRANSITION

STEP WEIGH_B: VB(N); END_STEP
TRANSITION FROM WEIGH_B TO FILL := BCD_TO_INT(WC) >= WA+WB+z ;
END_TRANSITION

STEP FILL: VC(N); END_STEP
STEP BRICK1: MT(S); END_STEP
TRANSITION FROM BRICK1 TO DROP_1 := d ; END_TRANSITION

STEP DROP_1: END_STEP
TRANSITION FROM DROP_1 TO BRICK2 := NOT d ; END_TRANSITION

STEP BRICK2: END_STEP
TRANSITION FROM BRICK2 TO DROP_2 := d ; END_TRANSITION

STEP DROP_2: MT(R); END_STEP

TRANSITION FROM (FILL, DROP_2) TO MIX
    := BCD_TO_INT(WC) <= z & NOT d ;
END_TRANSITION

STEP MIX: MR(S); END_STEP
TRANSITION FROM MIX TO TIP := MIX.T >= t1 ; END_TRANSITION

STEP TIP: MP1(N); END_STEP
TRANSITION FROM TIP TO RAISE := S1 ; END_TRANSITION

STEP RAISE: MR(R); MP0(N); END_STEP
TRANSITION FROM RAISE TO START := S0 ; END_TRANSITION

```

F.6 Analog signal processing

The purpose of this portion of of this annex is to illustrate the application of the programming languages defined in this standard to accomplish the basic measurement and control functions of process-computer aided automation. The blocks shown below are not restricted to analog signals; they may be used to process any variables of the appropriate types. Similarly, other functions and function blocks defined in this standard (for example, mathematical functions) can be used for the processing of variables which may appear as analog signals at the programmable controller's I/O terminals.

These function blocks can be typed with respect to the input and output variables shown below as REAL (for example, XIN, XOUT) by appending the appropriate data type name, for example, LAG1_LREAL. The default data type for these variables is REAL.

These examples are given for illustrative purposes only. Manufacturers may have varying implementations of analog signal processing elements. The inclusion of these examples is not intended to preclude the standardization of such elements by the appropriate standards bodies.

F.6.1 Function block LAG1

This function block implements a first-order lag filter.



F.6.2 Function block DELAY

This function block implements an N-sample delay.

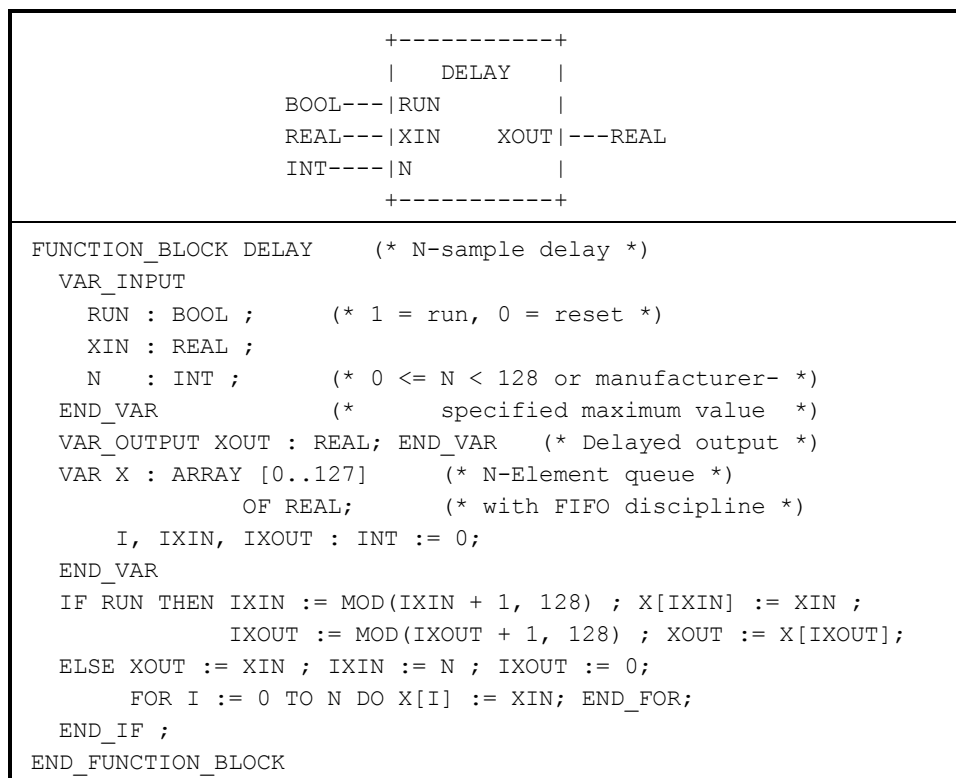

F.6.3 Function block AVERAGE

This function block implements a running average over N samples.

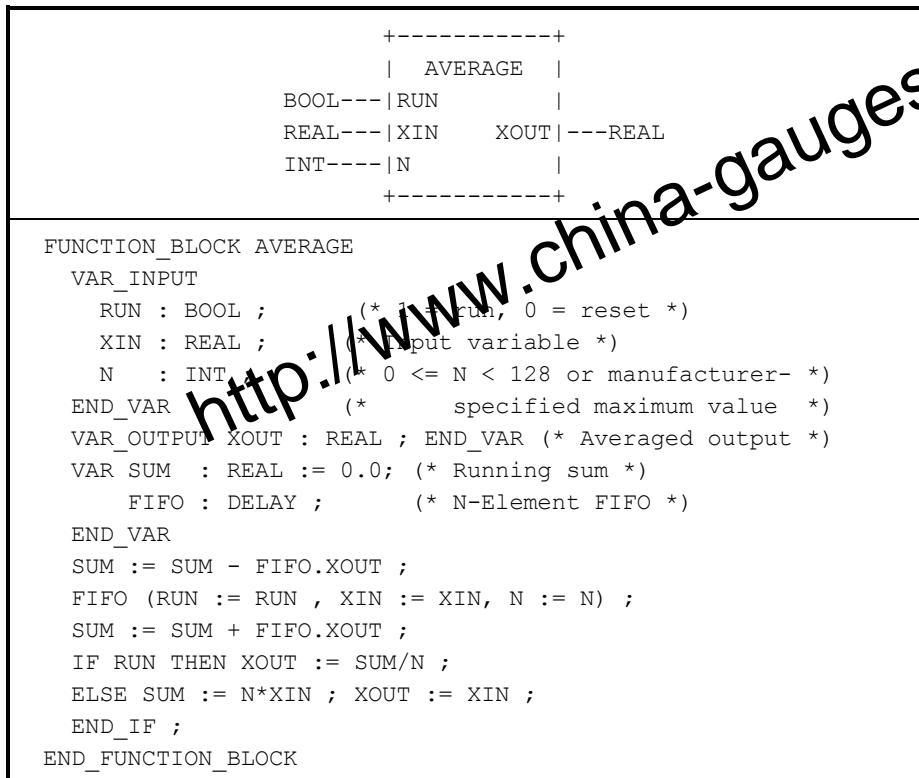

F.6.4 Function block INTEGRAL

This function block implements integration over time.

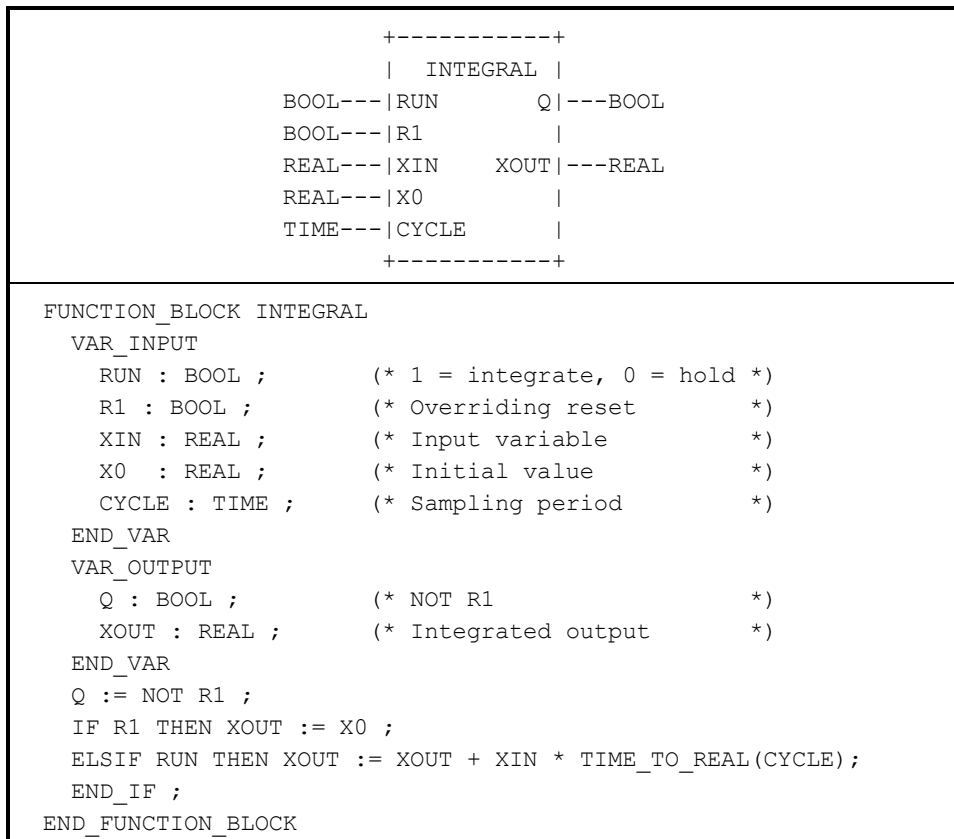

F.6.5 Function block DERIVATIVE

This function block implements differentiation with respect to time.

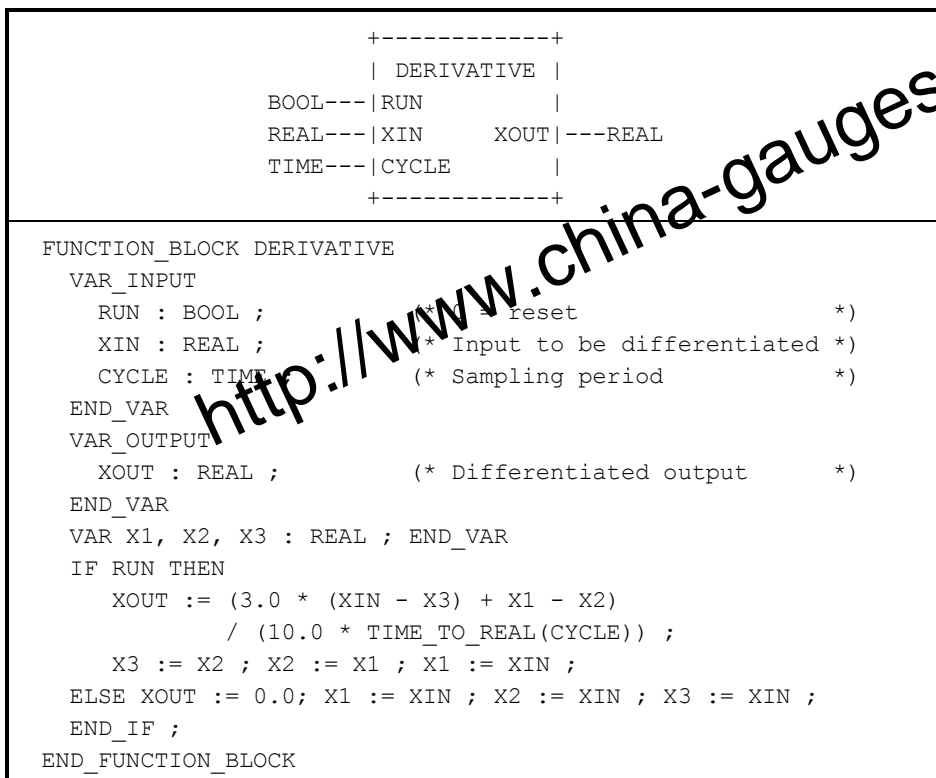

F.6.6 Function block HYSTERESIS

This function block implements Boolean hysteresis on the difference of REAL inputs.

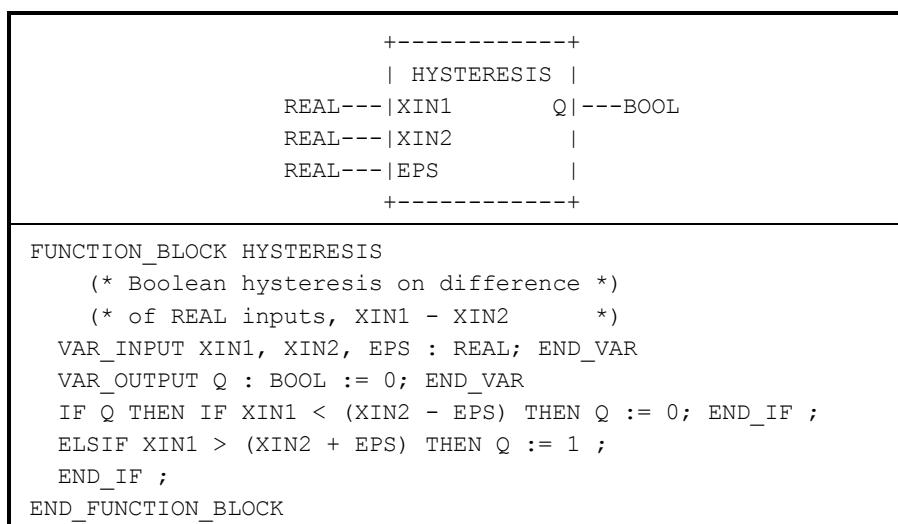

<http://www.china-gauges.com/>

F.6.9 Function block ANALOG_MONITOR

This function block implements analog signal monitoring.

```

+-----+
| ANALOG_ |
| MONITOR |
+-----+
REAL--X   SE|--BOOL (* Signal error *)
ANALOG_LIMITS--L   ME|--BOOL (* Measurement error *)
|         ALRM|--BOOL (* Alarm *)
|         WARN|--BOOL (* Warning *)
|         QH|--BOOL (* QH = Signal high *)
+-----+

(* Function block body in STL language *)

      SIGNAL_ALARM          MEAS_ALARM
+-----+                  +-----+
| LIMITS_ALARM |          | LIMITS_ALARM |
L.HS---|H           Q|---SE  L.HM---|H           Q|---ME
X-----|X           |          X-----|X           |
L.LS---|L           |          L.LM---|L           |
EPS----|EPS        |          EPS----|EPS        |
+-----+                  +-----+

      ALARM                  WARNING
+-----+                  +-----+
| LIMITS_ALARM |          | LIMITS_ALARM |
L.HA---|H           Q|---ALRM L.HW---|H           Q|---WARN
X-----|X           |          X---|X           |
L.LA---|L           |          L.LW---|L           |
EPS----|EPS        |          EPS---|EPS        |
+-----+                  +-----+

+-----+
SIGNAL_ALARM.QH---| >= 1 |---QH
MEAS_ALARM.QH-----|      |
ALARM.QH-----|      |
WARNING.QH-----|      |
+-----+

```

<http://www.china-gauges.com/>

F.6.10 Function block PID

This function block implements Proportional + Integral + Derivative control action. The functionality is derived by functional composition of previously declared function blocks.

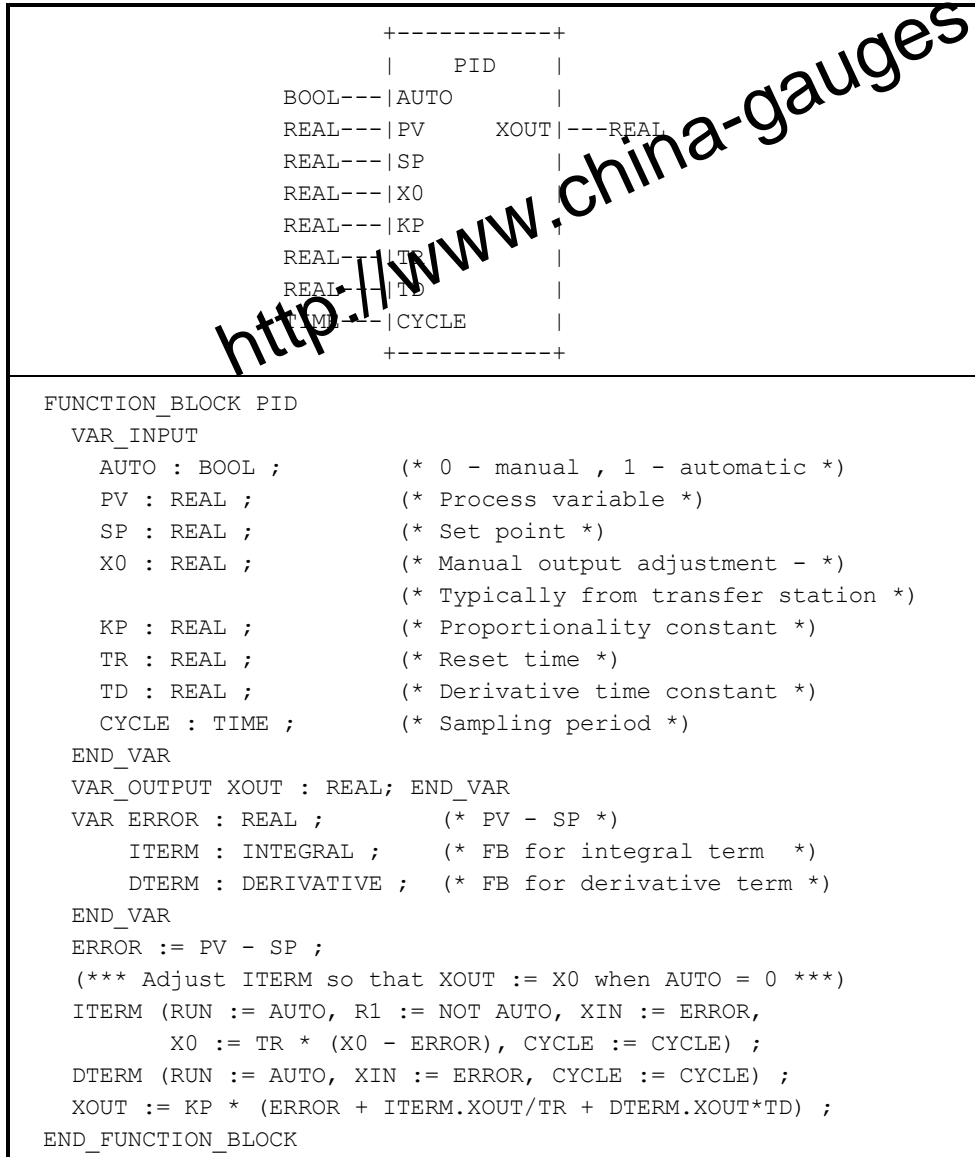

<http://www.china-gauges.com/>

F.6.11 Function block DIFFEQ

This function block implements a general difference equation.

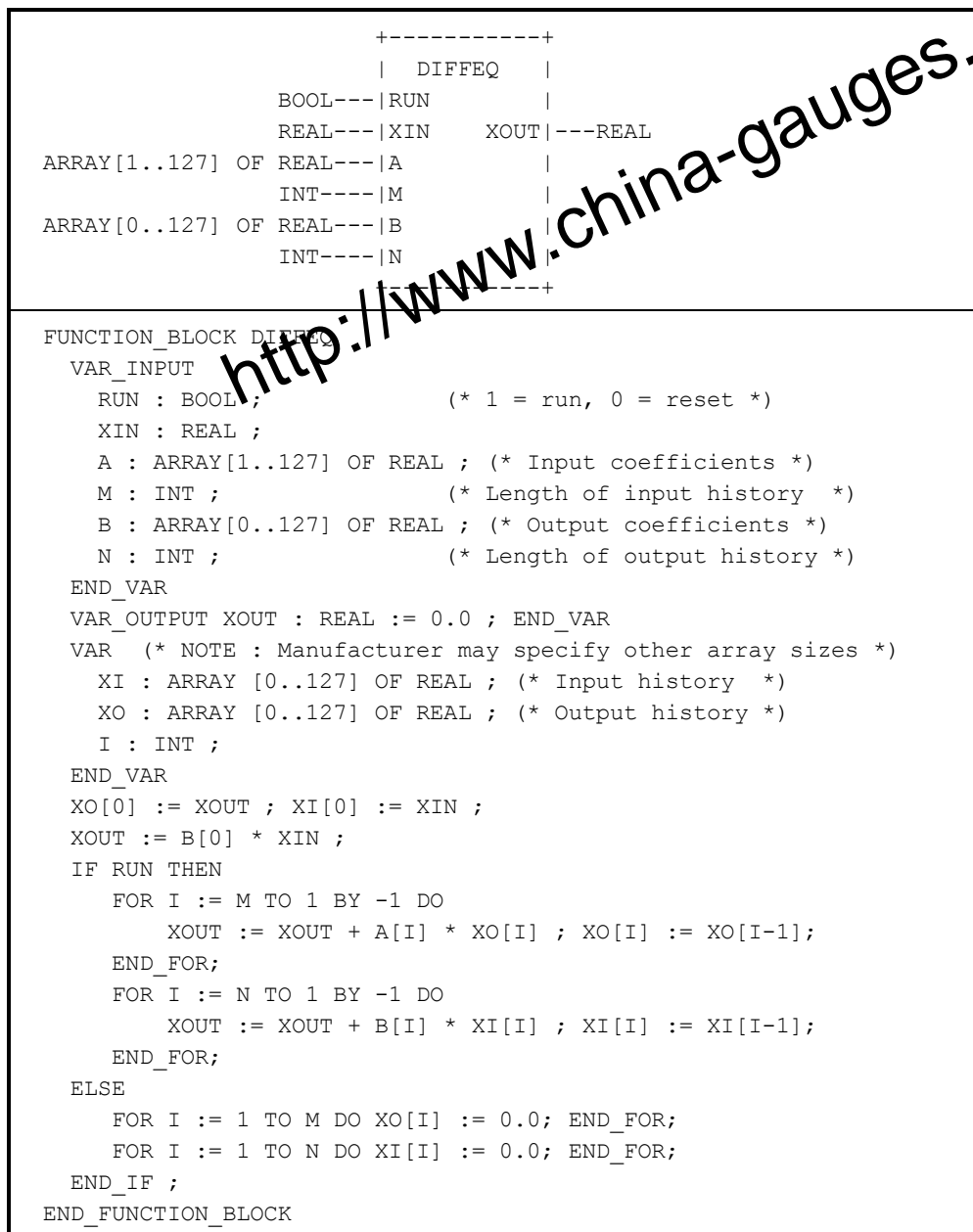

<http://www.china-gauges.com/>

F.6.12 Function block RAMP

This function block implements a time-based ramp.



<http://www.china-gauges.com/>

F.6.13 Function block TRANSFER

This function block implements a manual transfer station with bumpless transfer.

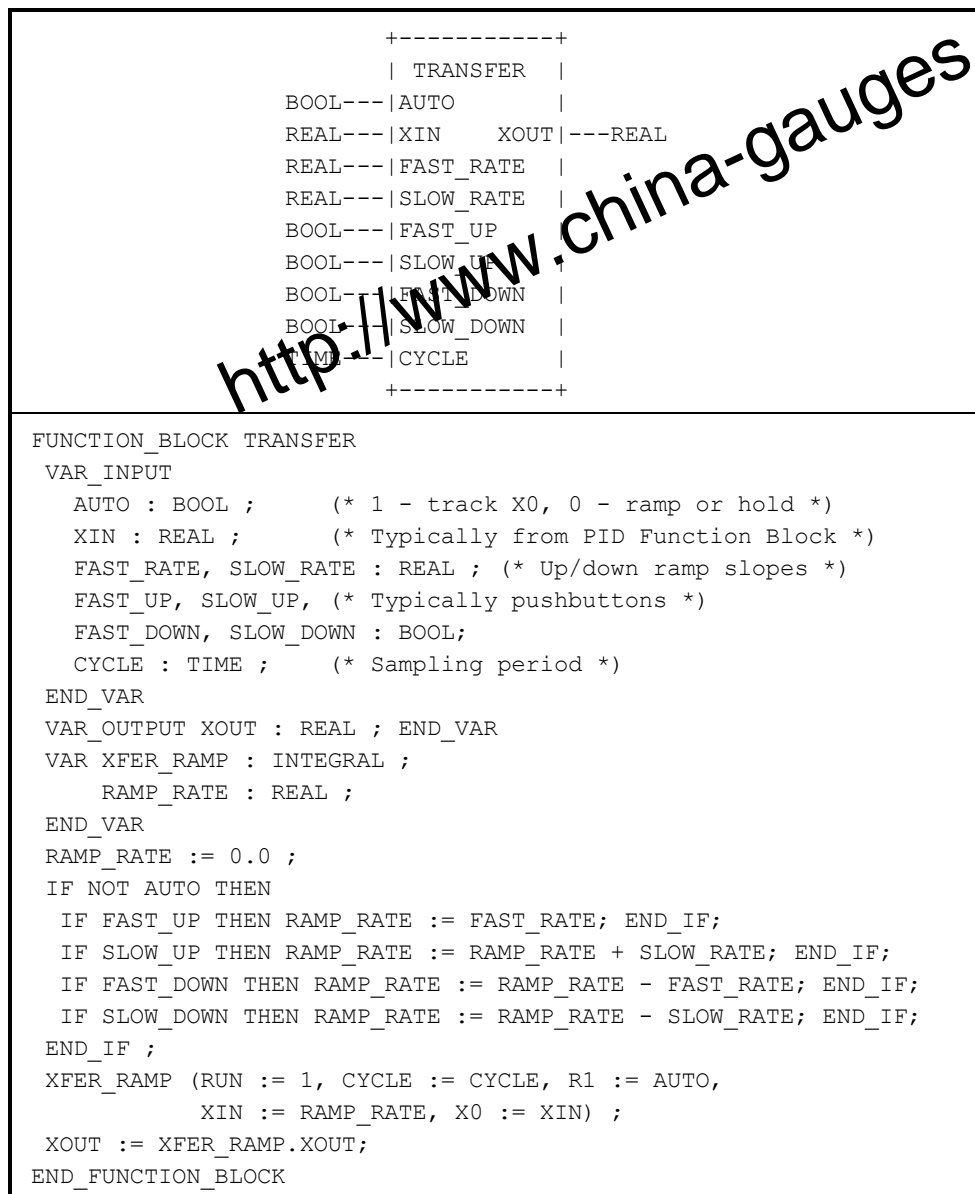

F.7 Program GRAVEL

A control system is to be used to measure an operator-specified amount of gravel from a silo into an intermediate bin, and to convey the gravel after measurement from the bin into a truck.

The quantity of gravel to be transferred is specified via a thumbwheel with a range of 0 to 99 units. The amount of gravel in the bin is indicated on a digital display.

For safety reasons, visual and audible alarms must be raised immediately when the silo is empty. The signalling functions are to be implemented in the control program.

A graphic representation of the control problem is shown in figure F.2, while the variable declarations for the control program are given in figure F.3.

<http://www.china-gauges.com/>

As shown in figure F.4, the operation of the system consists of a number of major states, beginning with filling of the bin upon command from the `FILL` push button. After the bin is filled, the truck loading sequence begins upon command by the `LOAD` pushbutton when a truck is present on the ramp. Loading consists of a "run-in" period for starting the conveyor, followed by dumping of the bin contents onto the conveyor. After the bin has emptied, the conveyor "runs out" for a predetermined time to assure that all gravel has been loaded to the truck. The loading sequence is stopped and re-initialized if the truck leaves the ramp or if the automatic control is stopped by the `OFF` push button.

Figure F.5 shows the `OFF/ON` sequence of automatic control states, as well as the generation of display blinking pulses and conveyor motor gating when the control is `ON`.

Bin level monitoring, operator interface and display functions are defined in figure F.6.

A textual version of the body of program `GRAVEL` is given in figure F.7, using the ST language with SFC elements.

An example configuration for program `GRAVEL` is given in figure F.8.

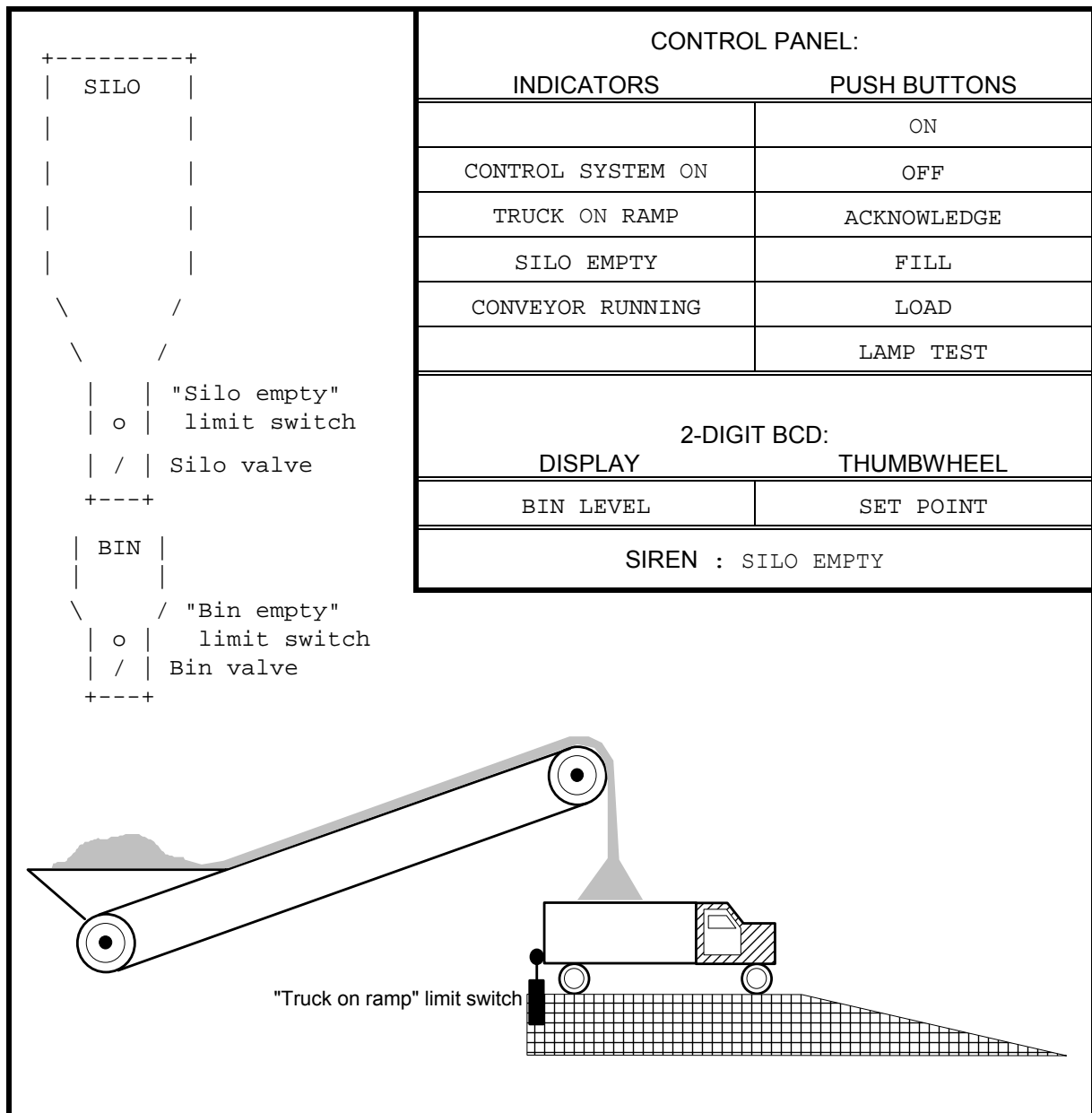

Figure F.2 - Gravel measurement and loading system

```

PROGRAM GRAVEL (* Gravel measurement and loading system *)

VAR_INPUT
  OFF_PB      : BOOL ;
  ON_PB       : BOOL ;
  FILL_PB     : BOOL ;
  SIREN_ACK   : BOOL ;
  LOAD_PB     : BOOL ; (* Load truck from bin *)
  JOG_PB      : BOOL ;
  LAMP_TEST   : BOOL ;
  TRUCK_ON_RAMP : BOOL ; (* Optical sensor *)
  SILO_EMPTY_LS : BOOL ;
  BIN_EMPTY_LS : BOOL ;
  SETPOINT    : BYTE ; (* 4-digit BCD *)
END_VAR

VAR_OUTPUT
  CONTROL_LAMP : BOOL ;
  TRUCK_LAMP   : BOOL ;
  SILO_EMPTY_LAMP : BOOL ;
  CONVEYOR_LAMP : BOOL ;
  CONVEYOR_MOTOR : BOOL ;
  SILO_VALVE   : BOOL ;
  BIN_VALVE    : BOOL ;
  SIREN        : BOOL ;
  BIN_LEVEL    : BYTE ;
END_VAR

VAR
  BLINK_TIME : TIME; (* BLINK ON/OFF time *)
  PULSE_TIME : TIME; (* LEVEL_CTR increment interval *)
  RUNOUT_TIME: TIME; (* Conveyor running time after loading *)
  RUN_IN_TIME: TIME; (* Conveyor running time before loading *)
  SILENT_TIME: TIME; (* Siren silent time after SIREN_ACK *)
  OK_TO_RUN  : BOOL; (* 1 = Conveyor is allowed to run *)

  (* Function Blocks *)
  BLINK: TON; (* Blinker OFF period timer / ON output *)
  BLANK: TON; (* Blinker ON period timer / blanking pulse *)
  PULSE: TON; (* LEVEL_CTR pulse interval timer *)
  SIREN_FF: RS;
  SILENCE_TMR: TP; (* Siren silent period timer *)
END_VAR

VAR RETAIN LEVEL_CTR : CTU ; END_VAR

  (* Program body *)

END_PROGRAM

```

IEC 2504/02

Figure F.3 - Declarations for program GRAVEL

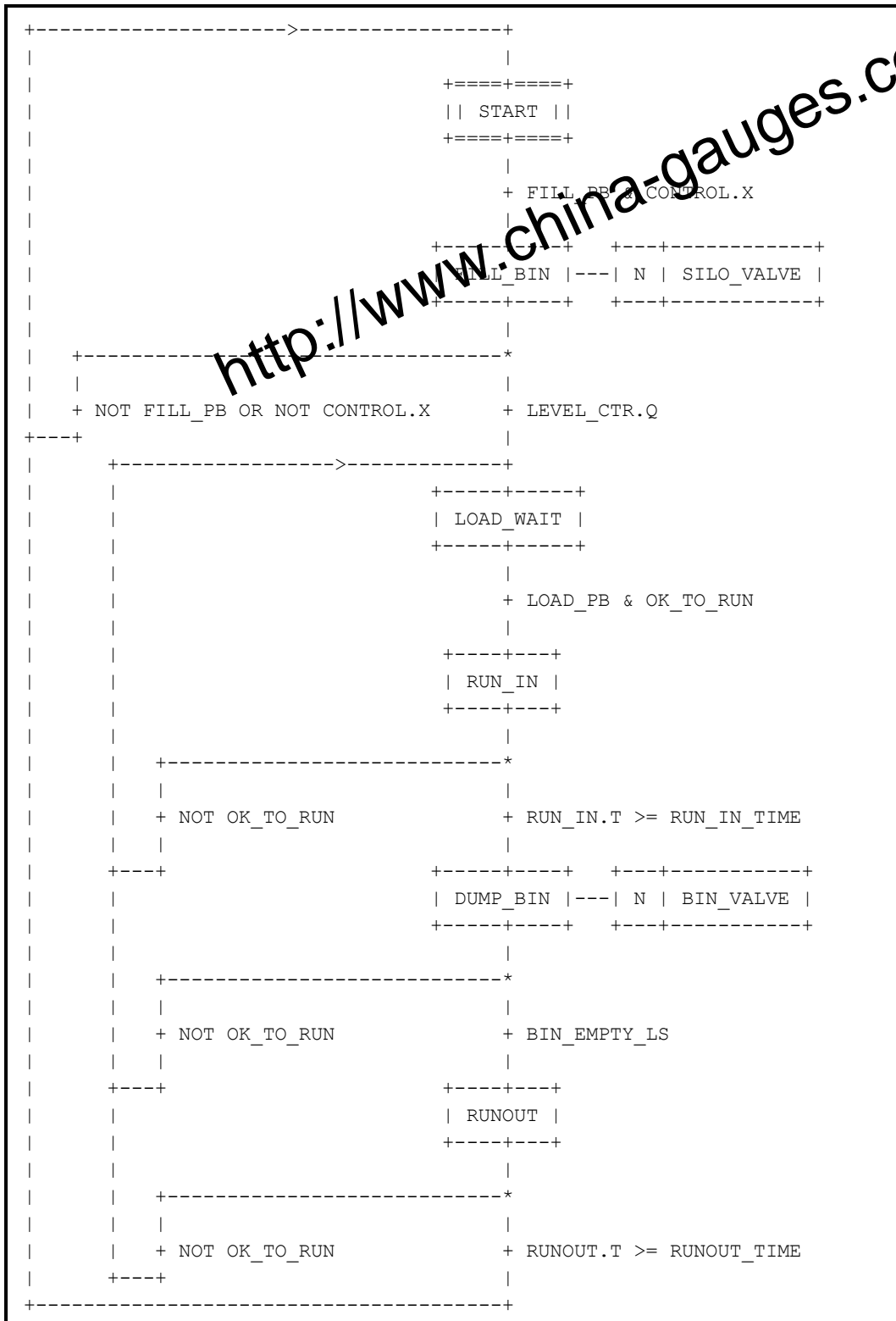

<http://www.china-gauges.com/>

IEC 2505/02

Figure F.4 - SFC of program GRAVEL body

```

+-----+
+ OFF_PB
+-----+-----+ +-----+ +-----+
||CONTROL_OFF|| || MONITOR ||---| N | MONITOR_ACTION
+-----+-----+ +-----+ +-----+
+ ON_PB & NOT OFF_PB
+-----+ +-----+-----+-----+
|CONTROL|--| N | CONTROL_ACTION |
+-----+ +-----+-----+-----+
+-----+ | BLINK BLANK |
| | +-+ +-----+ +-----+ |
| +---O|&| | TON | | TON | |
|CONTROL.X--| |-----| IN Q|-----| IN Q|---+
| +-+ +---|PT | +---|PT |
| | +-----+ | +-----+
| BLINK_TIME--++-----+
| +-+
|CONTROL.X-----|&|
|TRUCK_ON_RAMP--| |-----+-----OK_TO_RUN
| +-+ | +-+
| +-----+ +---|&|--CONVEYOR_MOTOR
|JOG_PB-----| >=1 |-----| |
|RUN_IN.X----| | +-+
|DUMP_BIN.X--| |
|RUNOUT.X----| |
| +-----+
+-----+
    
```

<http://www.china-gauges.com/>

IEC 2506/02

Figure F.5 - Body of program GRAVEL (continued) - control state sequencing and monitoring

Figure F.7 - Body of program GRAVEL in textual SFC representation using ST language elements

```
(* Major operating states *)
INITIAL_STEP START : END_STEP
TRANSITION FROM START TO FILL_BIN
    := FILL_PB & CONTROL.X ; END_TRANSITION

STEP FILL_BIN: SILO_VALVE(N); END_STEP
TRANSITION FROM FILL_BIN TO START
    := NOT FILL_PB OR NOT CONTROL.X ; END_TRANSITION
TRANSITION FROM FILL_BIN TO LOAD_WAIT := LEVEL_CTR.Q ;
END_TRANSITION

STEP LOAD_WAIT: END_STEP
TRANSITION FROM LOAD_WAIT TO RUN_IN
    := LOAD_PB & OK_TO_RUN ; END_TRANSITION

STEP RUN_IN : END_STEP
TRANSITION FROM RUN_IN TO LOAD_WAIT := NOT OK_TO_RUN ;
END_TRANSITION
TRANSITION FROM RUN_IN TO DUMP_BIN
    := RUN_IN.T > RUN_IN_TIME;
END_TRANSITION

STEP DUMP_BIN: BIN_VALVE(N); END_STEP
TRANSITION FROM DUMP_BIN TO LOAD_WAIT := NOT OK_TO_RUN ;
END_TRANSITION
TRANSITION FROM DUMP_BIN TO RUNOUT := BIN_EMPTY_LS ;
END_TRANSITION

STEP RUNOUT : END_STEP
TRANSITION FROM RUNOUT TO LOAD_WAIT := NOT OK_TO_RUN ;
END_TRANSITION
TRANSITION FROM RUNOUT TO START
    := RUNOUT.T >= RUNOUT_TIME ; END_TRANSITION

(* Control state sequencing *)
INITIAL_STEP CONTROL_OFF: END_STEP
TRANSITION FROM CONTROL_OFF TO CONTROL
    := ON_PB & NOT OFF_PB ; END_TRANSITION

STEP CONTROL: CONTROL_ACTION(N); END_STEP
ACTION CONTROL_ACTION:
    BLINK(EN:=CONTROL.X & NOT BLANK.Q, PT := BLINK_TIME) ;
    BLANK(EN:=BLINK.Q, PT := BLINK_TIME) ;
    OK_TO_RUN := CONTROL.X & TRUCK_ON_RAMP ;
    CONVEYOR_MOTOR :=
        OK_TO_RUN & OR(JOG_PB, RUN_IN.X, DUMP_BIN.X, RUNOUT.X);
END_ACTION
TRANSITION FROM CONTROL TO CONTROL_OFF := OFF_PB ;
END_TRANSITION
```

<http://www.china-gauges.com/>

Figure F.7 - Body of program GRAVEL in textual SFC representation using ST language elements

```
(* Monitor Logic *)
INITIAL_STEP MONITOR: MONITOR_ACTION(N); END_STEP
ACTION MONITOR_ACTION:
  CONVEYOR_LAMP := CONVEYOR_MOTOR & BLINK.Q ;
  CONTROL_LAMP := CONTROL.X OR LAMP_TEST ;
  TRUCK_LAMP := TRUCK_ON_RAMP OR LAMP_TEST ;
  SILO_EMPTY_LAMP := BLINK.Q & SILO_EMPTY_LS OR LAMP_TEST ;
  SILENCE_TMR(IN:=SIREN_ACK, PT:=SILENCE_TIME) ;
  SIREN_FF(S:=SILO_EMPTY_LS, R1:=SILENCE_TMR.Q) ;
  SIREN := SIREN_FF.Q1 ;
  PULSE(IN:=FILL_BIN.X & NOT PULSE.Q, PT:=PULSE_TIME) ;
  LEVEL_CTR(R := BIN_EMPTY_LS, CU := PULSE.Q,
            PV := BCD_TO_INT(SETPOINT)) ;
  BIN_LEVEL := INT_TO_BCD(LEVEL_CTR.CV) ;
END_ACTION
```

IEC 2508/02

```
CONFIGURATION GRAVEL_CONTROL
RESOURCE PROC1 ON PROC_TYPE_Y
PROGRAM G : GRAVEL
  (* Inputs *)
  (OFF_PB      := %I0.0 ,
   ON_PB       := %I0.1 ,
   FILL_PB     := %I0.2 ,
   SIREN_ACK   := %I0.3 ,
   LOAD_PB    := %I0.4 ,
   JOG_PB     := %I0.5 ,
   LAMP_TEST   := %I0.7 ,
   TRUCK_ON_RAMP := %I1.4 ,
   SILO_EMPTY_LS := %I1.5 ,
   BIN_EMPTY_LS := %I1.6 ,
   SETPOINT    := %IB2 ,
  (* Outputs *)
  CONTROL_LAMP => %Q4.0,
  TRUCK_LAMP   => %Q4.2,
  SILO_EMPTY_LAMP => %Q4.3,
  CONVEYOR_LAMP => %Q5.3,
  CONVEYOR_MOTOR => %Q5.4,
  SILO_VALVE    => %Q5.5,
  BIN_VALVE     => %Q5.6,
  SIREN         => %Q5.7,
  BIN_LEVEL     => %B6) ;
END_RESOURCE
END_CONFIGURATION
```

IEC 2509/02

Figure F.8 - Example configuration for program GRAVEL

F.8 Program AGV

As illustrated in figure F.9, a program is to be devised to control an automatic guided vehicle (AGV). The AGV is to travel between two extreme positions, left (indicated by limit switch S3) and right (indicated by limit switch S4). The normal position of the AGV is on the left.

The AGV is to execute one cycle of left-to-right and return motion when the operator actuates pushbutton S1, and two cycles when the operator actuates pushbutton S2. It is also possible to pass from a single to a double cycle by actuating pushbutton S2 during a single cycle. Finally, non-repeat locking is to be provided if either S1 or S2 remains actuated.

Figure F.10 illustrates the graphical declaration of program AGV, while figure F.11 shows a typical configuration for this program. Figure F.12 shows the AGV program body, consisting of a main control sequence and a single-cycle control sequence.

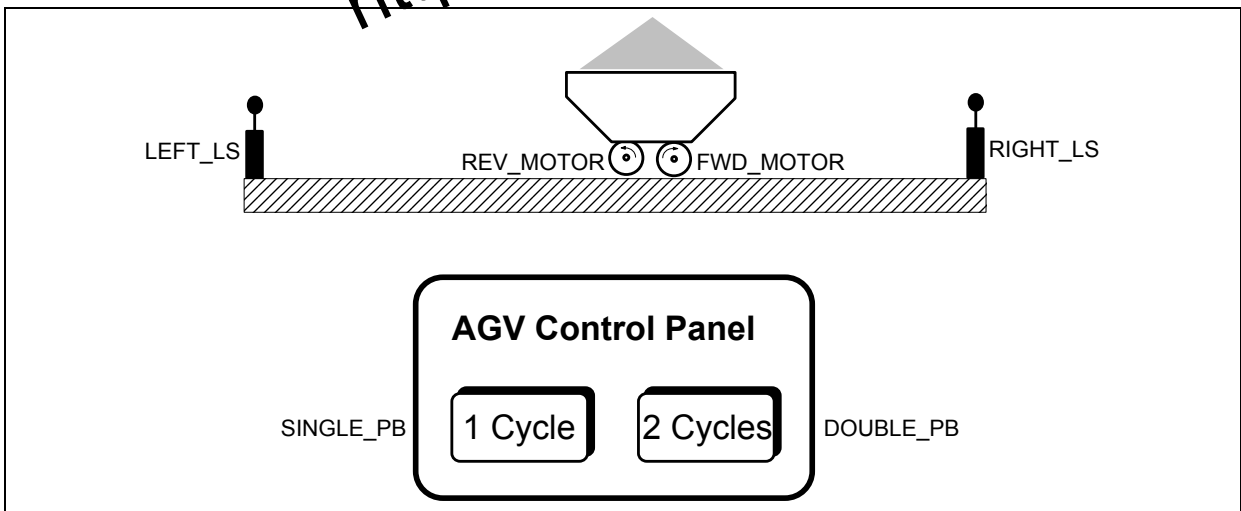

IEC 2510/02

Figure F.9 - Physical model for program AGV

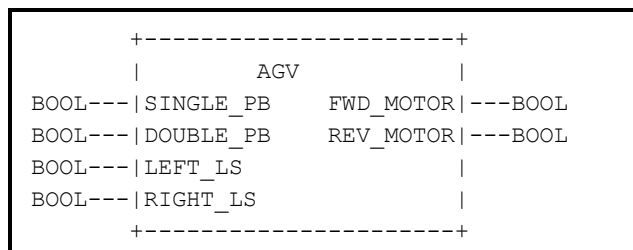

IEC 2511/02

Figure F.10 - Graphical declaration of program AGV

```
+-----+
|
|
+====+-----+      (* Perform a single cycle *)
| |READY| |
+====+-----+
|
|   + CYCLE
|
+-----+ +-----+
|FORWARD+- |N|FWD_MOTOR|
+-----+ +-----+
|
|   + RIGHT_LS
|
+-----+ +-----+
|REVERSE+- |N|REV_MOTOR|
+-----+ +-----+
|
|   + LEFT_LS
|
+---+
|DONE|
+---+
|
|   + NOT CYCLE
|
+-----+
```

<http://www.china-gauges.com/>

IEC 2513/02

Figure F.12 - Body of program AGV (continued)

F.9 Use of enumerated data types

The following example illustrates the use of enumerated data types in ST `CASE` statements and in Instruction List. Suppose an enumerated data type has been defined by the following declaration:

```
TYPE SPEED: (SLOW, MEDIUM, FAST, VERY_FAST); END_TYPE
```

In addition, suppose an input and output of a function block type is declared by:

```
VAR_INPUT MOTOR_SPEED: SPEED; END_VAR
VAR_OUTPUT SPEED_OUT: SPEED; END_VAR
```

Then if the body of the function block type is defined in the ST language, a `CASE` statement such as the following could be used:

```
CASE MOTOR_SPEED OF
  SLOW:   (* speed it up *);
  MEDIUM: (* hold the current speed *);
  FAST:   (* slow it down *);
ELSE     (* take special care *);
END_CASE;
```

If the body of the function block type is defined in the IL language, the following instructions could be used:

```
LD SPEED#SLOW   (* enumerated value qualified by data type *)
ST SPEED_OUT
```

F.10 Function block `RTC` (Real Time Clock)

The `RTC` function block shown below sets the output `CDT` to the input value `PDT` at the next evaluation of the function block following a transition from 0 to 1 of the `IN` input. The `CDT` output of the `RTC` function block is undefined when the value of `IN` is 0.

Function block `RTC` (Real Time Clock)

<p><code>PDT</code> = Preset date and time, loaded on rising edge of <code>IN</code></p> <p><code>CDT</code> = Current date and time, valid when <code>IN</code>=1</p> <p><code>Q</code> = copy of <code>IN</code></p>	<pre>+-----+ RTC BOOL--- IN Q ---BOOL DT----- PDT CDT -----DT +-----+</pre>
--	---

F.11 Function block `ALRM_INT`

This function block type provides simple high and low level alarming for an input of type `INT` and illustrates the use of the `VAR_OUTPUT` declaration with functions. The function output is `TRUE` if a high or low threshold is exceeded, and separate outputs are provided for the high- or low-level alarm conditions.

<pre> +-----+ ALRM_INT IN--- INT ---BOOL THI--- INT HI ---BOOL THL--- INT LO ---BOOL +-----+ +----+ IN--- > -----HI THI-- +----+ +----+ +--- OR ---ALRM_INT +--- +----+ +----+ IN--- < -----LO THL-- +----+ </pre>	<pre> FUNCTION ALRM_INT : BOOL VAR_INPUT INT : IN ; INT : THI ; (* High threshold *) INT : TLO ; (* Low threshold *) END_VAR VAR_OUTPUT HI : BOOL; (* High level alarm *) LO : BOOL; (* Low level alarm *) END_VAR HI := IN > THI ; LO := IN < THL ; ALRM_INT := THI OR THL ; END_FUNCTION </pre>
---	---

<http://www.china-gauges.com/>

ANNEX G
(informative)
Reference character set

- NOTE 1 The contents of the most recent edition of "table 1Row 00: ISO-646 IRV" of ISO/IEC 10646-1 are normative for the purposes of this standard. The reference character set is reproduced here for information only.
- NOTE 2 In variables of type `STRING`, the individual byte encodings of the characters in this reference character set are as given in table H.1. In variables of type `WSTRING`, the numerical equivalent of individual 16-bit word encodings are also as given in table H.2.

Table G.1 Character representations

Second hexadecimal digit	First hexadecimal digit					
	2	3	4	5	6	7
0		0	@	P	`	p
1	!	1	A	Q	a	q
2	"	2	B	R	b	r
3	#	3	C	S	c	s
4	\$	4	D	T	d	t
5	%	5	E	U	e	u
6	&	6	F	V	f	v
7	'	7	G	W	g	w
8	(8	H	X	h	x
9)	9	I	Y	i	y
A	*	:	J	Z	j	z
B	+	;	K	[k	{
C	,	<	L	\	l	
D	-	=	M]	m	}
E	.	>	N	^	n	~
F	/	?	O	_	o	

Table G.2 - Character encodings

dec	hex	Name	dec	hex	Name
032	20	SPACE	080	50	LATIN CAPITAL LETTER P
033	21	EXCLAMATION MARK	081	51	LATIN CAPITAL LETTER Q
034	22	QUOTATION MARK	082	52	LATIN CAPITAL LETTER R
035	23	NUMBER SIGN	083	53	LATIN CAPITAL LETTER S
036	24	DOLLAR SIGN	084	54	LATIN CAPITAL LETTER T
037	25	PERCENT SIGN	085	55	LATIN CAPITAL LETTER U
038	26	AMPERSAND	086	56	LATIN CAPITAL LETTER V
039	27	APOSTROPHE	087	57	LATIN CAPITAL LETTER W
040	28	LEFT PARENTHESIS	088	58	LATIN CAPITAL LETTER X
041	29	RIGHT PARENTHESIS	089	59	LATIN CAPITAL LETTER Y
042	2A	ASTERISK	090	5A	LATIN CAPITAL LETTER Z
043	2B	PLUS SIGN	091	5B	LEFT SQUARE BRACKET
044	2C	COMMA	092	5C	REVERSE SOLIDUS
045	2D	HYPHEN-MINUS	093	5D	RIGHT SQUARE BRACKET
046	2E	FULL STOP	094	5E	CIRCUMFLEX ACCENT
047	2F	SOLIDUS	095	5F	LOW LINE
048	30	DIGIT ZERO	096	60	GRAVE ACCENT
049	31	DIGIT ONE	097	61	LATIN SMALL LETTER A
050	32	DIGIT TWO	098	62	LATIN SMALL LETTER B
051	33	DIGIT THREE	099	63	LATIN SMALL LETTER C
052	34	DIGIT FOUR	100	64	LATIN SMALL LETTER D
053	35	DIGIT FIVE	101	65	LATIN SMALL LETTER E
054	36	DIGIT SIX	102	66	LATIN SMALL LETTER F
055	37	DIGIT SEVEN	103	67	LATIN SMALL LETTER G
056	38	DIGIT EIGHT	104	68	LATIN SMALL LETTER H
057	39	DIGIT NINE	105	69	LATIN SMALL LETTER I
058	3A	COLON	106	6A	LATIN SMALL LETTER J
059	3B	SEMICOLON	107	6B	LATIN SMALL LETTER K
060	3C	LESS-THAN SIGN	108	6C	LATIN SMALL LETTER L
061	3D	EQUALS SIGN	109	6D	LATIN SMALL LETTER M
062	3E	GREATER-THAN SIGN	110	6E	LATIN SMALL LETTER N
063	3F	QUESTION MARK	111	6F	LATIN SMALL LETTER O
064	40	COMMERCIAL AT	112	70	LATIN SMALL LETTER P
065	41	LATIN CAPITAL LETTER A	113	71	LATIN SMALL LETTER Q
066	42	LATIN CAPITAL LETTER B	114	72	LATIN SMALL LETTER R
067	43	LATIN CAPITAL LETTER C	115	73	LATIN SMALL LETTER S
068	44	LATIN CAPITAL LETTER D	116	74	LATIN SMALL LETTER T
069	45	LATIN CAPITAL LETTER E	117	75	LATIN SMALL LETTER U
070	46	LATIN CAPITAL LETTER F	118	76	LATIN SMALL LETTER V
071	47	LATIN CAPITAL LETTER G	119	77	LATIN SMALL LETTER W
072	48	LATIN CAPITAL LETTER H	120	78	LATIN SMALL LETTER X
073	49	LATIN CAPITAL LETTER I	121	79	LATIN SMALL LETTER Y
074	4A	LATIN CAPITAL LETTER J	122	7A	LATIN SMALL LETTER Z
075	4B	LATIN CAPITAL LETTER K	123	7B	LEFT CURLY BRACKET
076	4C	LATIN CAPITAL LETTER L	124	7C	VERTICAL LINE
077	4D	LATIN CAPITAL LETTER M	125	7D	RIGHT CURLY BRACKET
078	4E	LATIN CAPITAL LETTER N	126	7E	TILDE
079	4F	LATIN CAPITAL LETTER O			

Annex ZA (normative)

Normative references to international publications with their corresponding European publications

This European Standard incorporates by dated or undated reference, provisions from other publications. These normative references are cited at the appropriate places in the text and the publications are listed hereafter. For dated references, subsequent amendments to or revisions of any of these publications apply to this European Standard only when incorporated in it by amendment or revision. For undated references the latest edition of the publication referred to applies (including amendments).

NOTE When an international publication has been modified by common modifications, indicated by (mod), the relevant EN/HD applies.

<u>Publication</u>	<u>Year</u>	<u>Title</u>	<u>EN/HD</u>	<u>Year</u>
IEC 60050	Series	International Electrotechnical Vocabulary	-	-
IEC 60559	1989	Binary floating-point arithmetic for microprocessor systems	HD 592 S1	1991
IEC 60617-12	1997	Graphical symbols for diagrams Part 12: Binary logic elements	EN 60617-12	1998
IEC 60617-13	1993	Part 13: Analogue elements	EN 60617-13	1993
IEC 60848	2002	GRAFCET specification language for sequential function charts	EN 60848	2002
IEC 61131-1	- ¹⁾	Programmable controllers Part 1: General information	EN 61131-1	1994 ²⁾
IEC 61131-5	- ¹⁾	Part 5: Communications	EN 61131-5	2001 ²⁾
ISO/AFNOR	1989	Dictionary of computer science - The standardised vocabulary	-	-
ISO/IEC 10646-1	1993	Information technology - Universal Multiple-Octet Coded Character set (UCS) - Part 1: Architecture and Basic Multilingual Plane	-	-

¹⁾ Undated reference.

²⁾ Valid edition at date of issue.

Index

Primary references for *delimiters* and *keywords* are given in annex C.

- absolute time, 28
- access path, 108, 110
 - communication, 16
 - keyword, 39
 - loading/deletion, 16
 - programming, 18
- action, 84, 89, 123
 - control, 94
 - qualifiers, 93
- action block, 89, 91, 92, 95
- active association, 95
- active association, 95
- activity flow, 135
- aggregate, 10
- argument, 66, 130, 133
- array
 - declaration, 32, 42
 - initialization, 33, 42
 - location assignment, 42
 - usage, 38, 134
- assignment, 86
 - FOR loop variable values, 134
 - operator, 33, 86
 - statement, 133
- assignment, 47, 49, 51, 68
- based number, 10, 25
- bistable function block, 77
- bit string
 - comparison, 59
 - data types, 30
 - functions, 59
 - initial value assignment, 42
 - variable declaration, 41
- body
 - function, 51, 133
 - function, 49, 68
 - function block, 66
 - program organization unit, 136
- Boolean
 - AND, in ladder diagrams, 140
 - data type, 30
 - default initial value, 34
 - edge detection, 69, 78
 - expression, 86, 130, 133, 134
 - functions, 59
 - functions, 95
 - input, action control, 95

<http://www.china-gauges.com/>

- input, RETURN, 138
 - literals, 25
 - negation, 47
 - operators, 130
 - OR, LD vs. FBD, 143
 - output, 138
 - signal, 138
 - values, power flow, 139
 - variable, 84, 85, 89, 90, 94, 114, 134, 138
 - variable, in ladder diagrams, 140
- byte (data element size), 37
 - BYTE (data type), 30, 34
 - case (of characters), 23, 24, 28
 - CASE statement, 133
 - character code, 24, 62
 - character set, 23, 84, 135, 141
 - character string
 - character positions in, 62
 - comparison, 62
 - data type, 30
 - functions, 62
 - initialization, 42
 - literals, 26
 - variable declaration, 41
 - cold restart, 38, 41, 42, 43, 44
 - comment, 24
 - comparison
 - bit strings, 59
 - character strings, 62
 - functions, 59, 66
 - compilation, 21
 - compliance, 19
 - action declarations, 89
 - EXIT statement, 132
 - programs, 22
 - sequential function chart (SFC), 108
 - step/action association, 91
 - syntax, 21
 - system, 20
 - concatenation
 - action blocks, 91, 93
 - hierarchical addresses, 36
 - time data, 64
 - conditional
 - jump, 138
 - return, 138
 - configuration
 - communication, 16
 - elements, 108
 - initialization, 15
 - programming, 18
 - starting and stopping, 15

<http://www.china-gauges.com/>

- connection, 83
- connector, 86, 88, 135, 136
- contact, 140
- counter, 78
- data type
 - compliance, 21
 - declaration, 32
 - elementary, 30
 - generic, 31, 53
 - initialization, 33
 - of an expression, 129
 - of functions, 50
 - of internal variables, 50
 - programming, 18
 - usage, 35
- date and time, 81
 - data types, 30
 - default initial values, 34
 - functions, 64
 - literals, 29
- decimal number (decimal literal), 25, 135
- declaration, 18
 - access paths, 110
 - actions, 89, 94
 - configurations, 108
 - data types, 32
 - function blocks, 66, 69
 - functions, 50, 133
 - programs, 83
 - resources, 110
 - tasks, 114
 - variables, 39
- default value, 52
 - FOR increment, 134
 - of data types, 33
 - of variables, 38, 42
 - task interval, 114
- delimiter
 - comments, 24
 - LD network, 139
 - network label, 135
 - time literals, 28
- direct representation, 36, 83, 111
 - in programs, 83
 - initial value assignment, 42
 - variable declaration, 41
- double word, 30
 - size prefix, 37
- duration
 - data type (TIME), 30
 - literals, 28
 - of action qualifiers, 93
 - of step activity, 100

<http://www.china-gauges.com/>

edge detection, 69
 function blocks, 78

EN/ENO (enable) variables, 49, 50, 68

errors, 24, 32, 36, 40, 46, 47, 49, 52, 55, 56, 59, 61, 63, 64, 69, 85, 87, 95, 100, 114, 115, 124, 130, 133, 134, 137, 167
 documentation, 21
 handling, 21, 22
 reporting, 21

errors, 85, 100, 135

evaluation

 of assignment statements, 133
 of expressions, 129
 of function blocks, 115
 of functions, 58, 130, 133
 of language elements, 115
 of network elements, 136
 of networks, 66, 136, 141, 143
 of programs, 115
 of transitions, 100

execution

 of actions, 84
 of EXIT statements, 134
 of function blocks, 66, 78, 115
 of functions, 49
 of iteration statements, 134
 of loop elements, 137
 of programs, 138
 of selection statements, 133

execution control element, 84, 114, 136, 138, 141

extensions, 21, 37
 documentation, 21
 processing, 21
 usage, 22

extensions, 24

falling edge, 69, 71, 78

feedback

 path, 137
 variable, 137

FOR statement, 134

function, 45

 compliance, 21
 control statements, 133
 extensible, 55
 in LD language, 140
 overloaded, 53, 56, 59
 programming, 18
 return value, 133
 signal flow, 135
 typing, 53

function (procedure), 11

function block, 11, 14, 66
 action control, 94

<http://www.china-gauges.com/>

- communication, 16, 83
 - compliance, 21
 - control statements, 133
 - in LD language, 140
 - instance, 114, 115
 - operation, 78, 81
 - programming, 18
 - retentive, 85
 - SFC structuring, 84
 - signal flow, 135
 - type, 67
- function block diagram, 11
 - function block diagram (FBD), 14, 143
 - action blocks in, 93
 - execution control, 138
 - loops in, 137
 - signal flow in, 135
 - function block instance, 11
 - function block type, 11
 - generic data types, 31, 53
 - global variable, 108
 - communication, 16
 - declaration, 39, 83, 110
 - function block instance, 66
 - initial value assignment, 42
 - initialization, 15
 - loading/deletion, 16
 - programming, 18
 - hierarchical addressing, 37
 - identifier, 23, 66, 84, 86, 135
 - identifier, 50
 - implementation-dependent
 - feature, 21, 22, 38, 42, 134
 - side effects, 68
 - implementation-dependent parameters, 20, 24, 32, 33, 37, 40, 45, 51, 55, 56, 66, 81, 83, 85, 87, 91, 100, 114, 129, 131, 133, 135, 165
 - initial
 - state, 84
 - step, 84, 85, 99
 - initial value
 - assignment, 42
 - default, 33
 - feedback variable, 137
 - FOR loop variable, 134
 - initialization, 38
 - function blocks, 69
 - function blocks, 99
 - programs, 83
 - programs, 99
 - SFC networks, 99
 - steps, 85
 - initialization, 15

<http://www.china-gauges.com/>

input

- declaration, 39, 50, 69
- dynamic, 69
- extensible, 55
- initialization, 38
- instance name, 66
- location prefix, 37
- negated, 47
- overloaded, 53
- program, 111
- string, 56
- variable, 67, 140
- variable, 83

input/output

- variable, 66

instance

- function block, 66, 67, 69, 70, 71, 114, 115
- name, 66, 67, 70, 71

instantiation

- action control, 95
- function block, 83
- program, 83

instruction, 86, 89

integer

- data types, 30, 134
- literal, 12, 25, 135

invocation

- by tasks, 114
- function block, 133
- function block, 66, 67, 69
- of actions, 84
- of functions, 129
- of non-PC language elements, 18
- recursive, 45
- return from, 138

iteration, 132, 134

keyword, 24

- Boolean literals, 26, 86
- data types, 30
- ELSE statement, 133
- FOR statement, 134
- function block declaration, 69
- function declaration, 50
- IF statement, 133
- program declaration, 83
- REPEAT statement, 134
- time literals, 28
- transition, 86
- variable declaration, 39
- WHILE statement, 134

label

- connector, 135
- network, 135, 136, 138

ladder diagram, 139

<http://www.china-gauges.com/>

- evaluation, 136
 - execution control, 138
 - network, 86
- language element, 14
 - compliance, 19
 - programming, 18, 83
- library, 18, 110
- literal, 25, 129, 139
- logical location, 36, 37, 39, 41
- long real, 30
- long word, 30
- memory, 140
- memory (user data storage)
 - allocation, 39
 - direct representation, 36
 - initial value assignment, 42
 - initialization, 38
- named element, 38, 135
- network, 12, 94
 - direction of flow, 135
 - evaluation, 66, 136, 141, 143
 - function block diagram (FBD), 86, 89
 - label, 138
 - ladder diagram (LD), 86, 139
 - sequential function chart (SFC), 84, 98, 99
- network, 135
- numeric literals, 25
- off-delay, 12, 81
- on-delay, 12, 81
- operand
 - of an expression, 129
- operator
 - assignment, 33, 86, 133
 - overloaded, 53
 - precedence, 129, 130
 - Structured Text (ST), 129
 - symbols, 58, 60, 62, 65
- output
 - action control, 94
 - declaration, 69
 - function block, 132, 143
 - location prefix, 37
 - negated, 47
 - program, 111
 - string, 56
 - typed, 53
 - values, 66
 - variable declaration, 39
 - variables, 67, 83, 140
 - variables, 66

<http://www.china-gauges.com/>

overloading, 53
 of operators, 130
 parentheses, 24, 33, 38, 43, 86, 130
 power flow, 93, 135, 138, 139, 141
 power rails, 139
 power rails, 135, 138, 139
 pre-emptive scheduling, 114
 priority
 of tasks, 114
 of transitions, 100
 program, 14, 18, 83
 communication, 16
 compliance, 22
 declaration, 39, 83, 111
 declaration, 66, 75
 retentive, 85
 scheduling, 114
 SFC structuring, 84
 program organization unit, 45, 66
 compliance, 20
 declaration, 39, 46
 initial state, 84
 jumps in, 138
 networks in, 135, 136, 141
 scheduling, 114
 SFC partitioning of, 84
 state, 84
 programming, 18, 139
 programming, 143
 real literal, 25
 resource, 14, 83
 communication, 17
 declaration, 110
 global variables in, 111
 initialization, 15, 38
 programming, 18
 starting and stopping, 15, 115
 retentive data
 declaration, 39, 83
 in function blocks, 69
 in steps, 85
 initial value assignment, 42
 initialization, 38
 type assignment, 41
 return, 132, 133, 138
 rising edge, 69, 71, 78, 114, 206
 rung, 139
 rung, 89
 scope
 global, 111

<http://www.china-gauges.com/>

- of actions, 89
- of declarations, 40
- of function block instances, 66
- of networks, 135
- of steps, 84
- of transitions, 87
- selection
 - functions, 59, 66
 - statements, 133
- semantics
 - Structured Text (ST), 129
- semigraphic representation, 69, 114, 135, 136
- sequential function chart (SFC)
 - activity flow, 135
 - compliance, 108
 - convergence, simultaneous, 100
 - divergence, selection, 100
 - divergence, simultaneous, 100
 - elements, 14, 84
 - elements, 123, 134, 135
 - elements, compatibility of, 107
 - errors, 100
 - evolution, 99
 - programming, 18
- signal flow, 135, 143
- single data element, 35, 36
- step, 84
 - action association, 91
 - activation, 100
 - activation, 99
 - active, 84, 85, 100
 - active, 95
 - deactivation, 84, 91, 99
 - duration, 100
 - elapsed time, 84, 85
 - flag, 84, 85
 - inactive, 84
 - initial, 84, 85, 99
 - initialization, 85
 - retentive, 85
 - state, 84, 99, 100, 105
- structured data type, 67
 - declaration, 32
 - initialization, 33
 - usage, 35
- structured variable, 38
 - assignment, 133
 - declaration, 42
 - initialization, 42
 - step elements, 84
- subscripting, 38
 - array initialization, 43
- symbolic representation, 36, 41

<http://www.china-gauges.com/>

synchronization
 interprocess, 134
 of function blocks, 114

syntax, 14
 documentation, 21
 step/transition, 100

task, 14, 114
 declaration, 110
 programming, 18

TIME data type, 30, 84, 85, 93
 default initial value, 34
 function blocks, 81
 functions, 64

time literal, 28

time of day
 data types, 30
 default initial value, 34
 functions, 64
 keywords, 29
 literals, 28

timer, 81

transition, 84, 86
 clearing, 99, 100
 clearing time, 100
 condition, 84, 86, 89, 99
 enabled, 99
 evaluation, 100
 priority, 100
 symbol, 99

type conversion
 functions, 53, 55

typed literals, 26

underline character, 23, 25, 53

unsigned integer, 135
 data types, 30

variable, 36
 declaration, 50, 69
 usage, 35

WAIT function, 89, 134

warm restart, 38

white space, 24

wired OR, 143

<http://www.china-gauges.com/>

BSI — British Standards Institution

BSI is the independent national body responsible for preparing British Standards. It presents the UK view on standards in Europe and at the international level. It is incorporated by Royal Charter.

Revisions

British Standards are updated by amendment or revision. Users of British Standards should make sure that they possess the latest amendments or editions.

It is the constant aim of BSI to improve the quality of our products and services. We would be grateful if anyone finding an inaccuracy or ambiguity while using this British Standard would inform the Secretary of the technical committee responsible, the identity of which can be found on the inside front cover. Tel: +44 (0)20 8996 9000. Fax: +44 (0)20 8996 7400.

BSI offers members an individual updating service called PLUS which ensures that subscribers automatically receive the latest editions of standards.

Buying standards

Orders for all BSI, international and foreign standards publications should be addressed to Customer Services. Tel: +44 (0)20 8996 9001. Fax: +44 (0)20 8996 7001. Email: orders@bsi-global.com. Standards are also available from the BSI website at <http://www.bsi-global.com>.

In response to orders for international standards, it is BSI policy to supply the BSI implementation of those that have been published as British Standards, unless otherwise requested.

Information on standards

BSI provides a wide range of information on national, European and international standards through its Library and its Technical Help to Exporters Service. Various BSI electronic information services are also available which give details on all its products and services. Contact the Information Centre. Tel: +44 (0)20 8996 7111. Fax: +44 (0)20 8996 7048. Email: info@bsi-global.com.

Subscribing members of BSI are kept up to date with standards developments and receive substantial discounts on the purchase price of standards. For details of these and other benefits contact Membership Administration. Tel: +44 (0)20 8996 7002. Fax: +44 (0)20 8996 7001. Email: membership@bsi-global.com.

Information regarding online access to British Standards via British Standards Online can be found at <http://www.bsi-global.com/bsonline>.

Further information about BSI is available on the BSI website at <http://www.bsi-global.com>.

Copyright

Copyright subsists in all BSI publications. BSI also holds the copyright, in the UK, of the publications of the international standardization bodies. Except as permitted under the Copyright, Designs and Patents Act 1988 no extract may be reproduced, stored in a retrieval system or transmitted in any form or by any means – electronic, photocopying, recording or otherwise – without prior written permission from BSI.

This does not preclude the free use, in the course of implementing the standard, of necessary details such as symbols, and size, type or grade designations. If these details are to be used for any other purpose than implementation then the prior written permission of BSI must be obtained.

Details and advice can be obtained from the Copyright & Licensing Manager. Tel: +44 (0)20 8996 7070. Fax: +44 (0)20 8996 7553. Email: copyright@bsi-global.com.