

Low-voltage switchgear and controlgear —

Part 5-9: Control circuit devices and
switching elements — Flow rate
switches

<http://www.china-gauges.com/>

ICS 29.130.20

National foreword

This British Standard is the UK implementation of EN 60947-5-9:2007. It is identical to IEC 60947-5-9:2006.

The UK participation in its preparation was entrusted by Technical Committee PEL/17, Switchgear, controlgear, and HV-LV co-ordination, to Subcommittee PEL/17/2, Low voltage switchgear and controlgear.

A list of organizations represented on this committee can be obtained on request to its secretary.

This publication does not purport to include all the necessary provisions of a contract. Users are responsible for its correct application.

Compliance with a British Standard cannot confer immunity from legal obligations.

<http://www.china-gauges.com/>

This British Standard was published under the authority of the Standards Policy and Strategy Committee on 31 January 2008

© BSI 2008

ISBN 978 0 580 61338 8

Amendments/corrigenda issued since publication

Date	Comments

English version

**Low-voltage switchgear and controlgear -
Part 5-9: Control circuit devices and switching elements -
Flow rate switches**

(IEC 60947-5-9:2006)

Appareillage à basse tension -
Partie 5-9: Appareils et éléments
de commutation pour circuit
de commande -
DéTECTEURS DE DÉBIT
(CEI 60947-5-9:2006)

Niederspannungsschaltgeräte -
Teil 5-9: Steuergeräte und
Schaltelemente -
Durchflussmengenschalter
(IEC 60947-5-9:2006)

This European Standard was approved by CENELEC on 2007-09-01. CENELEC members are bound to comply with the CEN/CENELEC Internal Regulations which stipulate the conditions for giving this European Standard the status of a national standard without any alteration.

Up-to-date lists and bibliographical references concerning such national standards may be obtained on application to the Central Secretariat or to any CENELEC member.

This European Standard exists in three official versions (English, French, German). A version in any other language made by translation under the responsibility of a CENELEC member into its own language and notified to the Central Secretariat has the same status as the official versions.

CENELEC members are the national electrotechnical committees of Austria, Belgium, Bulgaria, Cyprus, the Czech Republic, Denmark, Estonia, Finland, France, Germany, Greece, Hungary, Iceland, Ireland, Italy, Latvia, Lithuania, Luxembourg, Malta, the Netherlands, Norway, Poland, Portugal, Romania, Slovakia, Slovenia, Spain, Sweden, Switzerland and the United Kingdom.

CENELEC

European Committee for Electrotechnical Standardization
Comité Européen de Normalisation Electrotechnique
Europäisches Komitee für Elektrotechnische Normung

Central Secretariat: rue de Stassart 35, B - 1050 Brussels

Foreword

The text of document 17B/1500/FDIS, future edition 1 of IEC 60947-5-9, prepared by SC 17B, Low-voltage switchgear and controlgear, of IEC TC 17, Switchgear and controlgear, was submitted to the IEC-CENELEC parallel vote and was approved by CENELEC as EN 60947-5-9 on 2007-09-01.

This standard is to be used in conjunction with EN 60947-1:2004 and EN 60947-5-2:1998.

The provisions of the general rules, EN 60947-1, are applicable to this part of EN 60947, where specifically called for. General rules clauses and subclauses thus applicable, as well as tables, figures and annexes are identified by a reference to IEC 60947-1, for example 1.2.3 or Annex A of IEC 60947-1.

The following dates were fixed:

- latest date by which the EN has to be implemented at national level by publication of an identical national standard or by endorsement (dop) 2008-06-01
- latest date by which the national standards conflicting with the EN have to be withdrawn (dow) 2010-09-01

This European Standard has been prepared under a mandate given to CENELEC by the European Commission and the European Free Trade Association and covers essential requirements of EC Directive EMC (2004/108/EC). See Annex ZZ.

Annexes ZA and ZZ have been added by CENELEC.

Endorsement notice

The text of the International Standard IEC 60947-5-9:2007 was approved by CENELEC as a European Standard without any modification.

CONTENTS

1	General	5
1.1	Scope and object	5
1.2	Normative references	5
2	Terms and definitions	6
2.1	Basic definitions	7
2.2	Characteristics of a flow rate switch	8
2.3	Delay times	9
3	Classification	9
3.1	General	9
3.2	Classification according to sensing means	10
3.3	Classification according to the construction form	10
3.4	Classification according to the switching element function	10
3.5	Classification according to the type of output	10
3.6	Classification according to the method of connection	10
4	Characteristics	10
4.1	Summary of characteristics	10
4.2	Operating conditions	10
4.3	Rated and limiting values for the flow rate switch	11
4.4	Utilization categories for the switching element	13
5	Product information	13
5.1	Nature of information	13
5.2	Marking	13
5.3	Instruction for installation, operation and maintenance	14
6	Normal service, mounting and transport conditions	14
6.1	Normal service conditions	14
6.2	Conditions during transport and storage	15
6.3	Mounting	15
6.4	Indicating means	15
7	Constructional and performance requirements	15
7.1	Constructional requirements	15
7.2	Performance requirements	17
7.3	Shock and vibration	23
8	Tests	23
8.1	Kinds of tests	24
8.2	Compliance with constructional requirements	24
8.3	Performance	24
8.4	Verification of set point and delay times	31
8.5	Verification of the electromagnetic compatibility	32
8.6	Test results and test report	34

Annex ZA (normative) Normative references to international publications with their corresponding European publications 35

Annex ZZ (informative) Coverage of Essential Requirements of EC Directives 37

Figure 1 – Relationship between operating points of a flow rate switch..... 11

Figure 2 – Relationship between U_e and U_B 11

Figure 3 – Test circuit for the verification of time delay before availability..... 27

Figure 4 – Signal output across load in Figure 3 27

Figure 5 – Test circuit for the verification of minimum operational current OFF-state current, voltage drop and independent stop action 28

Figure 6 – Short-circuit testing 31

Figure 7 – Testing set point and delay times..... 32

Table 1 – Classification of flow rate switches 9

Table 2 – Acceptance criteria 21

Table 3 – Immunity tests 22

<http://www.china-gauges.com/>

LOW-VOLTAGE SWITCHGEAR AND CONTROLGEAR –

Part 5-9: Control circuit devices and switching elements – Flow rate switches

1 General

1.1 Scope and object

This part of IEC 60947 applies to flow rate switches that sense the rate of flow of a gas, a liquid or a granular solid. These switches change their output state if a pre-set value for the speed of flow is exceeded.

These flow rate switches are self-contained, have semiconductor switching element(s) and are intended to be connected to circuits, the rated voltage of which does not exceed 250 V 50 Hz/60 Hz a.c. or 300 V d.c.

This standard does not specify the additional measures that are necessary for flow rate switches used in conjunction with explosive sensing materials and/or in an explosive location.

This standard is not intended to cover devices with analogue outputs.

The object of this standard is to state for flow rate switches:

- definitions;
- classifications;
- characteristics;
- product information;
- normal service, mounting and transport conditions;
- constructional and performance requirements;
- tests to verify rated characteristics.

1.2 Normative references

The following referenced documents are indispensable for the application of this document. For dated references, only the edition cited applies. For undated references, the latest edition of the referenced document (including any amendments) applies.

IEC 60446:1999, *Basic and safety principles for man-machine interface, marking and identification – Identification of conductors by colours or numerals*

IEC 60947-1:2004, *Low-voltage switchgear and controlgear – Part 1: General rules*

IEC 60947-5-2:1997, *Low-voltage switchgear and controlgear – Part 5-2: Control circuit devices and switching elements – Proximity switches*

Amendment 1 (1999)

Amendment 2 (2003)

IEC 61000-3-2:2005, *Electromagnetic compatibility (EMC) – Part 3-2: Limits – Limits for harmonic current emissions (equipment input current ≤ 16 A per phase)*

IEC 61000-3-3:1994, *Electromagnetic compatibility (EMC) – Part 3-3: Limits – Limitation of voltage changes, voltage fluctuations and flicker in public low-voltage supply systems for equipment with rated current ≤ 16 A per phase and not subject to conditional connection*

Amendment 1 (2001)

Amendment 2 (2005)

IEC 61000-4-2:1995, *Electromagnetic compatibility (EMC) – Part 4-2: Testing and measurement techniques – Electrostatic discharge immunity test*

Amendment 1 (1998)

Amendment 2 (2000)

IEC 61000-4-3:2006, *Electromagnetic compatibility (EMC) – Part 4-3: Testing and measurement techniques – Radiated, radio-frequency, electromagnetic field immunity test*

IEC 61000-4-4:2004, *Electromagnetic compatibility (EMC) – Part 4-4: Testing and measurement techniques – Electrical fast transient/burst immunity test*

IEC 61000-4-6:2003, *Electromagnetic compatibility (EMC) – Part 4-6: Testing and measurement techniques – Immunity to conducted disturbances, induced by radio-frequency fields*

Amendment 1 (2004)

Amendment 2 (2006)

IEC 61000-4-8:1993, *Electromagnetic compatibility (EMC) – Part 4-8: Testing and measurement techniques – Power frequency magnetic field immunity test*

Amendment 1 (2000)

IEC 61000-4-11:2004, *Electromagnetic compatibility (EMC) – Part 4-11: Testing and measurement techniques – Voltage dips, short interruptions and voltage variations immunity tests*

IEC 61000-4-13:2002, *Electromagnetic compatibility (EMC) – Part 4-13: Testing and measurement techniques – Harmonics and interharmonics including mains signalling at a.c. power port, low-frequency immunity tests*

IEC 61140:2001, *Protection against electric shock – Common aspects for installation and equipment*

Amendment 1 (2004)

IEC 61558-2-6, *Safety of power transformers, power supply units and similar – Part 2: Particular requirements for safety isolating transformers for general use*

CISPR 11:2003, *Industrial, scientific and medical (ISM) radio-frequency equipment – Electromagnetic disturbance characteristics – Limits and methods of measurement*

Amendment 1 (2004)

2 Terms and definitions

For the purposes of this document, the relevant definitions given in Clause 2 of IEC 60947-1 and Clause 2 of IEC 60947-5-2 apply with the following additional definitions.

Alphabetical index of definitions

	Reference
A	
Active zone.....	2.2.1
Adjuster (for a flow rate switch).....	2.2.4
F	
Flow direction	2.1.6
Flow rate sensor.....	2.1.2
Flow rate switch.....	2.1.1
H	
Homogenization zone	2.1.7
Hysteresis (<i>H</i>).....	2.2.8
M	
Maximum temperature gradient.....	2.2.9
Medium	2.1.4
R	
Reference medium.....	2.1.5
Repeat accuracy (<i>R</i>).....	2.2.7
S	
Semiconductor switching element	2.1.3
Sensing range	2.2.6
Sensor tip.....	2.2.2
Set point (s_s)	2.2.5
Submersion depth.....	2.2.3
T	
Time delay before availability (t_v)	2.3.3
Turn-off time.....	2.3.2
Turn-on time	2.3.1

2.1 Basic definitions

2.1.1

flow rate switch

device consisting of a flow rate sensor and a switching element which, in accordance with an increasing or decreasing flow of a defined medium (flow medium), changes the output signal at a predetermined value

2.1.2**flow rate sensor**

transducer which detects the rate of flow of a medium in an active area

2.1.3**semiconductor switching element**

element designed to switch the current in an electric circuit by controlling the conductivity of a semiconductor

2.1.4**medium**

gaseous, liquid, or fine granular solid, or a combination thereof

2.1.5**reference medium**

medium with which measurements according to this standard are made

2.1.6**flow direction**

direction from which the medium flows towards the sensor

2.1.7**homogenization zone**

zone in front of and behind the sensor with undisturbed flow necessary to homogenize the flow of the medium in order to obtain correct measurement results

2.2 Characteristics of a flow rate switch**2.2.1****active zone**

zone in which a flow rate is detected

NOTE This can be, for example the surface of the sensor tip or inner surface of a sensor tube.

2.2.2**sensor tip**

tip which is surrounded by the medium to sense the flow speed

2.2.3**submersion depth**

minimum length of the sensor tip that needs to be surrounded by the medium to obtain correct measurement results

2.2.4**adjuster (for a flow rate switch)**

part of a flow rate switch used to set the operating parameters

NOTE This may be a potentiometer, a push-button and/or a data interface.

2.2.5**set point**

s_s

rate of flow of the medium at which the switching element changes its state

2.2.6**sensing range**

range between a minimum and a maximum rate of flow within which the set point can be adjusted

2.2.7

repeat accuracy

R

value of variation of the set point under specified conditions

2.2.8

hysteresis

H

difference between the set points at which the switching element turns on and turns off

2.2.9

maximum temperature gradient

maximum specified value of a temperature change of the medium at constant rate within a specified time that does not lead to a change of state of the switching element

2.3 Delay times

2.3.1

turn-on time

time required for the semiconductor switching element to respond after the measured input variable has exceeded the set point under specified conditions

2.3.2

turn-off time

time required for the semiconductor switching element to respond after the measured input variable has fallen below the set point under specified conditions

2.3.3

time delay before availability

t_v

time between the switching on of the supply voltage and the instant at which the flow rate switch becomes ready to operate correctly

3 Classification

3.1 General

Flow rate switches are classified according to various general characteristics as shown in Table 1.

Table 1 – Classification of flow rate switches

1 st position/ 1 digit	2 nd position/ 1 digit	3 rd position/ 1 digit	4 th position/ 1 digit	5 th position/ 1 digit
Sensing means	Construction form	Switching element function (output)	Type of output	Method of connection
3.2	3.3	3.4	3.5	3.6
F Flow	1 One sensor tip 2 Two sensor tips 3 Flush with tube	A NO (make) B NC (break) C Changeover (make – break) P Programmable by user S Other	P PNP output, 3 or 4 terminal d.c. N NPN output, 3 or 4 terminal d.c. A 3 or 4 terminal a.c. B Bus interface S Other	1 Integral leads 2 Integral connector 3 Screw terminal 9 Other

3.2 Classification according to sensing means

In this standard the sensing means is designated by a capital letter placed in the first position.

3.3 Classification according to the construction form

The construction form is designated by a one-digit number placed in the second position.

3.4 Classification according to the switching element function

The switching element function is designated by a capital letter placed in the third position.

3.5 Classification according to the type of output

The type of output is designated by a capital letter placed in the fourth position.

3.6 Classification according to the method of connection

The method of connection is designated by a one-digit number placed in the fifth position.

4 Characteristics

4.1 Summary of characteristics

4.1.1 General

The characteristics of flow rate switches shall be stated in the following terms:

- Operating conditions (4.2)
- Rated and limiting values (4.3)
 - Rated voltages (4.3.1)
 - Currents (4.3.2)
 - Rated supply frequency (4.3.3)
 - Normal load and abnormal load characteristics (4.3.4)
 - Short-circuit characteristics (4.3.5)
- Utilisation categories for the switching element (4.4)

4.1.2 Operation of a flow rate switch

The output state is determined by

- the rate of flow in the active zone of the flow sensor, and
- the set point(s).

4.2 Operating conditions

4.2.1 Operating points of a flow rate switch

The relationship between the operating points is shown in Figure 1.

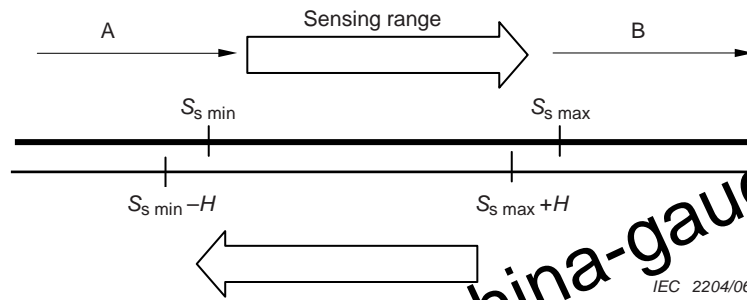

Key

- A range below lower limit of sensing range
- B range above upper limit of sensing range

Figure 1 – Relationship between operating points of a flow rate switch

4.2.2 Sensing range

Operating range values shall be stated by the manufacturer.

4.3 Rated and limiting values for the flow rate switch

4.3.1 Voltages

The flow rate switch is defined by the following rated voltages.

4.3.1.1 Rated operational voltage (U_e)

The rated operational voltage (U_e) (or range) shall not exceed 250 V a.c. or 300 V d.c.

NOTE The manufacturer may state a range between the limiting values which includes all the tolerances of U_e , this range shall be designated U_B .

The relationship between U_e and U_B is shown in Figure 2.

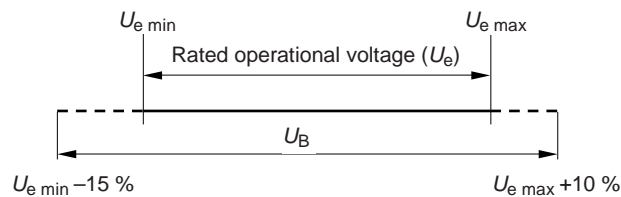

Figure 2 – Relationship between U_e and U_B

4.3.1.2 Rated insulation voltage (U_i)

The rated insulation voltage of a flow rate switch is the value of voltage to which the dielectric voltage tests and creepage distances are referred.

For flow rate switches, the rated insulation voltage shall be equal to or greater than the highest rated operational voltage.

4.3.1.3 Rated impulse withstand voltage (U_{imp})

Subclause 4.3.1.3 of IEC 60947-1 applies.

4.3.1.4 Voltage drop (U_d)

The voltage drop is the voltage measured across the active output of the flow rate switch when carrying the rated operational current under specified conditions. The values are specified in 7.2.1.13.

4.3.2 Currents

The switching element of a flow rate switch is defined by the following currents.

4.3.2.1 Rated operational current (I_e)

See 7.2.1.9.

4.3.2.2 Minimum operational current (I_m)

See 7.2.1.10.

4.3.2.3 OFF-state current (I_r)

See 7.2.1.11.

4.3.2.4 No-load supply current (I_o)

The maximum no-load supply current of a three- or four-terminal flow rate switch shall be stated by the manufacturer.

4.3.3 Rated supply frequency

The rated supply frequency for a.c. flow rate switches shall be 50 Hz and/or 60 Hz.

4.3.4 Normal load and abnormal load characteristics

4.3.4.1 Rated making and breaking capacities and behaviour of switching element under normal conditions

A semiconductor switching element shall comply with the requirements given in Table 4 of IEC 60947-5-2.

NOTE For a semiconductor switching element to which a utilization category is assigned, it is not necessary to specify separately a making and breaking capacity.

4.3.4.2 Making and breaking capacities under abnormal conditions

A semiconductor switching element shall comply with the requirements given in Table 5 of IEC 60947-5-2.

NOTE For a semiconductor switching element to which a utilization category is assigned, it is not necessary to specify separately a making and breaking capacity.

4.3.5 Short-circuit characteristics

The rated conditional short-circuit current of a flow rate switch is 100 A prospective. The flow rate switch shall withstand satisfactorily the test specified in 8.3.4.

4.4 Utilization categories for the switching element

The utilization categories as given in Table 2 of IEC 60947-5-2 are considered standard. Any other type of application shall be based on agreement between manufacturer and user, but information given in the manufacturer's documentation may constitute such an agreement.

5 Product information

5.1 Nature of information

The following information shall be given by the manufacturer.

Identification

- a) The manufacturer's name or trade mark.
- b) A type designation or other marking which makes it possible to identify the flow rate switch and get the relevant documentation from the manufacturer.
- c) Reference to this standard if the manufacturer claims compliance.

Basic rated values and utilization

- d) Rated operational voltage(s) (see 4.3.1.1).
- e) Utilization category and rated operational currents at the rated operational voltages and rated frequency/frequencies or at direct current, d.c. or reference to relevant specifications.
- f) Rated insulation voltage (see 4.3.1.2).
- g) Rated impulse withstand voltage (see 4.3.1.3).
- h) IP code (see 7.1.10).
- i) Pollution degree (see 6.1.4.2).
- j) Type and maximum ratings of short-circuit protective device (see 7.2.5).
- k) Rated conditional short-circuit current (see 4.3.5).
- l) Sensing range (see 7.2.1.3).
- m) Repeat accuracy (see 7.2.1.4).
- n) Hysteresis (see 7.2.1.5).
- o) Delay times (see 7.2.1.6).
- p) Minimum operational current (see 7.2.1.10).
- q) OFF-state current (see 7.2.1.11).
- r) No-load supply current (see 4.3.2.4).
- s) Voltage drop (see 7.2.1.13).
- t) Switching element function (see 2.4.1 of IEC 60947-5-2).
- u) Mounting arrangement.
- v) Physical dimensions.

5.2 Marking

5.2.1 General

Data under a) and b) of 5.1 shall be marked on the body of the flow rate switch or on a nameplate permanently attached to the product.

NOTE This requirement is intended to permit the complete information to be obtained from the manufacturer.

Marking shall be indelible and easily legible, and shall not be placed on parts normally removable in service. If the dimension of the housing of the flow rate switch is too small, the marking may be placed on the cord or on a tag permanently attached to the cord, located no further than 100 mm from the body of the device.

Data under c) to v) of 5.1, when not marked on the flow rate switch, shall be included in the manufacturer's documentation.

5.2.2 Terminal identification and marking

Subclause 7.1.7.4 applies.

5.2.3 Functional markings

The active area and the intended flow direction (if applicable) shall be marked when either the active area or the intended flow direction is not apparent by the construction of the flow rate switch.

5.3 Instruction for installation, operation and maintenance

The manufacturer shall specify in his documentation the conditions for installation, operation and maintenance of the flow rate switch.

The above documents shall indicate the recommended extent and frequency of maintenance, if any.

6 Normal service, mounting and transport conditions

6.1 Normal service conditions

6.1.1 General

Flow rate switches complying with this standard shall be capable of operating under the following standard conditions.

If the conditions for operation differ from those given in this standard, they shall be based on agreement between manufacturer and user, but information given in the manufacturer's documentation may constitute such an agreement.

6.1.2 Operating temperatures

6.1.2.1 Temperature of the medium

The rated temperature range of the medium shall be stated by the manufacturer.

6.1.2.2 Ambient air temperature

Flow rate switches shall operate between the ambient air temperatures of 0 °C and 60 °C. The operating characteristics shall be maintained over the permissible range of ambient temperature.

6.1.3 Altitude

Subclause 6.1.2 of IEC 60947-1 applies.

6.1.4 Climatic conditions

6.1.4.1 Humidity

The relative humidity (RH) of the air shall not exceed 95 %.

6.1.4.2 Pollution degree

Unless otherwise stated by the manufacturer, a flow rate switch is intended for installation under environmental conditions of pollution degree 3 as defined in 6.1.3.2 of IEC 60947-1. However, other pollution degrees may apply, depending upon the micro-environment.

6.2 Conditions during transport and storage

A special agreement shall be made between the user and the manufacturer if the conditions during transport and storage, e.g. temperature and humidity conditions, differ from those defined in 6.1.

6.3 Mounting

Mounting dimensions and conditions shall be stated by the manufacturer.

6.4 Indicating means

Flow rate switches may have one or more coloured indicating means. If applicable they shall have the following meaning:

- a) green (constant) power ON;
- b) yellow (constant) switching element ON;
- c) red (constant) failure indication;
- d) any other colour (constant) or one of the above mentioned colours (flashing): other functions (e.g. short-circuit indication).

7 Constructional and performance requirements

7.1 Constructional requirements

7.1.1 Materials

Subclause 7.1.1 of IEC 60947-5-2 applies.

7.1.2 Current-carrying parts and their connections

Subclause 7.1.2 of IEC 60947-1 applies.

7.1.3 Clearances and creepage distances

Subclause 7.1.3 of IEC 60947-1 applies.

7.1.4 Actuation

Flow rate switches are tested for operation by adjusting the rate of flow of a medium specified by the manufacturer across the set point for both increasing and decreasing flow rates.

7.1.5 Vacant**7.1.6 Vacant****7.1.7 Terminals****7.1.7.1 Constructional requirements**

Subclause 7.1.7.1 of IEC 60947-1 applies.

7.1.7.2 Connecting capacity

Subclause 7.1.7.2 of IEC 60947-1 applies.

7.1.7.3 Connection means

Subclause 7.1.7.3 of IEC 60947-1 applies with the following additions.

Flow rate switches may have integral connecting leads; in this case the outer sheath of the connecting leads shall be $2^{+0,1}_0$ m long.

7.1.7.4 Connection identification and marking

Subclause 7.1.7.4 of IEC 60947-1 applies with the following additions.

Flow rate switches with integral connecting leads shall have wires identified with colours according to Table 3 of IEC 60947-5-2.

The bicolour combination green-and-yellow shall be used for identifying the protective conductor and for no other purposes (see IEC 60446). The colour green and/or the colour yellow shall not be used where there is a possibility of confusion with the protective conductor.

7.1.8 Vacant**7.1.9 Provisions for protective earthing****7.1.9.1 Constructional requirements**

Subclause 7.1.9.1 of IEC 60947-1 applies with the following addition.

NOTE Flow rate switches with maximum rated voltages not exceeding either 50 V a.c. or 120 V d.c. need no provision for protective earthing.

Consideration should be given to the safety insulation of the supply and its transformer (if any). Where the supply is from a transformer, it should comply with IEC 61558-2-6.

7.1.9.2 Protective earth terminal

Subclause 7.1.9.2 of IEC 60947-1 applies.

7.1.9.3 Protective earth terminal marking and identification

Subclause 7.1.9.3 of IEC 60947-1 applies.

7.1.10 Degree of protection

The manufacturer shall state the degree of protection, verified in accordance with Annex C of IEC 60947-1.

7.1.11 Requirements for flow rate switches with integrally connected cables

See Annex C of IEC 60947-5-2.

7.1.12 Class II flow rate switches

These devices shall not be provided with means for protective earthing (see IEC 61140).

For class II flow rate switches insulated by encapsulation, see Annex B of IEC 60947-5-2.

7.2 Performance requirements

The following requirements apply to cleanable equipment.

7.2.1 Operating conditions

7.2.1.1 General

The equipment shall be mounted in accordance with the instructions given by the manufacturer.

For the tests of 7.2.1.3 through 7.2.1.6 the load shall be adjusted to provide $0,2 I_e$.

7.2.1.2 Operating limits

The flow rate switches shall operate satisfactorily

- a) between 85 % and 110 % of U_e , or
- b) between 85 % of $U_{e \min}$ and 110 % of $U_{e \max}$, or
- c) over the range U_B .

For d.c., the value of the ripple voltage (peak to peak) shall not exceed $0,1 U_e$ (see 4.3.1.1).

7.2.1.3 Sensing range

The sensing range is measured according to 8.4. The relationship between the set points is shown in Figure 1.

7.2.1.4 Repeat accuracy (R)

The repeat accuracy is measured over a period of 8 h at a temperature of the manufacturer's specified medium of $(23 \pm 5) ^\circ\text{C}$ and an ambient air temperature of $(23 \pm 5) ^\circ\text{C}$ at a relative humidity of any value in the range of 6.1.4.1, and at the rated supply voltage $\pm 5\%$.

The difference between any two measurements shall not exceed 10 % of the set point:

$$R \leq 0,1 s_s$$

7.2.1.5 Hysteresis (H)

The hysteresis is given as a percentage of the set point (s_s). The measurement is made at a temperature of the manufacturer's specified medium of $(23 \pm 5)^\circ\text{C}$ and an ambient air temperature of $(23 \pm 5)^\circ\text{C}$ at the rated supply voltage $\pm 5\%$. It shall be less than 20% of the set point (s_s):

$$H \leq 0,2 s_s$$

7.2.1.6 Time delay before availability (t_v) (start-up time)

The time delay before availability shall not exceed the value stated by the manufacturer.

During this time the switching element shall not give any false signal. A false signal is a signal other than zero which appears for longer than 2 ms (see 8.3.3.2.2).

7.2.1.7 Turn on time (t_{on})

The turn on time and the measuring method shall be stated by the manufacturer.

7.2.1.8 Turn off time (t_{off})

The turn off time and the measuring method shall be stated by the manufacturer.

7.2.1.9 Rated operational current (I_e)

The rated operational current shall be

- 50 mA d.c., or
- 200 mA a.c. r.m.s.

Greater values may be agreed upon between manufacturer and user, but information given in the manufacturer's documentation may constitute such an agreement.

7.2.1.10 Minimum operational current (I_m)

The minimum operational current shall be stated by the manufacturer.

7.2.1.11 OFF-state current (I_r)

The maximum current which flows through the load circuit of a flow rate switch in the OFF-state (I_r) shall be

- | | |
|------------------|--------------------------------------|
| 2 terminals | $I_r \leq 1,5 \text{ mA d.c., or}$ |
| | $I_r \leq 3 \text{ mA a.c. r.m.s.,}$ |
| 3 or 4 terminals | $I_r \leq 0,5 \text{ mA d.c.,}$ |

and verified according to 8.3.3.2.4.

NOTE See Table 3 of IEC 60947-5-2 for terminal details.

7.2.1.12 Switching element operation

The switching element operation shall be an independent action and shall be verified according to 8.3.3.2.5.

7.2.1.13 Voltage drop (U_d)

The voltage drop (U_d) measured according to 8.3.3.2.6 shall be

2 terminals	$U_d \leq 8 \text{ V d.c., or}$ $U_d \leq 10 \text{ V a.c. r.m.s.,}$
3 or 4 terminals	$U_d \leq 3,5 \text{ V d.c.}$

NOTE See Table 3 of IEC 60947-5-2 for terminal details.

7.2.2 Temperature rise

Subclause 7.2.2 of IEC 60947-1 applies with the following additions.

The temperature rise limit for flow rate switches is 50 K. This temperature rise applies for the exterior of the enclosure, metallic or non-metallic materials, and for terminals.

7.2.3 Dielectric properties

7.2.3.1 General

The flow rate switch shall be capable of withstanding the dielectric tests specified in 8.3.3.4.

For class II flow rate switches insulated by encapsulation, see Annex B of IEC 60947-5-2.

7.2.3.2 Impulse voltage withstand

The minimum test voltage shall be 1 kV.

The characteristics of the impulse generator are: 1,2/50 μs impulse; source impedance: 500 Ω ; source energy: 0,5 J.

7.2.4 Ability to make and break under normal load and abnormal load conditions

7.2.4.1 Making and breaking capacities

a) Making and breaking capacities under normal conditions

The switching elements shall be capable of making and breaking currents without failure under the conditions stated in Table 4 of IEC 60947-5-2, for the relevant utilization categories and the number of operations indicated, under the conditions specified in 8.3.3.5.

b) Making and breaking capacities under abnormal conditions

The switching elements shall be capable of making and breaking currents without failure under the conditions stated in Table 5 of IEC 60947-5-2, for the relevant utilization categories and the number of operations under the conditions specified in 8.3.3.5.

7.2.5 Conditional short-circuit current

The switching element shall withstand the stresses resulting from short-circuit currents under conditions specified in 8.3.4.

7.2.6 Electromagnetic compatibility (EMC)

7.2.6.1 General

The operating characteristics of the flow rate switch shall be maintained at all levels of electromagnetic interferences (EMI) up to and including the maximum level stated by the manufacturer.

Due to the protected application environment of flow rate switches, the immunity levels specified in this standard deviate, in some cases, from those specified in generic immunity standards.

The flow rate switch to be tested shall have all the essential design details of the type which it represents and shall be in a clean and new condition.

Maintenance or replacement of parts during or after a testing cycle is not permitted.

Two sets of environmental conditions are considered and are referred to as

- a) environment A,
- b) environment B.

Environment A relates to low-voltage non-public or industrial networks/locations/installations including highly disturbing sources.

NOTE 1 Environment A corresponds to equipment Class A in CISPR 11.

Environment B relates to low-voltage public networks such as domestic, commercial and light industrial locations/installations. Highly disturbing sources such as arc welders are not covered by this environment.

NOTE 2 Environment B corresponds to equipment Class B in CISPR 11.

7.2.6.2 Immunity

7.2.6.2.1 Acceptance criteria

Table 2 gives the acceptance criteria.

Table 2 – Acceptance criteria

Item	Acceptance criteria (performance criteria during tests)		
	A	B	C
Overall performance	No noticeable changes of the operating characteristic. Operating as intended ^a	During the tests the state of the switching element shall not change for more than 1 ms for d.c. devices and one cycle of supply frequency for a.c. devices	Temporary degradation or loss of performance which requires operator intervention or system reset
Operation of displays and signalling components	No changes to visible display information. Only slight light intensity fluctuation of LEDs, or slight movement of characters	Temporary visible changes or loss of information. Undesired LED illumination	Shut down. Permanent loss of display or wrong information. Unpermitted operating mode. Not self-recoverable
Information processing and sensing functions	Undisturbed communication and data interchange to external devices remains within the specification	Temporarily disturbed communication, which is detected and is self-recoverable	Erroneous processing of information. Undetected loss of data and/or information. Errors in communication. Not self-recoverable
^a The manufacturer shall state in his literature the operating frequency and bandwidth where conducted radio frequencies can cause malfunction.			

7.2.6.2.2 Electrostatic discharges

In accordance with IEC 61000-4-2 and Table 3.

The test voltage shall be applied using the contact discharge method to devices with metallic enclosures.

The test voltage shall be applied using the air gap discharge method to devices with non-metallic enclosures.

Table 3 – Immunity tests

Type of test	Test level required	Acceptance criteria
Electrostatic discharges IEC 61000-4-2	8 kV / air discharge or 4 kV / contact discharge	B
Radiated radio-frequency electromagnetic fields (80 MHz to 1 GHz and 1,4 GHz to 2 GHz) IEC 61000-4-3	10 V/m	A
Electrical fast transients/bursts IEC 61000-4-4	2 kV / 5 kHz	B
Conducted disturbances induced by radio-frequency fields (150 kHz to 80 MHz) IEC 61000-4-6		A
Power-frequency magnetic fields ^a IEC 61000-4-8	30 A/m	A
Voltage dips ^b IEC 61000-4-11	0 % of U_e during 0,5 cycle and 1 cycle ^c 70 % of U_e during 25/30 cycles ^e	B
Voltage interruptions ^b IEC 61000-4-11	0 % of U_e during 250/300 cycles ^{c e}	B
Harmonics in the supply IEC 61000-4-13	No requirements ^d	–
<p>^a Applicable only to flow rate switches containing devices susceptible to magnetic fields.</p> <p>^b Applicable only to a.c. flow rate switches; EMC environment Class 2 is applicable.</p> <p>^c 0 % means 0 V.</p> <p>^d Test levels are under study for the future.</p> <p>^e The value before the solidus (/) is for 50 Hz and the value behind for 60 Hz.</p>		

7.2.6.2.3 Radiated radio-frequency electromagnetic fields

In accordance with IEC 61000-4-3 and Table 3.

7.2.6.2.4 Electrical fast transients/bursts

In accordance with IEC 61000-4-4 and Table 3.

7.2.6.2.5 Surges

For flow rate switches, it is not necessary to test for surge immunity. The operating environment of these devices is considered to be well protected against surge voltages caused by lightning strikes.

7.2.6.2.6 Conducted disturbances induced by radio-frequency fields

In accordance with IEC 61000-4-6 and Table 3.

7.2.6.2.7 Power-frequency magnetic fields

In accordance with IEC 61000-4-8 and Table 3.

NOTE See Annex E of IEC 60947-5-2 for strong magnetic fields.

7.2.6.2.8 Voltage dips and interruptions

In accordance with IEC 61000-4-11 and Table 3.

7.2.6.2.9 Harmonics in the supply

In accordance with IEC 61000-4-13 and Table 3.

7.2.6.3 Emission

7.2.6.3.1 Conditions during measurement

The measurement shall be made in the operating mode, including grounding conditions, producing the highest emission in the frequency range being investigated which is consistent with normal applications (see Clause 4).

Each measurement shall be performed in defined and reproducible conditions.

Descriptions of the tests, test methods and set-ups are given in CISPR 11. The contents of this standard are not reproduced here; however, modifications or additional information needed for the practical application of the tests are given in this standard.

Flow rate switches which are intended to be powered by public mains supply, therefore within the scope of IEC 61000-3-2 and IEC 61000-3-3 regarding low frequency emission, shall also comply with the requirements of these standards.

7.2.6.3.2 Limits for high frequency emissions

Flow rate switches can generate continuous electromagnetic disturbances.

Such emissions shall not exceed the limits given in CISPR 11 for class A equipment (group 1). These tests are only required when the control and/or auxiliary circuits contain components with fundamental switching frequencies greater than 9 kHz.

7.2.6.3.3 Limits for low frequency emissions

For flow rate switches which generate low frequency harmonics, the requirements of IEC 61000-3-2 apply.

For flow rate switches which generate low frequency voltage fluctuations, the requirements of IEC 61000-3-3 apply.

NOTE These requirements are not required for devices that will not be connected to public mains.

7.3 Shock and vibration

Subclause 7.4 of IEC 60947-5-2 applies.

8 Tests

Unless otherwise stated, the tests shall be carried out at an ambient air temperature and medium temperature of (23 ± 5) °C.

8.1 Kinds of tests

8.1.1 General

Subclause 8.1.1 of IEC 60947-1 applies.

8.1.2 Type tests

Type tests are intended to verify compliance of the design of fuse-rated switches with this standard.

This comprises the following verifications:

- a) temperature rise (8.3.3.3);
- b) dielectric properties (8.3.3.4);
- c) making and breaking capacities of switching elements under abnormal and normal conditions (8.3.3.5);
- d) performance under conditional short-circuit current (8.3.4);
- e) constructional requirements (8.2);
- f) degree of protection (8.2);
- g) sensing range (8.4);
- h) electromagnetic compatibility (8.5);
- i) shock withstandability (7.3);
- j) vibration withstandability (7.3).

8.1.3 Routine tests

Routine tests are the responsibility of the manufacturer and are usually limited to the mechanical inspection and verification of electrical operation.

The inspection shall be supplemented by a dielectric test which is carried out according to 8.3.3.4, the test duration may be reduced to 1 s.

8.1.4 Sampling tests

Subclause 8.1.4 of IEC 60947-1 applies.

8.1.5 Special tests

These tests are subject to agreement between manufacturer and user.

8.2 Compliance with constructional requirements

Subclause 8.2 of IEC 60947-1 applies where applicable.

8.3 Performance

8.3.1 Test sequences

The type and sequence of tests to be performed on five representative samples are as follows:

Sample No. 1

Test No. 1 – temperature rise (8.3.3.3).

Test No. 2 – mechanical properties of terminals (8.2.4 of IEC 60947-1).

Test No. 3 – dielectric properties (8.3.3.4).

Test No. 4 – visual inspection.

Sample No. 2

Test No. 1 – degree of protection (Annex C of IEC 60947-1)

Test No. 2 – vibration (7.3).

Test No. 3 – sensing range (8.4).

Test No. 4 – dielectric properties (8.3.3.4)

Sample No. 3

Test No. 1 – degree of protection (Annex C of IEC 60947-1).

Test No. 2 – shock (7.3).

Test No. 3 – sensing range (8.4).

Test No. 4 – dielectric properties (8.3.3.4).

Sample No. 4

Test No. 1 – making and breaking capacities (8.3.3.5).

Test No. 2 – dielectric properties (8.3.3.4).

Test No. 3 – sensing range (8.4).

Sample No. 5

Test No. 1 – electromagnetic compatibility (8.5).

Test No. 2 – performance under short-circuit conditions (8.3.4).

Test No. 3 – dielectric properties (8.3.3.4).

Test No. 4 – sensing range (8.4).

There shall be no failure of any of the above tests.

NOTE 1 More than one test sequence or all test sequences may be conducted on one sample at the request of the manufacturer. However, the test should be conducted in the sequence given above for each sample.

NOTE 2 For Class II flow rate switches insulated by encapsulation, additional samples are required (see Annex B of IEC 60947-5-2). For flow rate switches with integrally connected cables, additional samples are required (see Annex C of IEC 60947-5-2).

8.3.2 General test conditions

8.3.2.1 General requirements

Subclause 8.3.2.1 of IEC 60947-1 applies unless otherwise specified, with the following addition:

The following shall be used as the reference medium:

- a) for liquids: non gaseous water;
- b) for gases: air;
- c) for granular solids: to be stated by the manufacturer.

8.3.2.2 Test quantities

Subclause 8.3.2.2 of IEC 60947-1 applies except for 8.3.2.2.3.

8.3.2.3 Evaluation of test result

The condition of the flow rate switch after each test shall be checked by the verification applicable to each test.

The flow rate switch is deemed to have met the requirements of this standard if it meets the requirements of each test and/or test sequence as applicable.

8.3.2.4 Test report

Subclause 8.3.2.4 of IEC 60947-1 applies.

8.3.3 Performance under no load, normal load and abnormal load condition

8.3.3.1 Operation

Subclause 8.3.3.1 of IEC 60947-1 applies.

8.3.3.2 Operating limits

8.3.3.2.1 General

Operational voltages are defined under 7.2.1.2.

8.3.3.2.2 Time delay before availability

The test is performed with the flow rate switch connected to a test circuit shown in Figure 3.

The medium is put in a state such that the switching element is first in the ON-state and then in the OFF-state. With rated operational voltage U_e , or with the minimum value of the rated operational voltage when it is given as a range, the load is adjusted to obtain the minimum operational current I_m .

The time delay before availability and the duration of any false signal are measured by recording the signal across the load with an oscilloscope as the bounce-free "Switch" is closed. Figure 4 shows typical oscillograms for a d.c. switching element. Figure 4a shows the oscillogram when the switching element is in the ON-state and Figure 4b shows the oscillogram when the switching element is in the OFF-state.

The medium is adjusted to a state 200 % above the set point or 66 % below the set point minus hysteresis.

The measured time delay before availability, the time between t_3 and t_0 in Figure 4, shall be according to 7.2.1.6. The duration of the false signal, if any, the time between t_2 and t_1 in Figures 4a and 4b, shall be according to 7.2.1.6.

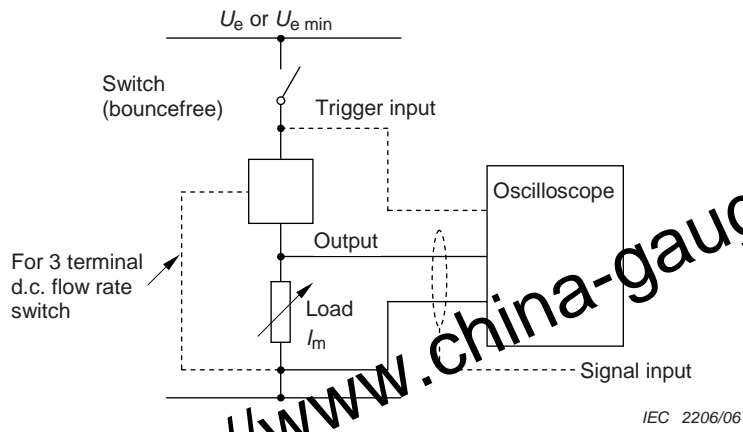

Figure 3 – Test circuit for the verification of time delay before availability

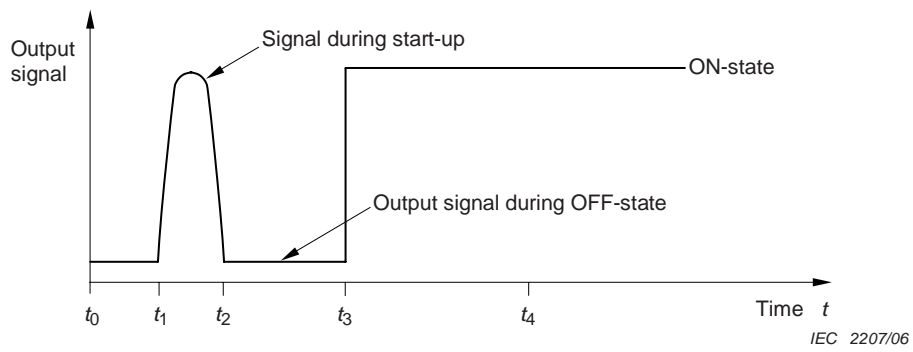

Figure 4a – Switching element is in the ON-state

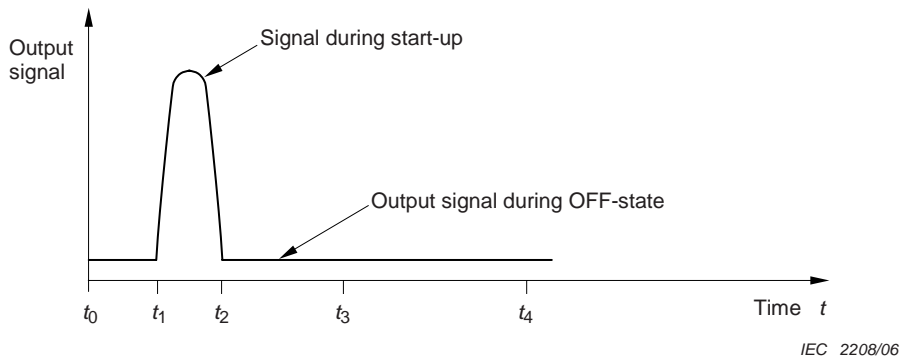

Figure 4b – Switching element is in the OFF-state

Key

- t_0 supply is switched on
- t_1 beginning of signal during start-up (if any)
- t_2 end of signal during start-up (if any)
- t_3 end of time delay
- t_4 maximum time for delay stated by the manufacturer

NOTE 1 The signal during start-up (if any) may begin at t_0 , which means that t_0 and t_1 are the same time marks.

NOTE 2 In case of no signal during start-up, the time mark t_3 may have any position between t_0 and t_4 .

NOTE 3 The waveform of the signal during start-up (if any) is stated by the manufacturer.

Figure 4 – Output signal across load in Figure 3

8.3.3.2.3 Minimum operational current (I_m)

The test is performed with the flow rate switch connected to a test circuit as shown in Figure 5.

The medium is put in a state such that the switching element is in the ON-state. With supply voltage U_e and the switch S being open, the load R_1 is adjusted to obtain the current I_m . The measured value shall not exceed the value specified in 7.2.1.10. The switching element shall not change state during the test.

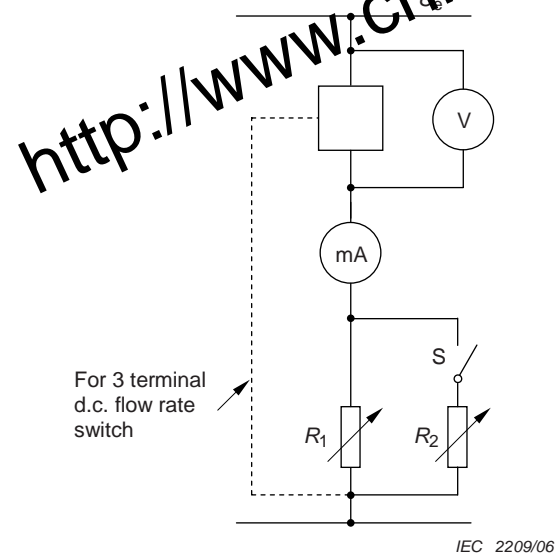

Key

R_1	resistive load	mA	milliammeter
R_2	resistive load	S	switch
V	high impedance voltmeter $\geq 0,2 \text{ M}\Omega/\text{V}$	Meters	r.m.s. for a.c. average for d.c.

Figure 5 – Test circuit for the verification of minimum operational current, OFF-state current, voltage drop and independent snap action

8.3.3.2.4 OFF-state current (I_r)

With the circuit as in Figure 5 and the switch S closed, the load R_2 is adjusted to obtain the rated operational current I_e when the supply voltage is the highest U_e . The medium is then put in a state such that the switching element is in the OFF-state.

The current I_r shall be measured with supply voltage $U_e + 10\%$ or with the maximum value of the supply voltage U_B where it is specified as a range. The current I_r shall not exceed the value specified in 7.2.1.11.

8.3.3.2.5 Independent (snap) action

Independent (snap) action shall be checked at maximum and minimum operating load currents at both maximum and minimum rated operating voltages. Resistive loads of appropriate value shall be used for each of the four tests.

These tests shall be carried out by changing the flow rate of the medium from a state where the switching element is in the OFF-state to a state where the switching element is in the ON-state and observing the output on an oscilloscope. The switching element function shall be substantially independent from the velocity of the change and the output shall switch between the ON and the OFF states without oscillating, or holding at any intermediate level.

8.3.3.2.6 Voltage drop (U_d)

The voltage drop is measured across the active outputs of the flow rate switch when the switching element is in the ON-state and carrying the rated operational current I_e at $(23 \pm 5)^\circ\text{C}$ ambient air temperature and at the lowest rated frequency. This measurement is performed with the circuit in Figure 5 and the switch S closed. The load R_2 is adjusted to obtain the rated operational current I_e with the supply voltage U_e . The voltage drop U_d is measured

- at $U_e +10\%$ and $U_e -15\%$,
- or $U_{e \max} +10\%$ and $U_{e \min} -15\%$,
- or $U_{B \max}$ and $U_{B \min}$.

The measured voltage drop shall not exceed the values specified in 7.2.1.13.

8.3.3.3 Temperature rise

The flow rate switch, installed as in normal service conditions, is supplied with its rated operational voltage U_e (or the highest operational voltage of its voltage range) and connected to a load corresponding to its rated operational current I_e until the thermal equilibrium is reached. The maximum difference between ambient air and medium temperature shall not exceed 3 K.

The temperature rise, measured on the terminals when applicable, and on any point of the enclosure shall not exceed 50 K (see 7.2.2 of IEC 60947-1).

The length of conductor connected to each terminal shall be $2_{-0,1}^0$ m.

8.3.3.4 Dielectric properties

8.3.3.4.1 General

The test for verifying dielectric properties shall be made

- in accordance with 8.3.3.4 of IEC 60947-1 for the rated impulse withstand voltage U_{imp} , and
- in accordance with 8.3.3.4.2, 8.3.3.4.3 and 8.3.3.4.4 of this standard.

For Class II flow rate switches insulated by encapsulation, see Annex B of IEC 60947-5-2.

8.3.3.4.2 Application of the test voltage

The test is to be carried out under circumstances approaching actual service conditions, e.g. with conductors attached. The external surface of all insulating parts likely to be touched in service shall be made conducting by being closely covered by a metal foil.

The flow rate switch shall be capable of withstanding the test voltage applied for 1 min for a type test, and 1 s for a routine test, with the following conditions:

- between live parts of the switching element and parts of the flow rate switch intended to be earthed;
- between live parts of the switching element and surfaces of the flow rate switch likely to be touched in service, conducting or made conducting by the metal foil;
- between live parts belonging to electrically separated switching elements, if any.

8.3.3.4.3 Value of the test voltage

A sinusoidal voltage of power frequency is applied according to 7.2.3.4.2. The test voltages are given in Table 6 of IEC 60947-5-2.

8.3.3.4.4 Results to be obtained

Subclause 8.3.3.4.3 of IEC 60947-5-2 applies.

8.3.3.4.5 Impulse voltage withstand test

The test is performed according to 7.2.3.2 with the following additional requirements:

- the flow rate switch is not powered during the test;
- the impulse voltage withstand test shall be applied
 - a) between all terminals connected together and earth,
 - b) between terminals intended to be connected to the power supply,
 - c) between each output terminal and each terminal intended to be connected to the power supply;
- three positive and three negative pulses shall be applied between each two points at intervals of not less than 5 s.

NOTE The impulse voltage withstand test is designed as a type test.

8.3.3.5 Making and breaking capacities

Subclause 8.3.3.5 of IEC 60947-5-2 applies.

8.3.4 Performance under short-circuit current conditions

8.3.4.1 Test circuit and test procedure

The flow rate switch (EUT) in new condition shall be mounted as in service, in free air, and connected to the test circuit with the same size wire as used in service, see Figure 6.

The short-circuit protective device (SCPD) shall be of the type and rating stated by the manufacturer. This SCPD shall be omitted if the flow rate switch is integrally protected against short-circuits.

The medium is put in a state such that the switching element is in the ON-state, R_1 is selected so that the current flowing through the flow rate switch is equal to its rated operational current. The supply S shall be adjusted to 100 A prospective short-circuit current. The SC switch, parallel with R_1 load, is intended to cause the short-circuit. The open-circuit voltage shall be 1,1 times the rated operational voltage or the maximum value of the voltage range.

The test shall be performed three times by randomly closing the "SC" switch. The test current is maintained until the SCPD or the internal short-circuit protection in the flow rate switch has operated. The interval between each of the three tests shall be not less than 3 min. The actual time between tests shall be stated in the test report. After each test, the SCPD shall be replaced or reset.

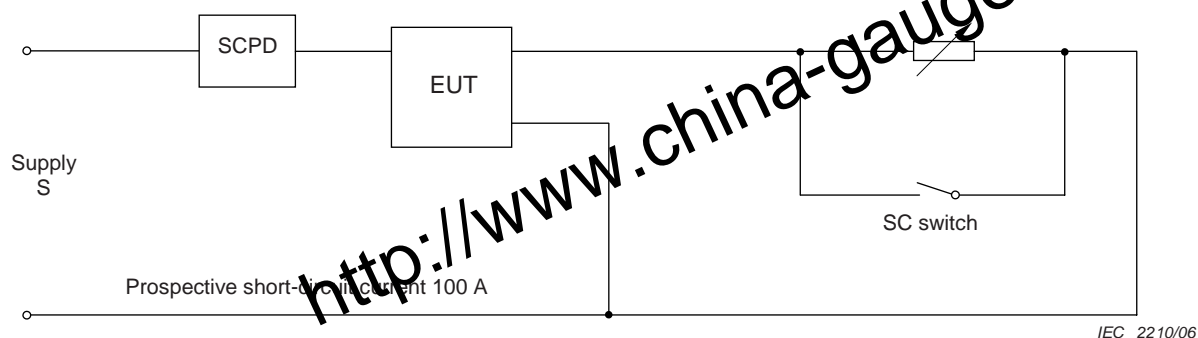

Figure 6 – Short-circuit testing

8.3.4.2 Results to be obtained

After the test, the set point of the flow rate switch shall be measured and shall remain within the limits given in 7.2.1.3.

8.4 Verification of set point and delay times

8.4.1 General

The tests shall be performed under the following conditions:

- The flow rate switch, mounted in normal service conditions according to the manufacturer's instructions in a test unit according to Figure 7, shall be connected to a load corresponding to the rated operational current I_e and supplied with its rated operational voltage U_e (or the maximum voltage of its voltage range).

The test shall be performed with the test unit (see Figure 7) adjusted

- to a flow rate 1 which is set to 10 % below the rated set point minus rated hysteresis, and
- to a flow rate 2 set to 10 % above the rated set point.

If the flow rate switch has an adjustable set point, the test shall be performed at the minimum flow rate, a typical flow rate and the maximum flow rate stated by the manufacturer.

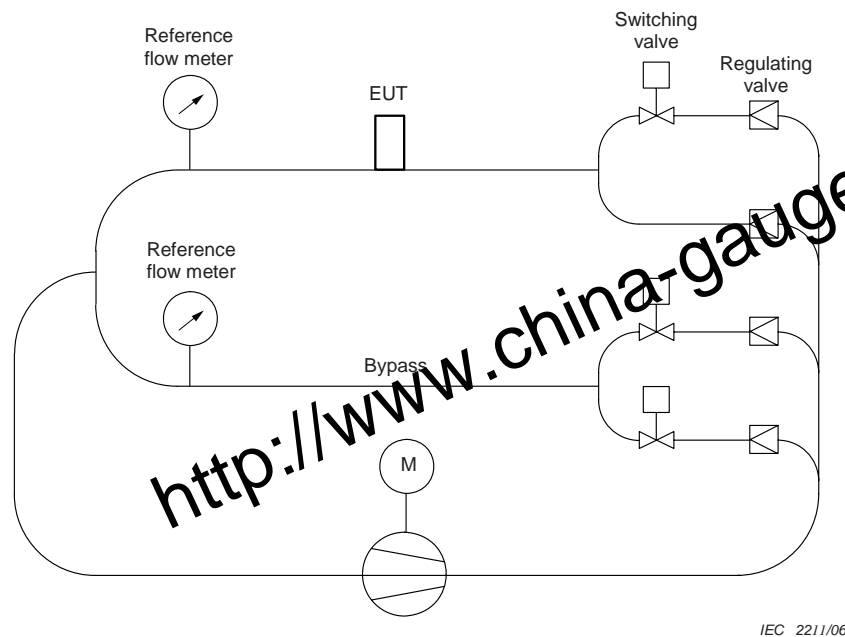

Figure 7 – Testing set point and delay times

8.4.2 Verification of the set point

The test is performed by changing from flow rate 1 to flow rate 2 and from flow rate 2 to flow rate 1 while observing the reaction of the flow rate switch.

The flow rate switch shall change its output state within the time stated by the manufacturer. The output shall switch between the ON and the OFF states without oscillating, or holding at any intermediate level.

8.4.3 Verification of the turn on delay time and the turn off delay time

The test is performed by changing from flow rate 1 to flow rate 2 and from flow rate 2 to flow rate 1 while observing the reaction of the flow rate switch.

The turn on delay time is the time that elapses between the change of flow rate 1 to flow rate 2 and the change of the output state of the flow rate switch.

The turn off delay time is the time that elapses between the change of flow rate 2 to flow rate 1 and the change of the output state of the flow rate switch.

8.5 Verification of the electromagnetic compatibility

8.5.1 General

The tests shall be performed under the following conditions:

- the flow rate switch mounted in normal service conditions shall be connected to a load corresponding to the rated operational current I_e and supplied with its rated operational voltage U_e (or the maximum voltage of its voltage range);
- the connecting leads shall be $2^{+0,1}_0$ m. For flow rate switches not having integral cables, the type of cable used shall be specified by the manufacturer and recorded in the test report.

The test shall be performed:

- a) with the medium put in a state such that the switching element is in the OFF-state;
- b) with the medium put in a state such that the switching element is in the ON-state.

For the test according to 8.5.3, the following additional mounting condition applies:

- the method of connection to the reference ground plane shall be in accordance with the manufacturer's instructions, if given, and shall be stated in the test report.

8.5.2 Immunity

8.5.2.1 Electrostatic discharges

The test shall be performed according to IEC 61000-4-2 and to 7.2.6.2.2, and shall be repeated 10 times at each measuring point, with a minimum time interval of 1 s between pulses.

8.5.2.2 Radiated radio-frequency electromagnetic fields

The test shall be performed according to IEC 61000-4-3 and 7.2.6.2.3.

8.5.2.3 Electrical fast transients/bursts

The test shall be performed according to IEC 61000-4-4, and to 7.2.6.2.4, with all the connecting leads placed in the capacitive coupling clamp.

8.5.2.4 Conducted disturbances induced by radio-frequency fields

The test shall be performed according to IEC 61000-4-6 and 7.2.6.2.6.

8.5.2.5 Power-frequency magnetic fields

The test shall be performed according to IEC 61000-4-8 and 7.2.6.2.7.

8.5.2.6 Voltage dips and interruptions

The test shall be performed according to IEC 61000-4-11 and 7.2.6.2.8.

8.5.3 Emission

The test shall be performed according to CISPR 11 Group 1, Class A, and 7.2.6.3.

These limits are given for devices exclusively built for an industrial environment (environment A). When they can be used in a domestic environment (environment B), the following notice shall be included in the instructions for use:

NOTICE

This is a Class A product. In a domestic environment this product may cause radio interference, in which case the user may be required to take adequate measures.

8.6 Test results and test report

The test results shall be documented in a comprehensive test report. The test report shall present the objective, the results and all relevant information of the tests. The test report shall define the flow rate switch under test, including the cable layout and the necessary auxiliary equipment. Any deviation from the test plan shall be mentioned.

Where a range of flow rate switches are made according to the same principle and design, and using the same type of components, tests may be performed on representative samples. Furthermore, based on first results, the testing laboratory may limit the tested frequency range for radiation or conduction tests and shall include in the report the frequency range used.

<http://www.china-gauges.com/>

Annex ZA (normative)

Normative references to international publications with their corresponding European publications

The following referenced documents are indispensable for the application of this document. For dated references, only the edition cited applies. For undated references, the latest edition of the referenced document (including any amendments) applies.

NOTE When an international publication has been modified by common modifications, indicated by (mod), the relevant EN/HD applies.

Publication	Year	Title	EN/HD	Year
IEC 60446	1999	Basic and safety principles for man-machine interface, marking and identification - Identification of conductors by colours or numerals	EN 60446	1999 ¹⁾
IEC 60947-1	2004	Low-voltage switchgear and controlgear - Part 1: General rules	EN 60947-1 + corr. November	2004 ²⁾ 2004
IEC 60947-5-2 (mod)	1997	Low-voltage switchgear and controlgear - Part 5-2: Control circuit devices and switching elements - Proximity switches	EN 60947-5-2	1998
A1	1999		A1	1999
A2	2003		A2	2004
IEC 61000-3-2	2005	Electromagnetic compatibility (EMC) - Part 3-2: Limits - Limits for harmonic current emissions (equipment input current ≤ 16 A per phase)	EN 61000-3-2	2006
IEC 61000-3-3	1994	Electromagnetic compatibility (EMC) - Part 3-3: Limits - Limitation of voltage changes, voltage fluctuations and flicker in public low-voltage supply systems, for equipment with rated current ≤ 16 A per phase and not subject to conditional connection	EN 61000-3-3 + corr. July	1995 1997
A1	2001		A1	2001
A2	2005		A2	2005
IEC 61000-4-2	1995	Electromagnetic compatibility (EMC) - Part 4-2: Testing and measurement techniques - Electrostatic discharge immunity test	EN 61000-4-2	1995
A1	1998		A1	1998
A2	2000		A2	2001
IEC 61000-4-3	2006	Electromagnetic compatibility (EMC) - Part 4-3: Testing and measurement techniques - Radiated, radio-frequency, electromagnetic field immunity test	EN 61000-4-3	2006
IEC 61000-4-4	2004	Electromagnetic compatibility (EMC) - Part 4-4: Testing and measurement techniques - Electrical fast transient/burst immunity test	EN 61000-4-4	2004
IEC 61000-4-6 + A1 + A2	2003 2004 2006	Electromagnetic compatibility (EMC) - Part 4-6: Testing and measurement techniques - Immunity to conducted disturbances, induced by radio-frequency fields	EN 61000-4-6 + corr. August	2007 2007

¹⁾ EN 60446:1999 is superseded by EN 60446:2007, which is based on IEC 60446:2007.

²⁾ EN 60947-1:2004 is superseded by EN 60947-1:2007, which is based on IEC 60947-1:2007.

<u>Publication</u>	<u>Year</u>	<u>Title</u>	<u>EN/HD</u>	<u>Year</u>
IEC 61000-4-8	1993	Electromagnetic compatibility (EMC) -	EN 61000-4-8	1993
A1	2000	Part 4-8: Testing and measurement techniques - Power frequency magnetic field immunity test	A1	2001
IEC 61000-4-11	2004	Electromagnetic compatibility (EMC) - Part 4-11: Testing and measurement techniques - Voltage dips, short interruptions and voltage variations immunity tests	EN 61000-4-11	2004
IEC 61000-4-13	2002	Electromagnetic compatibility (EMC) - Part 4-13: Testing and measurement techniques - Harmonics and interharmonics including mains signalling at a.c. power port, low frequency immunity tests	EN 61000-4-13	2002
IEC 61140	2001	Protection against electric shock - Common aspects for installation and equipment	EN 61140	2002
A1 (mod)	2004		A1	2006
IEC 61558-2-6	1997	Safety of power transformers, power supply units and similar - Part 2-6: Particular requirements for safety isolating transformers for general use	EN 61558-2-6	1997
CISPR 11 (mod)	2003	Industrial, scientific and medical (ISM) radio-frequency equipment - Electromagnetic disturbance characteristics - Limits and methods of measurement	EN 55011	2007
+ A1	2004			

Annex ZZ
(informative)

Coverage of Essential Requirements of EC Directives

This European Standard has been prepared under a mandate given to CENELEC by the European Commission and the European Free Trade Association and within its scope this standard covers all relevant essential requirements as given in Article 1 of Annex I of the EC Directive 89/108/EC.

Compliance with this standard provides one means of conformity with the specified essential requirements of the Directive concerned.

WARNING: Other requirements and other EC Directives may be applicable to the products falling within the scope of this standard.

<http://www.china-gauges.com/>

BSI — British Standards Institution

BSI is the independent national body responsible for preparing British Standards. It presents the UK view on standards in Europe and at the international level. It is incorporated by Royal Charter.

Revisions

British Standards are updated by amendment or revision. Users of British Standards should make sure that they possess the latest amendments or editions.

It is the constant aim of BSI to improve the quality of our products and services. We would be grateful if anyone finding an inaccuracy or ambiguity while using this British Standard would inform the Secretary of the technical committee responsible, the identity of which can be found on the inside front cover.
Tel: +44 (0)20 8996 9000. Fax: +44 (0)20 8996 7400.

BSI offers members an individual updating service called PLUS which ensures that subscribers automatically receive the latest editions of standards.

Buying standards

Orders for all BSI, international and foreign standards publications should be addressed to Customer Services. Tel: +44 (0)20 8996 9001.
Fax: +44 (0)20 8996 7001. Email: orders@bsi-global.com. Standards are also available from the BSI website at <http://www.bsi-global.com>.

In response to orders for international standards, it is BSI policy to supply the BSI implementation of those that have been published as British Standards, unless otherwise requested.

Information on standards

BSI provides a wide range of information on national, European and international standards through its Library and its Technical Help to Exporters Service. Various BSI electronic information services are also available which give details on all its products and services. Contact the Information Centre.
Tel: +44 (0)20 8996 7111. Fax: +44 (0)20 8996 7048. Email: info@bsi-global.com.

Subscribing members of BSI are kept up to date with standards developments and receive substantial discounts on the purchase price of standards. For details of these and other benefits contact Membership Administration.
Tel: +44 (0)20 8996 7002. Fax: +44 (0)20 8996 7001.
Email: membership@bsi-global.com.

Information regarding online access to British Standards via British Standards Online can be found at <http://www.bsi-global.com/bsonline>.

Further information about BSI is available on the BSI website at <http://www.bsi-global.com>.

Copyright

Copyright subsists in all BSI publications. BSI also holds the copyright, in the UK, of the publications of the international standardization bodies. Except as permitted under the Copyright, Designs and Patents Act 1988 no extract may be reproduced, stored in a retrieval system or transmitted in any form or by any means – electronic, photocopying, recording or otherwise – without prior written permission from BSI.

This does not preclude the free use, in the course of implementing the standard, of necessary details such as symbols, and size, type or grade designations. If these details are to be used for any other purpose than implementation then the prior written permission of BSI must be obtained.

Details and advice can be obtained from the Copyright & Licensing Manager.
Tel: +44 (0)20 8996 7070. Fax: +44 (0)20 8996 7553.
Email: copyright@bsi-global.com.