

# Low-voltage switchgear and controlgear —

Part 5-1: Control circuit devices  
and switching elements —  
Electromechanical control circuit  
devices

ICS 29.120.40; 29.130.20

## National foreword

This British Standard is the UK implementation of EN 60947-5-1:2004+A1:2009, incorporating corrigendum November 2004. It is identical with IEC 60947-5-1:2003, incorporating amendment 1:2009. It supersedes BS EN 60947-5-1:2004 which is withdrawn.

The start and finish of text introduced or altered by amendment is indicated in the text by tags. Tags indicating changes to IEC text carry the number of the IEC amendment. For example, text altered by IEC amendment 1 is indicated by A1 A1.

The UK participation in its preparation was entrusted by Technical Committee PEL/17, Switchgear, controlgear and HV-LV co-ordination, to Subcommittee PEL/17/2, Low voltage switchgear and controlgear.

A list of organizations represented on this subcommittee can be obtained on request to its secretary.

This publication does not purport to include all the necessary provisions of a contract. Users are responsible for its correct application.

**Compliance with a British Standard cannot confer immunity from legal obligations.**

### Amendments/corrigenda issued since publication

Amd. No.	Date	Comments
15484 Corrigendum No. 1	31 January 2005	Addition of Annex ZZ
	31 October 2009	Implementation of IEC amendment 1:2009 with CENELEC endorsement A1:2009

This British Standard was published under the authority of the Standards Policy and Strategy Committee on 28 June 2004

© BSI 2009

ISBN 978 0 580 69272 7

EUROPEAN STANDARD

**EN 60947-5-1:2004+A1**

NORME EUROPÉENNE

EUROPÄISCHE NORM

June 2009

ICS 29.120.40; 29.130.20

Supersedes EN 60947-5-1:1997 + A1:1999 + A2:2000  
Incorporates corrigendum November 2004

English version

**Low-voltage switchgear and controlgear**  
**Part 5-1: Control circuit devices and switching elements –**  
**Electromechanical control circuit devices**  
(IEC 60947-5-1:2003)

Appareillage à basse tension  
Partie 5-1: Appareils et éléments  
de commutation pour circuits  
de commande –  
Appareils électromécaniques  
pour circuits de commande  
(CEI 60947-5-1:2003)

Niederspannungsschaltgeräte  
Teil 5-1: Steuergeräte und Schaltelemente –  
Elektromechanische Steuergeräte  
(IEC 60947-5-1:2003)

This European Standard was approved by CENELEC on 2004-05-01. CENELEC members are bound to comply with the CEN/CENELEC Internal Regulations which stipulate the conditions for giving this European Standard the status of a national standard without any alteration.

Up-to-date lists and bibliographical references concerning such national standards may be obtained on application to the Central Secretariat or to any CENELEC member.

This European Standard exists in three official versions (English, French, German). A version in any other language made by translation under the responsibility of a CENELEC member into its own language and notified to the Central Secretariat has the same status as the official versions.

CENELEC members are the national electrotechnical committees of Austria, Belgium, Cyprus, Czech Republic, Denmark, Estonia, Finland, France, Germany, Greece, Hungary, Iceland, Ireland, Italy, Latvia, Lithuania, Luxembourg, Malta, Netherlands, Norway, Poland, Portugal, Slovakia, Slovenia, Spain, Sweden, Switzerland and United Kingdom.

**CENELEC**

European Committee for Electrotechnical Standardization  
Comité Européen de Normalisation Electrotechnique  
Europäisches Komitee für Elektrotechnische Normung

**Central Secretariat: rue de Stassart 35, B - 1050 Brussels**

## Foreword

The text of document 17B/1297/FDIS, future edition 3 of IEC 60947-5-1, prepared by SC 17B, Low voltage switchgear and controlgear, of IEC TC 17, Switchgear and controlgear, was submitted to the IEC-CENELEC parallel vote and was approved by CENELEC as EN 60947-5-1 on 2004-05-01.

This European Standard supersedes EN 60947-5-1:1997 + A1:1999 + A12:1999 + A13:2000.

This European Standard should be used in conjunction with EN 60947-1:1999.

The following dates were fixed:

- latest date by which the EN has to be implemented at national level by publication of an identical national standard or by endorsement (dop) 2005-02-01
- latest date by which the national standards conflicting with the EN have to be withdrawn (dow) 2007-02-01

This European Standard has been prepared under a mandate given to CENELEC by the European Commission and the European Free Trade Association and covers essential requirements of EC Directive(s). See Annex ZZ.

Annexes ZA and ZZ have been added by CENELEC.

The contents of the corrigendum of November 2004 have been included in this copy.

---

## Endorsement notice

The text of the International Standard IEC 60947-5-1:2003 was approved by CENELEC as a European Standard without any modification.

---

## Foreword to amendment A1

The text of document 17B/1653/FDIS, future amendment 1 to IEC 60947-5-1:2003, prepared by SC 17B, Low-voltage switchgear and controlgear, of IEC TC 17, Switchgear and controlgear, was submitted to the IEC-CENELEC parallel vote and was approved by CENELEC as amendment A1 to EN 60947-5-1:2004 on 2009-05-01.

The following dates were fixed:

- latest date by which the amendment has to be implemented at national level by publication of an identical national standard or by endorsement (dop) 2010-02-01
- latest date by which the national standards conflicting with the amendment have to be withdrawn (dow) 2012-05-01

Annex ZA has been added by CENELEC.

---

## Endorsement notice

The text of amendment 1:2009 to the International Standard IEC 60947-5-1:2003 was approved by CENELEC as an amendment to the European Standard without any modification.

---

## CONTENTS

1	General.....	6
	1.1 Scope and object .....	6
	1.2 Normative references .....	7
2	Definitions.....	9
	2.1 Basic definitions.....	11
	2.2 Control switches .....	11
	2.3 Parts of control switches.....	14
	2.4 Operation of control switches .....	16
3	Classification .....	19
	3.1 Contact elements .....	19
	3.2 Control switches .....	19
	3.3 Control circuit devices.....	19
	3.4 Time delay switching elements.....	19
	3.5 Control switch mounting.....	20
4	Characteristics .....	20
	4.1 Summary of characteristics .....	20
	4.2 Type of control circuit device or switching element.....	20
	4.3 Rated and limiting values for switching elements .....	21
	4.4 Utilization categories for switching elements .....	23
	4.5 Vacant .....	23
	4.6 Vacant .....	23
	4.7 Vacant .....	23
	4.8 Vacant .....	23
	4.9 Switching overvoltages .....	23
	4.10 Electrically separated contact elements .....	23
	4.11 Actuating quantities for pilot switches .....	23
	4.12 Pilot switches having two or more contact elements.....	24
5	Product information.....	24
	5.1 Nature of information .....	24
	5.2 Marking.....	24
	5.3 Instructions for installation, operation and maintenance .....	26
	5.4 Additional information .....	26
6	Normal service, mounting and transport conditions .....	26
7	Constructional and performance requirements .....	27
	7.1 Constructional requirements .....	27
	7.2 Performance requirements.....	29
	7.3 Electromagnetic compatibility (EMC).....	30
8	Tests.....	33
	8.1 Kinds of test.....	33
	8.2 Compliance with constructional requirements.....	34
	8.3 Performance .....	34

Annex A (normative) Electrical ratings based on utilization categories (see 3.1).....	47
Annex B (normative) Example of inductive test loads for d.c. contacts .....	49
Annex C (normative) Special tests – Durability tests .....	51
Annex D – Vacant.....	55
Annex E (normative) Items subject to agreement between manufacturer and user.....	56
Annex F (normative) Class II control circuit devices insulated by encapsulation Requirements and tests .....	57
Annex G (normative) Additional requirements for control circuit devices with integrally connected cables .....	61
Annex H (normative) Additional requirements for semiconductor switching elements for control circuit devices .....	64
Annex J (normative) Special requirements for indicator lights and indicating towers.....	73
Annex K (normative) Special requirements for control switches with direct opening action.....	79
Annex L (normative) Special requirements for mechanically linked contact elements .....	85
Annex M (normative) – Terminal marking, distinctive number and distinctive letter for control circuit devices .....	88
Figure 1 – Examples of the recommended method for drawing an operating diagram of a rotary switch.....	40
Figure 2 – Operation of push-buttons .....	41
Figure 3 – Difference $e$ between the over-travel of the actuator and that of the contact element.....	42
Figure 4 – Examples of contact elements (schematic sketches) .....	43
Figure 5 – Test circuits for multi-pole control switches – Contacts of same polarity, not electrically separated .....	44
Figure 6 – Test circuits for multi-pole control switches – Contacts of opposite polarity, and electrically separated .....	44
Figure 7 – Load $L_d$ details for test conditions requiring different values of make and break current and/or power factor (time constant) .....	45
Figure 8 – Test circuit, conditional short-circuit current (see 8.3.4.2).....	46
Figure 9 – Current/time limits for d.c. test loads (see 8.3.3.5.3).....	46
Figure B.1 – Construction of load for d.c. contacts .....	50
Figure C.1 – Normal circuit (see C.3.2.1) .....	54
Figure C.2 – Simplified circuit (see C.3.2.1) .....	54
Figure F.1 – Insulation by encapsulation .....	58
Figure F.2 – Test apparatus .....	59
Figure H.1 – Relationship between $U_e$ and $U_B$ .....	65
Figure H.2 – Example of test circuit for the verification of voltage drop, minimum operational current and OFF-state current (see H.8.2, H.8.3 and H.8.4) .....	67
Figure H.3 – Short-circuit testing (see H.8.6.1).....	68
Figure K.1 – Verification of robustness of the actuating system .....	84

Figure L.1 – Example of representation of NO and NC contacts which are mechanically linked and NC non-linked contact .....	86
Figure L.2 – Symbol for device containing mechanically linked contacts.....	86
Table 1 – Utilization categories for switching elements.....	23
Table 2 – Mounting hole diameter and dimensions of the key recess (if any).....	26
Table 3 – Preferred minimum distances between centres of mounting holes .....	27
Table 4 – Verification of making and breaking capacities of switching elements under normal conditions corresponding to the utilization categories .....	31
Table 5 – Verification of making and breaking capacities of switching elements under abnormal conditions corresponding to the utilization categories .....	32
Table A.1 – Examples of contact rating designation based on utilization categories .....	47
Table A.2 – Examples of semiconductor switching element ratings for 50 Hz and/or 60 Hz .....	48
Table A.3 – Examples of semiconductor switching element ratings for d.c. ....	48
Table B.1 – DC loads .....	50
Table C.1 – Making and breaking conditions for electrical durability .....	53
Table H.1 – Immunity tests.....	70
Table M.1 – Diagrams of control switches .....	90
Table M.2 – Diagrams of contactor relays designated by the distinctive letter E .....	92
Table M.3 – Diagrams of contactor relays designated by the distinctive letter Y.....	93

## LOW-VOLTAGE SWITCHGEAR AND CONTROLGEAR –

### Part 5-1: Control circuit devices and switching elements – Electromechanical control circuit devices

#### 1 General

The provisions of the general rules, IEC 60947-1, are applicable to this standard, where specifically called for. General rules, clauses and subclauses thus applicable, as well as tables, figures and annexes are identified by a reference to IEC 60947-1, for example 1.2.3, Table 4 or Annex A of IEC 60947-1.

##### 1.1 Scope and object

This part of IEC 60947 applies to control circuit devices and switching elements intended for controlling, signalling, interlocking, etc., of switchgear and controlgear.

It applies to control circuit devices having a rated voltage not exceeding 1 000 V a.c. (at a frequency not exceeding 1 000 Hz) or 600 V d.c.

However, for operational voltages below 100 V a.c. or d.c., see note 2 of 4.3.1.1.

This standard applies to specific types of control circuit devices such as:

- manual control switches, for example pushbuttons, rotary switches, foot switches, etc.;
- electromagnetically operated control switches, either time-delayed or instantaneous, for example contactor relays;
- pilot switches, for example pressure switches, temperature sensitive switches (thermostats), programmers, etc.;
- position switches, for example control switches operated by part of a machine or mechanism;
- associated control circuit equipment, for example indicator lights, etc.

NOTE 1 A control circuit device includes (a) control switch(es) and associated devices such as (an) indicator light(s).

NOTE 2 A control switch includes (a) switching element(s) and an actuating system.

NOTE 3 A switching element may be a contact element or a semiconductor element.

It also applies to specific types of switching elements associated with other devices (whose main circuits are covered by other standards) such as:

- auxiliary contacts of a switching device (e.g. contactor, circuit breaker, etc.) which are not dedicated exclusively for use with the coil of that device;
- interlocking contacts of enclosure doors;
- control circuit contacts of rotary switches;
- control circuit contacts of overload relays.



Contactors shall also meet the requirements and tests of IEC 60947-4-1 except for the utilization category which shall comply with this standard.

**A1** This standard does not include the relays covered in IEC 60255 or in the IEC 61810 series, nor automatic electrical control devices for household and similar purposes. **A1**

The colour requirements of indicator lights, pushbuttons, etc., are found in IEC 60073 and also in publication 2 of the International Commission of Illumination (CIE).

The object of this standard is to state:

- a) The characteristics of control circuit devices.
- b) The electrical and mechanical requirements with respect to:
  - 1) The various duties to be performed.
  - 2) The significance of the rated characteristics and of the markings.
  - 3) The tests to verify the rated characteristics.
- c) The functional requirements to be satisfied by the control circuit devices with respect to:
  - 1) Environmental conditions, including those of enclosed equipment.
  - 2) Dielectric properties.
  - 3) Terminals.

## 1.2 Normative references

The following referenced documents are indispensable for the application of this document. For dated references, only the edition cited applies. For undated references, the latest edition of the referenced document (including any amendments) applies.

IEC 60050(441):1984, *International Electrotechnical Vocabulary (IEV) – Chapter 441: Switchgear, controlgear and fuses*  
Amendment 1 (2000)

IEC 60050(446):1983, *International Electrotechnical Vocabulary (IEV) – Chapter 446: Electrical relays*

IEC 60068-2-6:1995, *Environmental testing – Part 2: Tests – Test Fc: Vibration (sinusoidal)*

IEC 60068-2-14:1984, *Environmental testing – Part 2: Tests – Test N: Change of temperature*  
Amendment 1 (1986)

IEC 60068-2-27:1987, *Environmental testing – Part 2: Tests – Test Ea and guidance: Shock*

**A1** IEC 60068-2-30:2005, *Environmental testing – Part 2-30: Tests – Test Db: Damp heat, cyclic (12 h + 12 h cycle)* **A1**

IEC 60073:2002, *Basic and safety principles for man-machine interface, marking and identification – Coding principles for indications and actuators*

IEC 60112:2003, *Method for the determination of the proof and the comparative tracking indices of solid insulating materials*

IEC 60255 (all parts), *Electrical relays*

Ⓐ IEC 60417, *Graphical symbols for use on equipment* Ⓐ

IEC 60617 (all parts), *Graphical symbols for diagrams*

Ⓐ IEC 60947-1:2007, *Low-voltage switchgear and controlgear – Part 1: General rules* Ⓐ

IEC 60947-4-1:2000, *Low-voltage switchgear and controlgear – Part 4-1: Contactors and motor-starters – Electromechanical contactors and motor-starters*

Ⓐ Amendment 1 (2002)

Amendment 2 (2005)

IEC 60947-5-5:2005, *Low-voltage switchgear and controlgear – Part 5-5: Control circuit devices and switching elements – Electrical emergency stop device with mechanical latching function* Ⓐ

IEC 61000-4-2:1995, *Electromagnetic compatibility (EMC) – Part 4-2: Testing and measurement techniques – Electrostatic discharge immunity test*

Amendment 1 (1998)

Amendment 2 (2000)

Ⓐ IEC 61000-4-3:2008, *Electromagnetic compatibility (EMC) – Part 4-3: Testing and measurement techniques – Radiated, radio-frequency, electromagnetic field immunity test*

IEC 61000-4-4:2004, *Electromagnetic compatibility (EMC) – Part 4-4: Testing and measurement techniques – Electrical fast transient/burst immunity test*

IEC 61000-4-5:2005, *Electromagnetic compatibility (EMC) – Part 4-5: Testing and measurement techniques – Surge immunity test*

IEC 61000-4-6:2008, *Electromagnetic compatibility (EMC) – Part 4-6: Testing and measurement techniques – Immunity to conducted disturbances, induced by radio-frequency fields* Ⓐ

IEC 61000-4-8:1993, *Electromagnetic compatibility (EMC) – Part 4-8: Testing and measurement techniques – Power frequency magnetic field immunity test*

Amendment 1 (2000)

Ⓐ IEC 61000-4-11:2004, *Electromagnetic compatibility (EMC) – Part 4-11: Testing and measurement techniques – Voltage dips, short interruptions and voltage variations immunity tests* Ⓐ

IEC 61000-4-13:2002, *Electromagnetic compatibility (EMC) – Part 4-13: Testing and measurement techniques – Harmonics and interharmonics including mains signalling at a.c. power port, low-frequency immunity tests*

IEC 61140:2001, *Protection against electric shock – Common aspects for installation and equipment*

Ⓐ Amendment 1 (2004)

CISPR 11:2003, *Industrial, scientific and medical (ISM) radio-frequency equipment – Electromagnetic disturbance characteristics – Limits and methods of measurement*

Amendment 1 (2004)

Amendment 2 (2006) Ⓐ

<http://www.china-gauges.com/>

## 2 Definitions

For the purposes of this part of IEC 60947 the definitions of IEC 60947-1 and the following additions apply:

<i>Alphabetical index of definitions</i> .....	References
A	
Actuating quantity .....	2.4.2.1
Adjustable delay (of a contact element) .....	2.4.1.4
B	
Biased position .....	2.4.3.4
Bounce time .....	2.4.4.10
Break-contact element (normally closed) .....	2.3.3.4
Button .....	2.3.4
C	
Change-over contact elements .....	2.3.3.5
Contact element (of a control switch) .....	2.3.3
Contact unit .....	2.3.3.10
Control circuit device .....	2.1.1
Control station .....	2.1.4
Control switch .....	2.1.2
Control switch suitable for isolation .....	2.1.3
Covered push-button .....	2.2.2.11
D	
<i>d</i> -delay (of a contact element) .....	2.4.1.2
Definite position (abbreviation: position) (of a rotary switch) .....	2.4.3.1
Delayed action push-button .....	2.2.2.9
Dependent action contact element .....	2.3.3.9
Differential value .....	2.4.2.4
Direct drive .....	2.4.4.3
Double gap contact element .....	2.3.3.2
E	
<i>e</i> -delay (of a contact element) .....	2.4.1.1
Electrically separated contact elements .....	2.3.3.7
End stop .....	2.3.6
Extended button .....	2.3.4.3
F	
Fixed delay (of a contact element) .....	2.4.1.3
Flush-button .....	2.3.4.1
Foot-switch (pedal) .....	2.2.2.21
Free push-button .....	2.2.2.13
G	
Guided push-button .....	2.2.2.14
I	
Illuminated push-button .....	2.2.2.10
Independent (snap) action contact element .....	2.3.3.8
Instantaneous contactor relay .....	2.2.1.1

	J	
Joy stick .....		2.2.2.19
	K	
Key-operated push-button .....		2.2.2.17
Key-operated rotary switch.....		2.2.2.16
	L	
Latched position .....		2.4.3.5
Latched push-button .....		2.2.2.5
Limited drive .....		2.4.4.5
Limited movement rotary switch .....		2.2.2.17
Locating mechanism (of a rotary switch) .....		2.3.5
Locked position .....		2.4.3.6
Locked push-button .....		2.2.2.6
	M	
Make-contact element .....		2.3.3.3
Minimum actuating force (or moment) .....		2.4.4.7
Minimum starting force (or moment) .....		2.4.4.6
Mushroom button .....		2.3.4.4
	O	
Operating diagram .....		2.4.3.7
Operating value .....		2.4.2.2
Over-travel of the actuator .....		2.4.4.2
Over-travel of the contact element .....		2.4.4.9
	P	
Pilot switches .....		2.2.1
Position of rest .....		2.4.3.2
Position switch .....		2.2.1.3
Positive drive .....		2.4.4.4
Pre-travel of the actuator .....		2.4.4.1
Pre-travel of the contact element .....		2.4.4.8
Programmer .....		2.2.1.4
Pull-button .....		2.2.2.2
Pulse (fleeting) contact element .....		2.3.3.6
Push-button .....		2.2.2.1
Push-pull button .....		2.2.2.3
	R	
Recessed button .....		2.3.4.2
Return value .....		2.4.2.3
Rotary control switch .....		2.2.2.15
Rotary button (selector switch) .....		2.2.2.4
	S	
Semiconductor element .....		2.3.2
Shrouded push-button .....		2.2.2.12
Single gap contact element .....		2.3.3.1
Switching element .....		2.3.1
	T	
Time-delay contactor relay .....		2.2.1.2
Time-delay push-button .....		2.2.2.8
Transit position .....		2.4.3.3

Unidirectional movement rotary switch .....	U	2.2.2.18
Wobble stick .....	W	2.2.2.20

## 2.1 Basic definitions

### 2.1.1

#### **control circuit device**

an electrical device intended for the controlling, signalling, interlocking, etc., of switchgear and controlgear

NOTE Control circuit devices may include associated devices dealt with in other standards, such as instruments, potentiometers, relays, in so far as associated devices are used for the purposes specified above.

### 2.1.2

#### **control switch (for control and auxiliary circuits)**

a mechanical switching device which serves the purpose of controlling the operation of switchgear or controlgear, including signalling, electrical interlocking, etc.

NOTE 1 A control switch consists of one or more contact elements with a common actuating system.

NOTE 2 This definition differs from IEC 441-14-46 since a control switch may include semiconductor elements or contact elements (see 2.3.2 and 2.3.3).

### 2.1.3

#### **control switch suitable for isolation**

a control switch which, in the open position, complies with the requirements specified for the isolating function (see 2.1.19 and 7.2.3.1 b) of IEC 60947-1)

NOTE Such control switches are intended to provide a higher degree of safety to personnel when working on the equipment controlled. For this reason, they have to be manually actuated relying on the intelligence of instructed persons to react in case they would fail to operate, e.g. in case of insufficiently opened contacts.

### 2.1.4

#### **control station**

an assembly of one or more control switches fixed on the same panel or located in the same enclosure

[IEV 441-12-08]

NOTE A control station panel or enclosure may also contain related equipment, e.g. potentiometers, signal lamps, instruments, etc.

## 2.2 Control switches

### 2.2.1

#### **automatic control switches**

NOTE Automatic control switches are operated by automatic control (see 2.4.5 of IEC 60947-1). They are also designated as *pilot switches* (see 2.2.18 of IEC 60947-1).

#### **2.2.1.1**

##### **instantaneous contactor relay**

a contactor relay operating without any intentional time delay

[IEV 441-14-36]

NOTE Unless otherwise stated, a contactor relay is an instantaneous contactor relay.

#### **2.2.1.2**

##### **time-delay contactor relay**

a contactor relay with specified time-delay characteristics

[IEV 441-14-37]

NOTE 1 The time-delay may be associated with energization (*e*-delay) or with de-energization (*d*-delay) or both.

NOTE 2 A time-delay contactor relay may also incorporate instantaneous contact elements.

#### **2.2.1.3**

##### **position switch**

A pilot switch the actuating system of which is operated by a moving part of the machine, when this part reaches a predetermined position

[IEV 441-14-49]

#### **2.2.1.4**

##### **programmer**

a control switch having a multiplicity of switching elements which, after initiation, operates in a defined sequence

### **2.2.2**

#### **manually operated control switches**

NOTE Manually operated control switches are operated by manual control (see 2.4.4 of IEC 60947-1).

##### **2.2.2.1**

###### **push-button**

a control switch having an actuator intended to be operated by force exerted by a part of the human body, usually the finger or palm of the hand, and having stored energy (spring) return

[IEV 441-14-53]

##### **2.2.2.2**

###### **pull-button**

a control switch having an actuator intended to be operated by manual pull, and having stored energy (spring) return

##### **2.2.2.3**

###### **push-pull button**

a control switch having an actuator intended to be operated by manual push and returned to its initial position by manual pull, or vice versa

NOTE There are also «push-push» or «push-turn» or other combinations of buttons.

##### **2.2.2.4**

###### **rotary button (e.g.: selector switch)**

a combination of push-button type switching elements having an actuator operated by a manual rotation (see also 2.2.2.15 to 2.2.2.18 inclusive)

NOTE A rotary push-button may have more than two positions; it may or may not have a spring return.

<http://www.china-gauges.com/>

**2.2.2.5****latched push-button**

a push-button with spring return, but which remains in the actuated position until a latch is released by a separate action

NOTE The latching may be released by subsequent actuation (such as pushing, turning, etc.) of the same or of an adjacent push-button or by the action of an electromagnet, etc.

**2.2.2.6****locked push-button**

a push-button which may be secured in one or more of its positions by a separate action

NOTE The locking may be obtained by turning the button, by turning a key, by operating a lever, etc.

**2.2.2.7****key-operated push-button**

a push-button which can only be operated as long as a key remains inserted

NOTE Key withdrawal may be provided at any position.

**2.2.2.8****time-delay push-button**

a push-button the contacts of which return to the initial position only after a pre-determined interval of time following the release of the actuating force

**2.2.2.9****delayed action push-button**

a push-button in which the switching operation does not occur until after the force on the button has been maintained for a pre-determined interval of time

**2.2.2.10****illuminated push-button**

a push-button incorporating a signalling lamp in the button

**2.2.2.11****covered push-button**

a push-button in which the button is protected against inadvertent operation by a lid or a cover

**2.2.2.12****shrouded push-button**

a push button in which the button is protected against inadvertent operation in certain directions

**2.2.2.13****free push-button**

a push-button in which the rotation of the actuator around its axis is not limited

**2.2.2.14****guided push-button**

a push-button in which the rotation of the actuator around its axis is prevented

NOTE Examples of guided push-buttons: the actuators of which are keyed, square or rectangular, etc.

**2.2.2.15****rotary control switch (abbreviation: rotary switch)**

a control switch having an actuator intended to be operated by rotation

#### 2.2.2.16

##### **key-operated rotary switch**

a rotary switch where a key is used as the actuator

NOTE Key withdrawal may be provided at any position.

#### 2.2.2.17

##### **limited movement rotary switch**

a rotary switch with a restricted angular movement of its actuator

#### 2.2.2.18

##### **unidirectional movement rotary switch**

a rotary switch in which the actuating system allows rotation in one direction only

#### 2.2.2.19

##### **joy stick**

a control switch having an actuator consisting of a pin or stick projecting essentially at a right angle from the panel or enclosure when in one of its positions and intended to be operated by angular displacement

NOTE 1 A joy stick may have more than two positions associated with different directions of the displacement of the stick and operating the contact elements differently: such a joy stick is referred to as a joy stick selector.

NOTE 2 The pin or stick may or may not have a spring return.

#### 2.2.2.20

##### **wobble stick**

a joy stick which operates all contact elements alike, whatever be the direction of the displacement

#### 2.2.2.21

##### **foot switch (pedal)**

a control switch having an actuator intended to be operated by force exerted by a foot

[IEV 441-14-52 modified]

### 2.3 Parts of control switches

#### 2.3.1

##### **switching element**

a switching element may be a semiconductor element (see 2.3.2) or a contact element (see 2.3.3)

#### 2.3.2

##### **semiconductor element**

an element designed to switch the current of an electric circuit by means of the controlled conductivity of a semiconductor

#### 2.3.3

##### **contact element (of a control switch)**

the parts, fixed and movable, conducting and insulating, of a control switch necessary to close and open one single conducting path of a circuit

NOTE 1 The contact element and the actuating system may form an indivisible unit, but frequently one or more contact elements may be combined with one or more actuating system or systems. The actuating systems may be different.

NOTE 2 Definitions relating to various kinds of contact elements are given in 2.3.3.1 to 2.3.3.10 inclusive.

NOTE 3 This definition does not include control coils and magnet systems.



The following definitions refer to a single contact element of a control switch:

#### 2.3.3.1

**single gap contact element** (see Figures 4 a) and 4 c))

a contact element which opens or closes the conducting path of its circuit on one location only

#### 2.3.3.2

**double gap contact element** (see Figures 4 b), 4 d) and 4 e))

a contact element which opens or closes the conducting path of its circuit in two locations in series

#### 2.3.3.3

**make-contact element (normally open)**

a contact element which closes a conducting path when the control switch is actuated

#### 2.3.3.4

**break-contact element (normally closed)**

a contact element which opens a conducting path when the control switch is actuated

#### 2.3.3.5

**change-over contact elements** (see Figures 4 c), 4 d) and 4 e))

a contact element combination which includes one make-contact element and one break-contact element

#### 2.3.3.6

**pulse (fleeting) contact element**

a contact element which opens or closes a circuit for a part of the travel during the transition of the actuator from one position to another

#### 2.3.3.7

**electrically separated contact elements**

contact elements belonging to the same control switch, but adequately insulated from each other so that they can be connected into electrically separated circuits

[IEV 441-15-24]

#### 2.3.3.8

**independent (snap) action contact element**

a contact element of a manual or automatic control device in which the velocity of contact motion is substantially independent of the velocity of motion of the actuator

#### 2.3.3.9

**dependent action contact element**

a contact element of a manual or automatic control device in which the velocity of contact motion depends on the velocity of motion of the actuator

#### 2.3.3.10

**contact unit**

a contact element or contact element combination which can be combined with similar units operated by a common actuating system

#### 2.3.4

##### **button**

the external end of the actuator of a push-button, to which the actuating force is applied

#### 2.3.4.1

##### **flush-button**

a button which is substantially level with the adjacent fixed surrounding surface when in its initial position and is below this surface when it is operated

#### 2.3.4.2

##### **recessed button**

a button which is below the adjacent fixed surrounding surface in both its initial and operated positions

#### 2.3.4.3

##### **extended button**

a button which protrudes above the adjacent fixed surrounding surface both in its initial position and in its operated position

#### 2.3.4.4

##### **mushroom button**

a button, the protruding end of which has an enlarged diameter

#### 2.3.5

##### **locating mechanism (of a rotary switch)**

that part of the actuating system which retains the actuator and/or the contact elements in their positions

#### 2.3.6

##### **end stop**

a device that limits the travel of a moving part

NOTE An end stop may relate either to the actuator or to the contact element.

## 2.4 Operation of control switches

### 2.4.1 Operation of contactor relays

#### 2.4.1.1

##### **e-delay (of a contact element)**

a delay in the operation of a contact element of a contactor relay, following the energization of the coil of the electromagnet of this contactor relay

Example: delay to close make-contacts (ON delay).

#### 2.4.1.2

##### **d-delay (of a contact element)**

a delay in the operation of a contact element of a contactor relay, following the de-energization of the coil of the electromagnet of this contactor relay

Example: delay to open make-contacts (OFF delay)

Note for 2.4.1.1 and 2.4.1.2 – The terms 'e-delay' and 'd-delay' may be applied to any kind of contact elements (see 2.3.3).

#### 2.4.1.3

##### **fixed delay (of a contact element)**

a delay in the operation of a contact element of a contactor relay, which is not intended to be adjusted in value

#### 2.4.1.4

##### **adjustable delay (of a contact element)**

a delay in the operation of a contact element of a contactor relay which is intended to be adjusted to different values after the installation of the contactor relay

#### 2.4.2 Operation of pilot switches

##### 2.4.2.1

##### **actuating quantity**

the physical quantity, the value of which is decisive for the actuation or non-actuation of a pilot switch

##### 2.4.2.2

##### **operating value**

the value of the actuating quantity which is sufficient to cause a pilot switch to be actuated

##### 2.4.2.3

##### **return value**

the value of the actuating quantity which has to be re-established in order to cause an actuated pilot switch to return to its position of rest

##### 2.4.2.4

##### **differential value**

the difference between the operating value and the return value

#### 2.4.3 Operation of rotary switches

##### 2.4.3.1

##### **definite position (abbreviation: position) (of a rotary switch)**

a position into which the locating mechanism pulls the rotary switch and retains it as long as the actuating moment does not exceed a certain value

##### 2.4.3.2

##### **position of rest**

a stable (definite) position into which the locating mechanism tends to move back and retain the rotary switch by stored energy

##### 2.4.3.3

##### **transit position**

a (definite) position in which the locating mechanism produces an intended marked change in the operating moment, but in which the actuator cannot remain by itself

##### 2.4.3.4

##### **biased position**

a (definite) position of a rotary switch in which the actuator is pulled against a stop from which it will return to a position of rest by means of stored energy (for example, by means of a spring)

NOTE During the transfer from a biased position to the adjacent position of rest, the rotary switch may pass through one or more transit positions.

#### 2.4.3.5

##### **latched position**

a biased position in which the return mechanism is held by a latching arrangement

NOTE The latching arrangement may be released manually or otherwise.

#### 2.4.3.6

##### **locked position**

a (definite) position in which a rotary switch is secured by separate means

NOTE The locking may be obtained by turning a key, operating a lever, etc.

#### 2.4.3.7

##### **operating diagram**

the representation of the intended operation in which the contact elements of a rotary switch operate as a result of actuation

### 2.4.4 Operation of mechanically operated control switches

#### 2.4.4.1

##### **pre-travel of the actuator** (dimension *a* on Figure 2)

the maximum travel of the actuator which causes no travel of the contact elements

#### 2.4.4.2

##### **over-travel of the actuator**

the travel of the actuator after all the contacts have reached their closed (open) position

#### 2.4.4.3

##### **direct drive**

a connection between actuator and contact element that excludes any pre-travel of the actuator

#### 2.4.4.4

##### **positive drive**

a connection between actuator and contact element such that the force applied to the actuator is directly transmitted to the contact element

#### 2.4.4.5

##### **limited drive**

a connection between actuator and contact element that limits the force transmitted to the contact element

#### 2.4.4.6

##### **minimum starting force (or moment)**

the smallest value of force (or moment) initiating the pre-travel of the actuator

#### 2.4.4.7

##### **minimum actuating force (or moment)**

the minimum value of the force (or moment) to be applied to the actuator that will cause all contacts to reach their closed (open) position

#### 2.4.4.8

##### **pre-travel of the contact element** (dimension *b* on Figure 2)

the relative movement which occurs within the contact element before the contacts make (break)

#### 2.4.4.9

**over-travel of the contact element** (dimension  $d$  on Figure 2)

the relative movement which occurs within the contact element after the contacts have reached the make (break) position

#### 2.4.4.10

**bounce time**

for a contact which is closing (opening) its circuit, the time interval between the instant when the contact circuit first closes (opens) and the instant when the circuit is finally closed (opened)

[IEV 446-17-13]

### 3 Classification

#### 3.1 Contact elements

Contact elements may be classified as follows:

- a) Utilization categories (see 4.4).
- b) Electrical ratings based on utilization categories (see Annex A).
- c) One of the following form letters (see Figure 4):
  - 1) Form A – Single gap make-contact element;
  - 2) Form B – Single gap break-contact element;
  - 3) Form C – Single gap make-break three terminal change-over contact element;
  - 4) Form X – Double gap make-contact element;
  - 5) Form Y – Double gap break-contact element;
  - 6) Form Z – Double gap make-break four terminal change-over contact element.
- d) Other types not included in c).

NOTE 1 Regarding Figure 4e). the two moving contact elements are electrically separated (see 2.3.3.7).

NOTE 2 Distinction is made between make before break (overlap) change-over contact elements where the two circuits are both closed for a part of the travel of the moving contacts from one position to the other, and break before make (non-overlap) change-over contact elements where the two circuits are both open for a part of the travel of the moving contacts from one position to the other. Unless otherwise stated, change-over contact elements are break before make.

#### 3.2 Control switches

Control switches may be classified according to the contact element and the nature of the actuating system, e.g. push-buttons, form X.

#### 3.3 Control circuit devices

Control circuit devices may be classified according to the control switch and the associated control circuit equipment, e.g. push-buttons plus indicator lights.

#### 3.4 Time delay switching elements

Distinction is made according to how the time delay of a switching element is achieved, e.g. electrical delay, magnetic delay, mechanical delay, or pneumatic delay.

### **3.5 Control switch mounting**

The control switch mounting may be classified by the mounting hole size, e.g. D12, D16, D22, D30 (see 6.3.1).

## **4 Characteristics**

### **4.1 Summary of characteristics**

The characteristics of control circuit devices and switching elements should be stated in the following terms, where such terms are applicable:

- type of equipment (see 4.2);
- rated and limiting values for switching elements (see 4.3);
- utilization categories of switching elements (see 4.4);
- normal and abnormal load characteristics (see 4.3.5);
- switching overvoltages (see 4.9).

#### **4.1.1 Operation of a control switch**

The principal application of a control switch is the switching of loads as indicated for the various utilization categories in Table 1.

Other applications, e.g. the switching of tungsten filament lamps, small motors, etc., are not dealt with in detail in this standard, but are mentioned in 4.3.5.2.

##### **4.1.1.1 Normal conditions of use**

The normal use of a control switch is to close, maintain and open circuits in accordance with the utilization category shown in Table 1. Also refer to Table 4.

##### **4.1.1.2 Abnormal conditions of use**

Abnormal conditions may arise, for example, when an electromagnet, although energized, has failed to close. Refer to Table 5.

A control switch shall be able to break the current corresponding to such conditions of use.

## **4.2 Type of control circuit device or switching element**

The following shall be stated:

### **4.2.1 Kind of control circuit device**

- manual control switches, e.g. push-buttons, rotary switches, foot switches, etc.;
- electromagnetically operated control switches, either time delayed or instantaneous, e.g. contactor relays;
- pilot switches, e.g. pressure switches, temperature sensitive switches (thermostats), programmers, etc.;
- position switches;
- associated control equipment, e.g. indicator lights, etc.

#### 4.2.2 Kind of switching elements

- auxiliary contacts of a switching device (e.g. contactor, circuit breaker, etc.) which are not dedicated exclusively for use with the coil of that device;
- interlocking contacts of enclosure doors;
- control circuit contacts of rotary switches;
- control circuit contacts of overload relays.

#### 4.2.3 Number of poles

#### 4.2.4 Kind of current

Alternating current or direct current.

#### 4.2.5 Interrupting medium

Air, oil, gas, vacuum, etc.

#### 4.2.6 Operating conditions

##### 4.2.6.1 Method of operation

Manual, electromagnetic, pneumatic, electro-pneumatic.

##### 4.2.6.2 Method of control

- automatic;
- non-automatic;
- semi-automatic.

#### 4.3 Rated and limiting values for switching elements

The rated values established for the switching elements of a control circuit device shall be stated in accordance with 4.3.1 to 4.3.5 inclusive but it is not necessary to specify all the values listed.

##### 4.3.1 Rated voltages (of a switching element)

A switching element is defined by the following rated voltages:

###### 4.3.1.1 Rated operational voltage ( $U_e$ )

Subclause 4.3.1.1 of IEC 60947-1 applies with the following additions:

For three-phase circuits,  $U_e$  is stated as r.m.s. voltage between phases.

NOTE 1 A switching elements may be assigned a number of combinations of rated operational voltage and rated operational current.

NOTE 2 Control switches dealt with in this standard are not normally intended to be used at very low voltages and they may not be suitable for such a service. It is therefore recommended to seek the advice of the manufacturer concerning any application with a low value of operational voltage, e.g. below 100 V a.c. or d.c.

###### 4.3.1.2 Rated insulation voltage ( $U_i$ )

Subclause 4.3.1.2 of IEC 60947-1 applies.

#### 4.3.1.3 Rated impulse withstand voltage ( $U_{imp}$ )

Subclause 4.3.1.3 of IEC 60947-1 applies.

#### 4.3.2 Currents

A switching element is characterized by the following currents:

##### 4.3.2.1 Conventional free air thermal current ( $I_{th}$ )

Subclause 4.3.2.1 of IEC 60947-1 applies.

##### 4.3.2.2 Conventional enclosed thermal current ( $I_{the}$ )

Subclause 4.3.2.2 of IEC 60947-1 applies.

##### 4.3.2.3 Rated operational current ( $I_e$ )

The first paragraph of 4.3.2.3 of IEC 60947-1 applies.

#### 4.3.3 Rated frequency

Subclause 4.3.3 of IEC 60947-1 applies.

#### 4.3.4 Vacant

#### 4.3.5 Normal and abnormal load characteristics

##### 4.3.5.1 Rated making and breaking capacities and behaviour of switching elements under normal conditions

A switching element shall comply with both requirements given in Table 4 corresponding to the assigned utilization category and the requirements according to the rated operational voltage.

NOTE 1 For a switching element to which a utilization category is assigned, it is not necessary to specify separately a making and breaking capacity.

NOTE 2 A switching element used for the switching of small motors and tungsten filament lamp loads shall be assigned a utilization category given in IEC 60947-4-1 and comply with the appropriate corresponding requirements in that publication.

##### 4.3.5.2 Making and breaking capacities under abnormal conditions

A switching element shall comply with the requirements given in Table 5 corresponding to the assigned utilization category.

NOTE An example of an abnormal condition of use is one where the electromagnet does not operate and the switching elements have to interrupt the making current.

#### 4.3.6 Short-circuit characteristics

##### 4.3.6.1 Rated conditional short-circuit current

Subclause 4.3.6.4 of IEC 60947-1 applies.



#### 4.4 Utilization categories for switching elements

The utilization categories as given in Table 1 are considered standard. Any other types of application shall be based on agreement between manufacturer and user, but information given in the manufacturer's catalogue or tender may constitute such an agreement.

Table 1 – Utilization categories for switching elements

Kind of current	Category	Typical applications
Alternating current	AC-12	Control of resistive loads and solid state loads with isolation by optocouplers
	AC-13	Control of solid state loads with transformer isolation
	AC-14	Control of small electromagnetic loads ( $\leq 72$ VA)
	AC-15	Control of electromagnetic loads ( $> 72$ VA)
Direct current	DC-12	Control of resistive loads and solid state loads with isolation by optocouplers
	DC-13	Control of electromagnets
	DC-14	Control of electromagnetic loads having economy resistors in circuit

#### 4.5 Vacant

#### 4.6 Vacant

#### 4.7 Vacant

#### 4.8 Vacant

#### 4.9 Switching overvoltages

Subclause 4.9 of IEC 60947-1 applies.

#### 4.10 Electrically separated contact elements

The manufacturer shall state whether the contact elements of a control circuit device are electrically separated or not (see 2.3.3.7).

#### 4.11 Actuating quantities for pilot switches

The operating value and return value of the actuating quantity are to be determined on uniform rising values and normal falling values of the actuating quantity. Unless otherwise stated, the rate of change shall be regular and such that the operating (or return) value is reached in not less than 10 s.

The operating value and the return value may both be fixed values, or one of them or both may be adjustable (or the differential value may be adjustable).

Where appropriate, the manufacturer shall indicate a withstand value, either a maximum value higher than the highest setting of the operating value or a minimum value lower than the lowest setting of the return value. A withstand value implies no damage to the pilot switch or no change in its characteristics.

#### 4.12 Pilot switches having two or more contact elements

Pilot switches having two or more contact elements which are not individually adjustable may have different operating and return values for each contact element.

A pilot switch having two or more contact elements which are individually adjustable is considered as a combination of pilot switches.

### 5 Product information

#### 5.1 Nature of information

The following information shall be given to the manufacturer:

##### *Identification*

- a) The manufacturer's name or trade mark.
- b) A type designation or serial number that makes it possible to get the relevant information concerning the switching element (or the entire control switch) from the manufacturer or from his catalogue or by selection from Annex A.
- c) IEC 60947-5-1 if the manufacturer claims compliance with this standard.

##### *Basic rated values and utilization*

- d) Rated operational voltages (see 4.3.1.1).
- e) Utilization category and rated operational currents at the rated operational voltages of the control circuit device.
- f) Rated insulation voltage (see 4.3.1.2).
- g) Rated impulse withstand voltage (see 4.3.1.3).
- h) Switching overvoltage, if applicable (see 4.9).
- i) IP code, in case of an enclosed control circuit device (see 5.1 and Annex C of IEC 60947-1).
- j) Pollution degree (see 6.1.3.2).
- k) Type and maximum ratings of short-circuit protective device (see 8.3.4.3).
- l) Conditional short-circuit current.
- m) Suitability for isolation, where applicable, with the symbol 07-13-06 of IEC 60617-7.
- n) Indication of contact elements of same polarity.

#### 5.2 Marking

##### 5.2.1 General

Marking of data under a) and b) of 5.1 is mandatory on the nameplate of the control circuit device in order to permit the complete information to be obtained from the manufacturer.

Marking shall be indelible and easily legible, and shall not be placed on screws and removable washers.

Whenever space permits, data under c) to n) shall be included on the nameplate, or on the control circuit device or otherwise in the manufacturer's published literature.

## 5.2.2 Terminal identification and marking

**A1** Subclause 7.1.8.4 of IEC 60947-1 applies. **A1**

## 5.2.3 Functional markings

Actuators may be identified by symbols in the form of engravings. If a stop button carries any symbol engraved or marked on the actuator, then this symbol shall be a circle or an oval (signifying the value zero). The symbols circle or oval shall be used for stop-buttons only.

Letters or words may be used where the space available is sufficient to ensure a clear identification. In all other cases, identification markings shall be placed on permanent labels surrounding each actuator or closely adjacent to it.

**A1** Symbols shall be in accordance with IEC 60417. **A1**

## 5.2.4 Emergency stop

**A1** Actuator shape and colour, background colour and direction of unlatching for emergency stop devices with mechanical latching function shall be in accordance with 4.2 of IEC 60947-5-5. **A1**

## 5.2.5 Operating diagram

As rotary switches may have a multiplicity of contact elements and a multiplicity of actuator positions, it is necessary that the manufacturer indicates the relationship between the actuator positions and the associated contact element positions.

It is recommended that the relationship be given in the form of an operating diagram, examples of which are shown in Figure 1 together with explanatory notes.

### 5.2.5.1 Position indication

The position indication shall be clear, and the associated text or symbols shall be indelible and easily legible.

### 5.2.5.2 Terminal markings for operating diagrams

Terminal markings shall be clearly identifiable with respect to the operating diagram.

**A1** See also Annex M. **A1**

## 5.2.6 Time delay markings

For time-delay contactor relays, the markings shall include the value of the time delay in the case of a fixed delay and the range of time delay in the case of an adjustable delay.

In the case of more than one time-delay contact element, the relative delay between the operation of each contact element and the following one may be indicated for contact elements that follow the first delay.

If two or more contact elements have adjustable delays, it shall be indicated whether they are individually adjustable or not.

The manufacturer shall indicate, for each time-delay contact element, the characteristics of the delay, according to 2.4.1.1 or 2.4.1.2.

### 5.3 Instructions for installation, operation and maintenance

Subclause 5.3 of IEC 60947-1 applies.

### 5.4 Additional information

Additional information necessary for certain types of control circuit devices shall appear according to the relevant rules of the appropriate Annexes J and K.

Such additional information shall be supplied by the manufacturer and may be in the form of a wiring diagram or in the instruction sheet supplied with the control circuit device.

## 6 Normal service, mounting and transport conditions

Clause 6 of IEC 60947-1 applies with the following additions:

### 6.1.3.2 Pollution degree

Unless otherwise stated by the manufacturer, a control circuit device is intended for installation under environmental conditions of pollution degree 3. However, other pollution degrees may apply, depending upon the micro-environment.

### 6.3.1 Mounting of single hole mounted devices

The single hole mounted push-buttons and indicator lights are located in a circular hole of the panel, which may have a rectangular recess for a key.

The dimensions are indicated in Table 2:

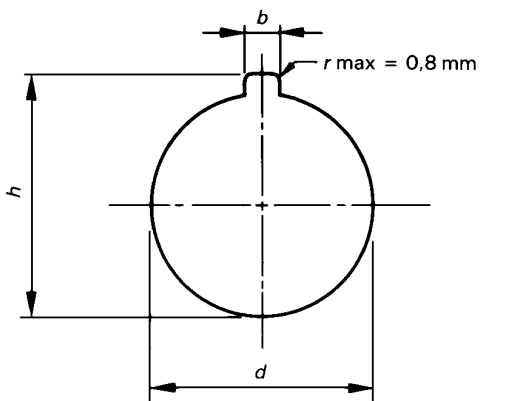

**Table 2 – Mounting hole diameter and dimensions of the key recess (if any)**

Size	Mounting hole diameter, $d$ mm	Key recess (if any)	
		Height, $h$ mm	Width, $b$ mm
D30	30,5 $\begin{smallmatrix} +0,5 \\ 0 \end{smallmatrix}$	33,0 $\begin{smallmatrix} +0,5 \\ 0 \end{smallmatrix}$	4,8 $\begin{smallmatrix} +0,2 \\ 0 \end{smallmatrix}$
D22	22,3 $\begin{smallmatrix} +0,4 \\ 0 \end{smallmatrix}$	24,1 $\begin{smallmatrix} +0,4 \\ 0 \end{smallmatrix}$	3,2 $\begin{smallmatrix} +0,2 \\ 0 \end{smallmatrix}$
D16	16,2 $\begin{smallmatrix} +0,2 \\ 0 \end{smallmatrix}$	17,9 $\begin{smallmatrix} +0,2 \\ 0 \end{smallmatrix}$	1,7 $\begin{smallmatrix} +0,2 \\ 0 \end{smallmatrix}$
D12	12,1 $\begin{smallmatrix} +0,2 \\ 0 \end{smallmatrix}$	13,8 $\begin{smallmatrix} +0,2 \\ 0 \end{smallmatrix}$	1,7 $\begin{smallmatrix} +0,2 \\ 0 \end{smallmatrix}$

#### 6.3.1.1 Location of the key recess (if any)

The standardized position of the key is in the up position (12 o'clock) and associated with the  $b$  dimension in Table 3.

### 6.3.1.2 Range of panel thickness

The device, with or without the sealing gasket indicated by the manufacturer, shall be capable of being mounted on any thickness of panel between 1 mm and 6 mm, if necessary by the use of packing piece(s) supplied for the purpose.

NOTE The sealing gasket is not standardized.

### 6.3.1.3 Grouping of devices

When a number of devices of the sizes given in 6.3.1 are mounted in rows on a panel, the distances  $a$  between the mounting centres in the same row and  $b$  between the centre lines of the rows shall be not less than those given in Table 3, unless otherwise stated by the manufacturer.

Table 3 – Preferred minimum distances  
between centres of mounting holes

Size	$a$ mm	$b$ mm
D30	50	65
D22	30	50
D16	25	25
D12	20	20

Distances  $a$  and  $b$  may be interchanged.

These values are intended to guide development; however, when it is intended to mount devices of different manufacture, the user shall establish the compatibility of the devices and ensure the clearances and creepage distances are maintained when the devices are installed and connected.

NOTE Depending on design details, connections, labels, etc., some devices may be capable of being mounted at distances less than those given in Table 3 in accordance with the indication of the manufacturer of the devices. On the other hand, certain types of devices may require distances greater than those given in Table 3.

## 7 Constructional and performance requirements

### 7.1 Constructional requirements

**A1** Subclause 7.1 of IEC 60947-1 applies except for 7.1.2, 7.1.3, 7.1.7, 7.1.9 and 7.1.13, and with the following additions: **A1**

#### 7.1.1 Materials

Materials shall be suitable for the particular application and shall enable the equipment to comply with the relevant test requirements.

Special attention shall be called to flame and humidity resisting qualities, and to the necessity to protect certain insulating materials against humidity.

NOTE Requirements are under consideration.

### 7.1.2 Current-carrying parts and their connections

Current-carrying parts shall have the necessary mechanical strength and current-carrying capacity for their intended use.

For electrical connections, no contact pressure shall be transmitted through insulating material other than ceramic or other material with characteristics not less suitable, unless there is sufficient resiliency in the metallic parts to compensate for any possible shrinkage or yielding of the insulation material.

### 7.1.3 Clearances and creepage distances

<sup>A1</sup> Minimum values are given in Table 13 and Table 15 of IEC 60947-1. <sup>A1</sup>

#### 7.1.4.3 Actuating force (or moment)

The force (or moment) required to operate the actuator shall be compatible with the intended application, taking into account the size of the actuator, the type of enclosure or panel, the environment of the installation and the use for which it is intended.

The minimum starting force (or moment) shall be sufficiently large to prevent inadvertent operation; e.g. push-buttons and rotary switches to be used with enclosures complying with degrees of protection IPX5 or IPX6 shall not become actuated when hit by the jet of water applied during the test of the enclosed equipment.

#### 7.1.4.4 Limitation of rotation (of a rotary switch)

When actuators with limited or unidirectional movement are used, they shall be fitted with robust means of limitation, capable of withstanding five times the actual maximum actuating moment.

#### 7.1.4.5 Emergency stop

The actuator shall preferably latch in the actuated position with the control contact open. This latching shall be released by a separate action, e.g. by pulling, rotation, or by means of a key.

<sup>A1</sup> NOTE Additional requirements for emergency stop devices with a latching function are given in IEC 60947-5-5. <sup>A1</sup>

### 7.1.6 Conditions for control switches suitable for isolation

<sup>A1</sup> A control switch suitable for isolation shall be manually operated with a direct opening action (see Annex K) and shall comply with the isolating function in the open position (see 2.1.19 and 7.1.7 of IEC 60947-1). <sup>A1</sup>

The open position of a control switch suitable for isolation shall be a position in which the switch can remain when no actuating force is applied.

In order to avoid unintentional reclosing, it shall be possible to prevent the operation of the control switches suitable for isolation when the contact elements are in the open position. This may be obtained by padlocking or by a latch which shall only be releasable by a special tool or key.

#### **7.1.7 Class II control circuit devices**

These devices shall not be provided with means for protective earthing (see IEC 61140).

For class II control circuit devices insulated by encapsulation, see Annex F.

#### **7.1.8 Requirements for control devices with integrally connected cables**

See Annex G.

### **7.2 Performance requirements**

Subclauses 7.2.1.1 and 7.2.2 of IEC 60947-1 apply with the following additions:

#### **7.2.1.2 Limits of operation of contactor relays**

The limits of operation for contactor relays shall be in accordance with IEC 60947-4-1.

#### **7.2.3 Dielectric properties**

Subclause 7.2.3 of IEC 60947-1 applies with the following addition.

For Class II control circuit devices insulated by encapsulation, see Annex F.

#### **7.2.4 Ability to make and break under normal and abnormal load conditions**

##### **7.2.4.1 Making and breaking capacities**

###### *a) Making and breaking capacities under normal conditions*

The switching elements shall be capable of making and breaking currents without failure under the conditions stated in Table 4, for the required utilization categories and the number of operating cycles indicated, under the conditions specified in 8.3.3.5.2.

During this test the overvoltages generated shall not exceed the impulse withstand voltage values stated by the manufacturer (see 7.2.6).

###### *b) Making and breaking capacities under abnormal conditions*

The switching elements shall be capable of making and breaking currents without failure under the conditions stated in Table 5, for the required utilization categories and the number of operating cycles specified in Table 5.

##### **7.2.4.2 Vacant**

### **7.2.4.3 Durability**

Subclause 7.2.4.3 of IEC 60947-1 applies with the following additions:

a) *Mechanical durability*

The mechanical durability of a control circuit device is verified, when needed, by a special test conducted at the discretion of the manufacturer. Instructions for conducting this test are given in Annex C.

b) *Electrical durability*

The electrical durability of a control circuit device is verified, when needed, by a special test conducted at the discretion of the manufacturer. Instructions for conducting this test are given in Annex C.

### **7.2.5 Conditional short-circuit current**

The switching element shall withstand the stresses resulting from short-circuit currents under the conditions specified in 8.3.4.

### **7.2.6 Switching overvoltage**

Subclause 7.2.6 of IEC 60947-1 applies.

### **7.2.7 Additional requirements for control switches suitable for isolation**

Control switches suitable for isolation shall be tested according to 8.3.3.4 of IEC 60947-1 with a value of test voltage as specified in Table 14 of IEC 60947-1 corresponding to the rated impulse withstand voltage  $U_{imp}$  declared by the manufacturer.

Other additional requirements applicable to such control switches are under consideration.

### **7.3 Electromagnetic compatibility (EMC)**

Subclause 7.3 of IEC 60947-1 applies unless otherwise specified in this standard.



**Table 4 – Verification of making and breaking capacities of switching elements under normal conditions corresponding to the utilization categories<sup>1)</sup>**

Table 4a							Table 4b			
Utilization category	Make <sup>2)</sup>			Break <sup>2)</sup>			Minimum on-time	Sequence number and rate of operations		
	$I/I_e$	$U/U_e$		$I/I_e$	$U/U_e$			Order <sup>7)</sup>	Number	Rate per minute
<b>AC</b>			$\cos \phi$			$\cos \phi$	<b>Cycles</b> (at 50 Hz or 60 Hz)			
AC-12	1	1	0,9	1	1	0,9	2	1	50 <sup>4)</sup>	6
AC-13	2	1	0,65	1	1	0,65	2 <sup>3)</sup>	2	10	Rapidly <sup>5)</sup>
AC-14	6	1	0,3	1	1	0,3	2 <sup>3)</sup>	3	990	60
AC-15	10	1	0,3	1	1	0,3	2 <sup>3)</sup>	4	5 000	6
<b>DC</b>			$T_{0,95}$ ms			$T_{0,95}$ ms	<b>Time</b> ms			
DC-12	1	1	1	1	1	1	25			
DC-13	1	1	$6 \cdot P^6)$	1	1	$6 \cdot P^6)$	$T_{0,95}$			
DC-14	10	1	15	1	1	15	25 <sup>3)</sup>			

$I_e$  Rated operational current

$U_e$  Rated operational voltage

$P = U_e \cdot I_e$  Steady-state power consumption, in W

$I$  Current to be made or broken

$U$  Voltage before make

$T_{0,95}$  Time to reach 95 % of the steady-state current

1) See 8.3.3.5.2.

2) For tolerances on test quantities, see 8.3.2.2.

3) Both on-time values (for  $I_{make}$  and for  $I_{break}$ ) shall be at least equal to 2 cycles (or 25 ms for DC-14).

4) The first 50 operating cycles shall be made with the test voltage raised to  $U_e \cdot 1,1$ , the test current  $I_e$  having been first set with the voltage at  $U_e$ .

5) As rapidly as possible whilst ensuring complete closing and opening of contacts.

6) The value " $6 \cdot P$ " results from an empirical relationship which is found to represent most d.c. magnetic loads to an upper limit of  $P = 50$  W, i.e.  $6 \cdot P = 300$  ms. Loads having power consumption greater than 50 W are assumed to consist of smaller loads in parallel. Therefore, 300 ms is to be an upper value, irrespective of the power.

7) For all utilization categories the test sequence shall be in the order given.

**Table 5 – Verification of making and breaking capacities of switching elements under abnormal conditions corresponding to the utilization categories<sup>1)</sup>**

Utilization category	Make <sup>2)</sup>			Break <sup>2)</sup>			Minimum on-time	Making and breaking operation	
	$I/I_e$	$U/U_e$		$I/I_e$	$U/U_e$			Number	Rate per minute
<b>AC</b>			cos .			cos .	Cycles at 50 Hz (or 60 Hz)		
AC-12	–	–	–	–	–	–	–	–	–
AC-13 <sup>3)</sup>	10	1,1	0,65	1,1	1,1	0,65	2 <sup>4)</sup>	10	6
AC-14	6	1,1	0,7	1,1	1,1	0,7	2	10	6
AC-15	10	1,1	0,3	1,1	1,1	0,3	2	10	6
<b>DC</b>			$T_{0,95}$ ms			$T_{0,95}$ ms	<b>Time</b> ms		
DC-12									
DC-13 <sup>3)</sup>	1,1	1,1	$6 \cdot P^5)$	1,1	1,1	$6 \cdot P^5)$	$T_{0,95}$	10	6
DC-14	10	1,1	15	10	1,1	15	25 <sup>4)</sup>	10	6
$I_e$ Rated operational current			$I$ Current to be made or broken						
$U_e$ Rated operational voltage			$U$ Voltage before make						
$P = U_e \cdot I_e$ Steady-state power consumption, in W			$T_{0,95}$ Time to reach 95 % of the steady-state current						
<p>1) The abnormal condition is to simulate a blocked open electromagnet. See 8.3.3.5.3.</p> <p>2) For tolerances on test quantities, see 8.3.2.2.</p> <p>3) For semiconductor switching devices an overload protective device specified by the manufacturer should be used to verify the abnormal conditions.</p> <p>4) Both on-time values (for <math>I_{make}</math> and for <math>I_{break}</math>) shall be at least equal to 2 cycles (or 25 ms for DC-14).</p> <p>5) The value "<math>6 \cdot P</math>" results from an empirical relationship which is found to represent most d.c. magnetic loads to an upper limit of <math>P = 50</math> W, i.e. <math>6 \cdot P = 300</math> ms. Loads having power consumption greater than 50 W are assumed to consist of smaller loads in parallel. Therefore, 300 ms is to be an upper value, irrespective of the power consumption value.</p> <p>For semiconductor switching devices the maximum time constant shall be 60 ms, i.e. <math>T_{0,95} = 180</math> (3 · time constant).</p>									

## 8 Tests

### 8.1 Kinds of test

#### 8.1.1 General

Subclause 8.1.1 of IEC 60947-1 applies.

#### 8.1.2 Type tests

Type tests are intended to verify compliance of the designs of the control circuit devices with this standard.

They comprise the verification of:

- a) temperature-rise (8.3.3.3);
- b) dielectric properties (8.3.3.4);
- c) making and breaking capacities of switching elements under normal conditions (8.3.3.5.2);
- d) making and breaking capacities of switching elements under abnormal conditions (8.3.3.5.3);
- e) performance under conditional short-circuit current (8.3.4);
- f) constructional requirements (8.2);
- g) degree of protection of enclosed control circuit devices (8.3.1).

#### 8.1.3 Routine tests

Routine tests are the responsibility of the manufacturer and are usually limited to a mechanical inspection and a verification of the mechanical operation.

In certain cases specified in Annexes J and K, the inspection is supplemented by a dielectric test.

When performed, the dielectric test is carried out according to 8.3.3.4 with the following amendments: the required minimum duration of voltage application is reduced to about 1 s and the metal foil and external terminal connections are unnecessary.

Additional routine tests for the control switch or the control circuit device may be specified as appropriate. A sampling plan may be accepted.

#### 8.1.4 Sampling tests

Sampling tests shall be performed on time delay devices to verify the time delay or range of time delay as stated by the manufacturer.

NOTE Sampling tests for clearance verification, according to 8.3.3.4.3 of IEC 60947-1 are under consideration.

#### 8.1.5 Special tests

These tests are subject to agreement between manufacturer and user.

They comprise the verification of the durability (see Annex C).

The mechanical and electrical durability tests shall be performed with the actuator operated by a machine that complies with the requirements of 8.3.2.1.

## 8.2 Compliance with constructional requirements

Subclause 8.2 of IEC 60947-1 applies except for 8.2.5 and 8.2.6.

### 8.2.5 Verification of actuating force (or moment)

When required in 7.1.4.3, the minimum actuating force or moment shall be tested during sequence V of 8.3.1. The performance shall be as stated in 7.1.4.3.

### 8.2.6 Verification of limitation of rotation (of a rotary switch)

When this test is required in 7.1.4.4, it shall be tested during sequence VI of 8.3.1. The test sample shall be mounted according to the manufacturer's instructions.

The operation moment shall be measured five times and the maximum value recorded. The maximum moment value, multiplied by five, shall be applied to the actuator by forcing it against the means of limitation. The moment shall be applied for 10 s.

The test is passed if the means of limitation has not moved, become loose or prevented the actuator's normal operation.

## 8.3 Performance

### 8.3.1 Test sequences

The type and sequence of tests to be performed on representative samples are as follows.

- **Test sequence I** (sample No. 1)
  - Test No. 1 – Operating limits of contactor relays (8.3.3.2), if applicable
  - Test No. 2 – Temperature rise (8.3.3.3)
  - Test No. 3 – Dielectric properties (8.3.3.4)
  - Test No. 4 – Mechanical properties of terminals (8.2.4 of IEC 60947-1)
- **Test sequence II** (sample No. 2)
  - Test No. 1 – Making and breaking capacities of switching elements under normal conditions (8.3.3.5.2)
  - Test No. 2 – Dielectric verification (8.3.3.5.5 b))
- **Test sequence III** (sample No. 3)
  - Test No. 1 – Making and breaking capacities of switching elements under abnormal conditions (8.3.3.5.3)
  - Test No. 2 – Dielectric verification (8.3.3.5.5 b))
- **Test sequence IV** (sample No. 4)
  - Test No. 1 – Performance under conditional short-circuit current (8.3.4)
  - Test No. 2 – Dielectric verification (8.3.3.5.5 b))
- **Test sequence V** (sample No. 5)
  - Test No. 1 – Degree of protection of enclosed control circuit devices (Annex C of IEC 60947-1)
  - Test No. 2 – Verification of actuation force or moment (8.2.5)

– **Test sequence VI** (sample No. 6)

Test No. 1 – Measurement of clearances and creepage distances, if applicable (7.1.3)

Test No. 2 – Verification of limitation of rotation of a rotary switch (8.2.6).

There shall be no failure in any of the above tests.

More than one test sequence or all test sequences may be conducted on one sample at the request of the manufacturer. However, the tests shall be conducted in the sequence given for each sample above.

NOTE For class II control circuit devices insulated by encapsulation, additional samples are required (see Annex F). For control circuit devices with integrally connected cables, see Annex G.

### 8.3.2 General test conditions

#### 8.3.2.1 General requirements

Subclause 8.3.2.1 of IEC 60947-1 applies with the following addition:

**A1** The tests shall be performed with the actuator operated by a machine complying with the requirements of 8.3.2.1 a) for linear movement or, for a rotary switch, in accordance with 8.3.2.1 b) or 8.3.2.1 c). **A1**

a) For push-buttons and/or related control switches the operating machine shall apply the actuating force (or moment) to the actuator in the direction of its motion.

The force (or moment) or the travel of the operating machine shall comply with one of the following conditions according to the manufacturer's instructions:

- the maximum force (or moment) exerted on the actuator shall not exceed 1,5 times the force (or moment) required for maximum over-travel of the contact element(s);
- the cover-travel of the contact elements shall be between 50 % and 80 % of the over-travel inherent in the design of the contact elements.

During the whole part of the operating cycle where the contacts move from the open to closed position (or vice versa) or at least at the moment when the switching operation occurs, the velocity of the operating machine, measured where it touches the actuator, shall be between 0,05 m/s and 0,15 m/s.

The mechanical connection between the operating machine and the actuator shall have a sufficient free play (lost motion) to avoid the operating machine impeding the free motion of the actuator away from it.

b) For switches fully rotary in both directions, one operating cycle comprises either one fully clockwise operation of the actuator or one fully anticlockwise operation of the actuator. However, in this case approximately three-quarters of the total number of operating cycles shall be made in the clockwise direction, followed by the remainder in the anticlockwise direction. The angular velocity shall be between 0,5 to 1 revolution per second.

**A1** c) For limited movement rotary switches, operation shall be at a speed of 1 to 4 revolutions per second. **A1**

#### 8.3.2.2 Test quantities

Subclause 8.3.2.2 of IEC 60947-1 applies except for 8.3.2.2.3.

### **8.3.2.3 Evaluation of test results**

The condition of the control circuit device after each test shall be checked by the verifications applicable to each test.

A control circuit device is deemed to have met the requirements of this standard if it meets the requirements of each test and/or test sequence as applicable.

### **8.3.2.4 Test reports**

Subclause 8.3.2.4 of IEC 60947-1 applies.

## **8.3.3 Performance under no-load, normal load and abnormal load conditions**

### **8.3.3.1 Operation**

Subclause 8.3.3.1 of IEC 60947-1 applies.

### **8.3.3.2 Operating limits of contactor relays**

The operating limits of contactor relays shall be in accordance with the standard applicable to contactors (see IEC 60947-4-1).

### **8.3.3.3 Temperature rise**

Subclause 8.3.3.3 of IEC 60947-1 applies with the following addition:

All switching elements of the control circuit device shall be tested. All switching elements that may be simultaneously closed shall be tested together. However, switching elements forming an integral part of an actuating system in such a manner that the elements cannot remain in the closed position are exempt from this test.

NOTE Several temperature-rise tests may be necessary if the control circuit device has several positions in which switching elements are in their closed position.

The minimum length of each temporary connection, from terminal to terminal, shall be 1 m.

### **8.3.3.4 Dielectric properties**

Subclause 8.3.3.4 of IEC 60947-1 applies with the following addition.

For Class II control circuit devices insulated by encapsulation, see Annex F.

#### **8.3.3.4.1 Type tests**

Subclause 8.3.3.4.1 of IEC 60947-1 applies with the following addition.

Add, after the second paragraph of 3) c):

The control circuit device shall be capable of withstanding the test voltage applied as follows:

- between live parts of the switching element and parts of the control switch intended to be earthed;

- between live parts of the switching element and surfaces of the control switch likely to be touched in service, conductive or made conductive by a metal foil;
- between live parts belonging to electrically separated switching elements.

### 8.3.3.5 Making and breaking capacities

Tests for verification of making and breaking capacities shall be made according to the general test requirements stated in 8.3.2.1.

#### 8.3.3.5.1 Test circuits and connections

Tests shall be carried out on a single-pole element or on one pole of a multi-pole device provided that all pole elements are identical in construction and operation.

Adjacent contact elements are considered to be of the opposite polarity unless otherwise stated by the manufacturer.

Change-over contacts of forms C and Za are of the same polarity and change-over contacts of form Zb are of the opposite polarity.

Single-pole elements or contact elements in a multi-pole device stated as the same polarity shall be connected in accordance with the circuit shown in Figure 5. Any adjacent contact elements not being tested shall not be connected.

Change-over contacts of forms C and Za shall be subject to separate tests in the normally open and normally closed positions connected in accordance with Figure 5.

Contact elements of the opposite polarity shall be connected in accordance with the circuit shown in Figure 6. Adjacent contact elements of the opposite polarity not being tested shall be jointly connected to the supply, as shown.

Change-over contacts of form Zb shall be subject to separate tests in the normally open and normally closed positions but with both terminals of the opposite position being connected to the supply, as shown in Figure 6, for an adjacent contact of opposite polarity.

If the make and break operations require different values, the circuit shown in Figure 7 shall represent load  $L_d$  in Figures 5 and 6.

For a.c. tests:

The load shall be an air-cored inductor in series with a resistor, if needed, to obtain the specified power factor. The inductor shall be shunted by a resistor taking 3 % of the total power consumed (see Figure 7).

For d.c. tests:

To obtain the specified steady-state current the test current shall increase from zero to the steady-state value within the limits shown in Figure 9. For guidance, an example of an iron-cored load is shown in Annex B.

Test voltage and test current shall be in accordance with Tables 4 and 5. The test circuit applied shall be stated in the test report.

#### 8.3.3.5.2 Making and breaking capacities of switching elements under normal conditions

The tests are intended to verify that the control circuit device is capable of performing its intended duty according to the utilization category.

With the load set in accordance with Table 4, the 6 050 operating cycles shall be carried out in the following sequence:

- 50 operations at 10 s intervals with the voltage set at  $1,1 U_e$ ;
- 10 operations as rapidly as possible whilst ensuring complete closing and opening of contacts;
- 990 operations at 1 s intervals;
- 5 000 operations at 10 s intervals (or at a shorter interval determined by the manufacturer). <sup>(A1)</sup>

When the construction of the device is such that rapid cycling is not possible, for example overload relay contacts, the operations shall be at 10 s intervals or as fast as the device will permit.

For auxiliary contacts of a switching device, for example contactor, circuit-breaker, the number of operating cycles shall be the same as that required for the verification of the conventional operational performance capability of the switching device (see appropriate product standard).

#### 8.3.3.5.3 Making and breaking capacities of switching elements under abnormal conditions

The test is intended to verify that the control circuit device is capable of making and breaking currents associated with electromagnetic loads. Load values, together with the sequence of operations shall be in accordance with Table 5.

#### 8.3.3.5.4 Vacant

#### 8.3.3.5.5 Results to be obtained

- a) During the tests of 8.3.3.5.2 and 8.3.3.5.3 there shall be no electrical or mechanical failures, no contact welding or prolonged arcing, and the fuses shall not blow.
- b) After the test of 8.3.3.5.2 and 8.3.3.5.3 the device shall withstand the power-frequency test voltage of  $2 U_e$ , but not less than 1 000 V, applied as specified in 8.3.3.4.1.

### 8.3.4 Performance under conditional short-circuit current

#### 8.3.4.1 General conditions for short-circuit tests

The switching element shall be in a new and clean condition, mounted as in service.

#### 8.3.4.2 Test procedure

The switching element may be operated several times before the test, at no load or at any current not exceeding the rated current.

A contact element with two terminals shall be tested with the actuator in the position corresponding to the closed position of the switching element under test.



The contact element to be tested shall be in series with the short-circuit protective device (SCPD), the load impedance, and a separate switching device in a single-phase circuit as shown in Figure 8. The test quantities shall be in accordance with 8.3.4.3.

The test is performed by making the current with the separate making switch and the current shall be maintained until the SCPD operates.

The test shall be performed three times on the same contact element, the SCPD being reset or replaced after each test. The time interval between the tests shall be not less than 3 min. The actual time interval shall be stated in the test report.

For change-over contact elements, the above test shall be made separately on both the normally closed and normally open contacts.

NOTE For control switches with both two terminals and change-over contact elements, both types should be tested.

A separate control circuit device may be used for each contact element.

#### **8.3.4.3 Test circuit and test quantities**

The switching element shall be connected in series with the short-circuit protective device of type and rating stated by the manufacturer; it shall also be in series with the switching device intended to close the circuit.

- Ⓐ) The test circuit load impedance shall be an air-cored inductor in series with a resistor, adjusted to a prospective current of 1 000 A, or another value if stated by the manufacturer but not less than 100 A, at a power factor of between 0,5 and 0,7 and at the rated operational voltage. Ⓐ) No parallel damping load shall be added. The open circuit voltage shall be 1,1 times the maximum rated operational voltage of the switching element.

The switching element shall be connected in the circuit using 1 m total length of cable corresponding to the operational current of the switching element.

#### **8.3.4.4 Condition of the switching element after the test**

- a) After the short-circuit test it shall be possible to open the switching elements by the normal actuating system.
- b) After the test the device shall withstand the power-frequency voltage of  $2 U_e$  but not less than 1 000 V applied as specified in 8.3.3.4.1.







Number of the example	Disposition of the contact element(s)	Actuator positions					
		1	2	3	4	5	
1		x					Contact element closed in actuator position No. 1 only.
2			x		x	x	Contact element closed in actuator positions No. 2, 4 and 5.
3			x				Two contact elements used as change-over contact elements with 3 terminals.
4			x				Contact element with pulse (fleeting) contact closed between actuator positions No. 2 and 3.
5		x	x		x	x	Contact element with pulse (fleeting) contact open between actuator positions No. 3 and 4.
6					x	x	Contact element with maintained contact between actuator positions No. 4 and 5.
7		x					Two contact elements with close-before-open contacts between actuator positions No. 1 and 2.
8		x					Two contact elements with open-before-close contacts between actuator positions No. 1 and 2 (*).
9	A  B 	x		x			Operation in which contact element B is arranged to close before and open after contact element A.
(*) Open-before-close contact elements may be used to break the current in one circuit before making the current in the other circuit, provided the time interval be properly related to the circuit conditions.							

Figure 1 – Examples of the recommended method for drawing an operating diagram of a rotary switch

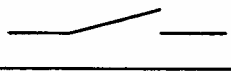

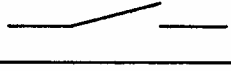
IEC 903/97

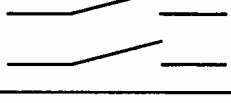
- a* Pre-travel of the actuator
- b* Pre-travel of the contact element
- c* Minimum value required to give adequate contact gap
- d* Over-travel of the contact element

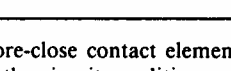
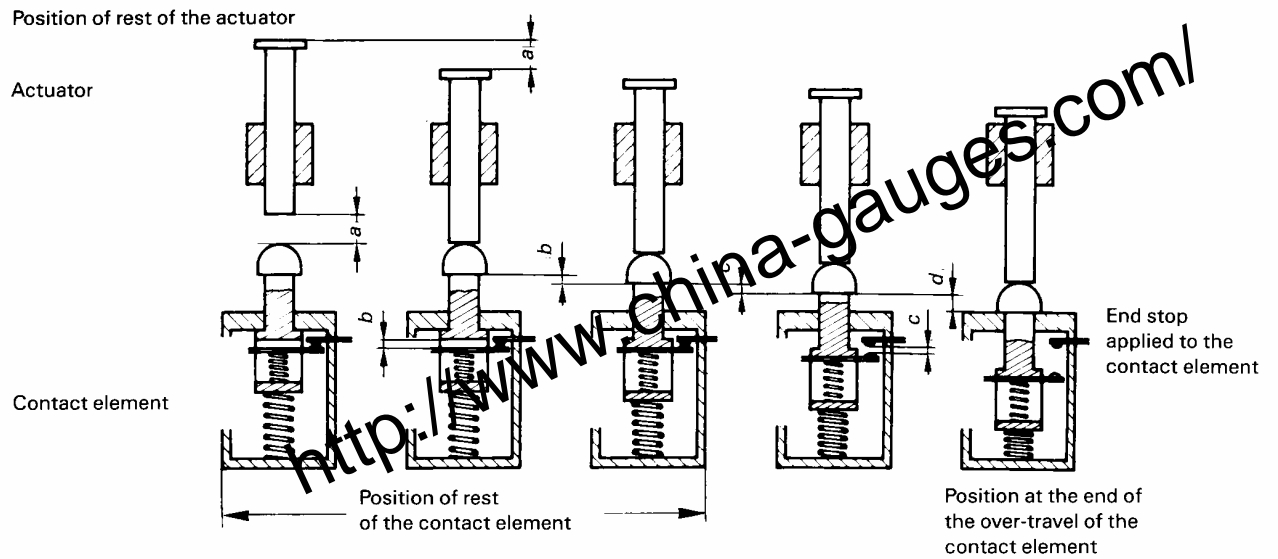
$b + c + d$  Total travel of the contact element

$a + b + c + d + e)^*$  Total travel of the actuator

\*NOTE Because of a possible resilient connection between the actuator and the contact element (for example, see Figure 3), the over-travel of the actuator may exceed the over-travel of the contact element by a length *e*.

**Figure 2 – Operation of push-buttons**

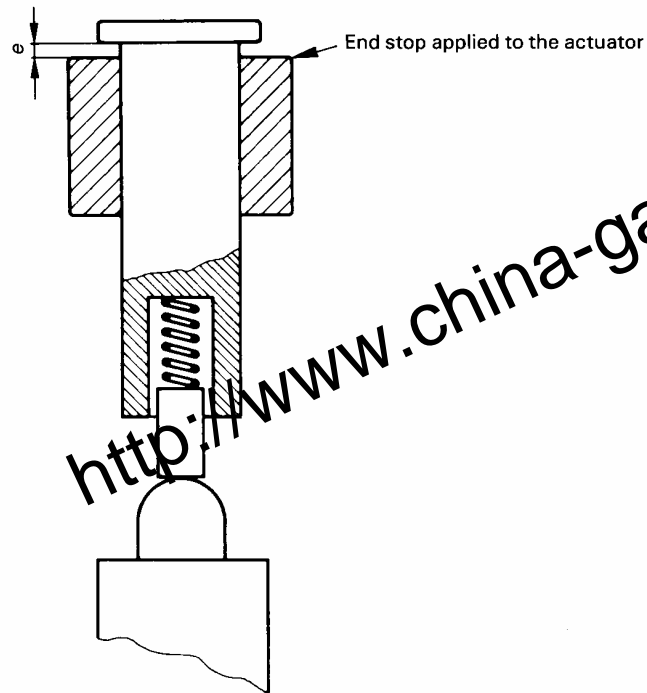

IEC 904/97

Figure 3 – Difference  $e$  between the over-travel of the actuator and that of the contact element

Figure No.	Figure	Symbols	Forms	Description
4a)		 Note 1	A	Single gap contact element with two terminals
		 Note 1	B	
4b)		 Note 1	X	Double gap contact element with two terminals
		 Note 1	Y	
4c)		 Note 1	C	Change-over, single gap, contact element with three terminals
4d)		 Note 1	Za	Change-over, double gap, contact element with four terminals Note – The contacts are of the same polarity
4e)		 Note 1	Zb	Change-over, double gap, contact element with four terminals (The two moving contacts are electrically separated) <b>[A1]</b> Note Multiple electrically separated contact configurations are also covered by Zb. <b>[A1]</b>

IEC 905/97

NOTE 1 Symbols according to IEC 60617.

Figure 4 – Examples of contact elements (schematic sketches)

Test circuits  
 (see 8.3.3.5)  
 Multi-pole control switches

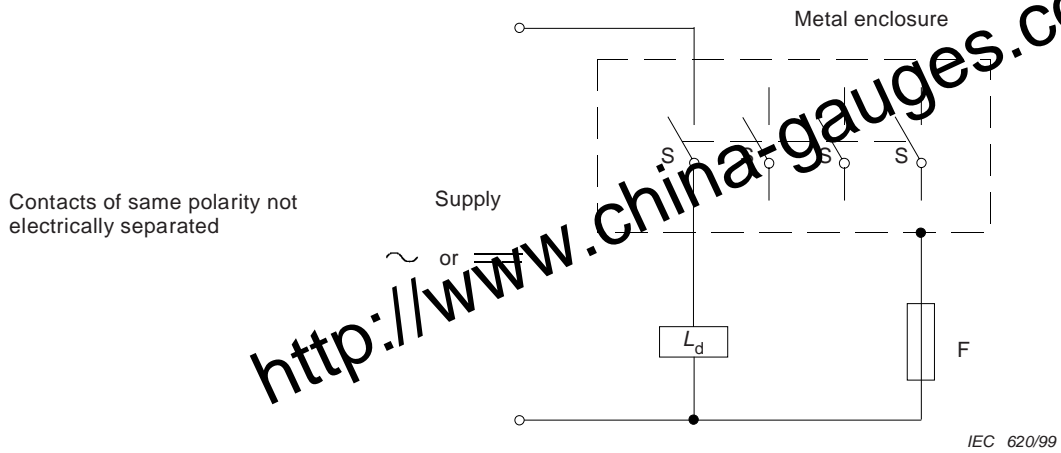

- $L_d$ : Load according to Figure 7
- F: Fuse or isolation measurement device
- S: Contact element (NO or NC)

**Figure 5 – Test circuits for multi-pole control switches –  
 Contacts of same polarity, not electrically separated**

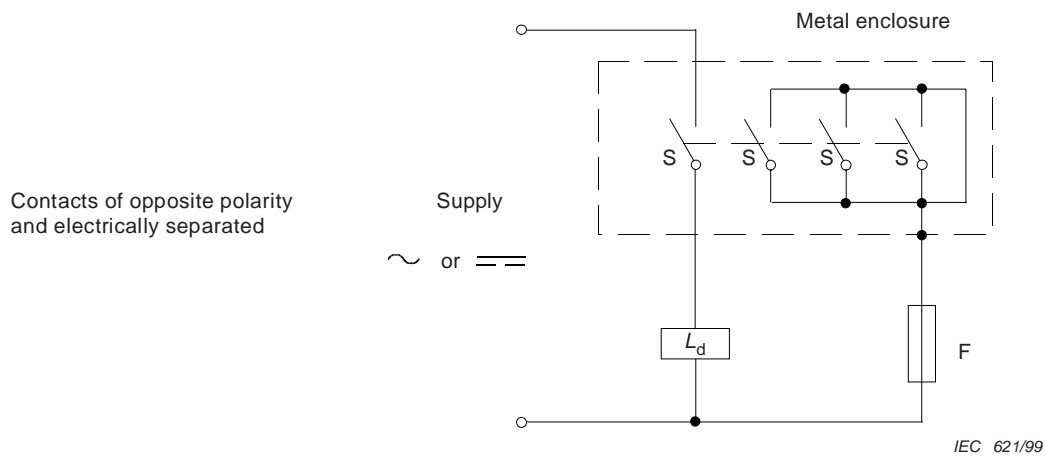

- $L_d$ : Load according to Figure 7
- F: Fuse or isolation measurement device
- S: Contact element (NO or NC)

**Figure 6 – Test circuits for multi-pole control switches –  
 Contacts of opposite polarity, and electrically separated**

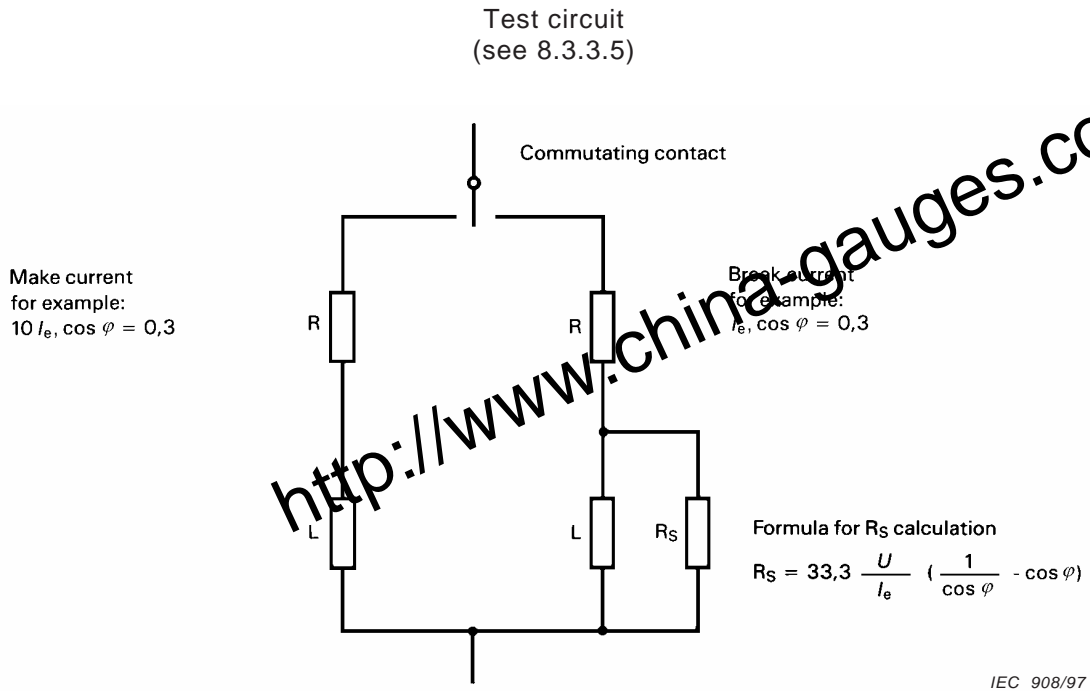

Figure 7 – Load  $L_d$  details for test conditions requiring different values of make and break current and/or power factor (time constant)

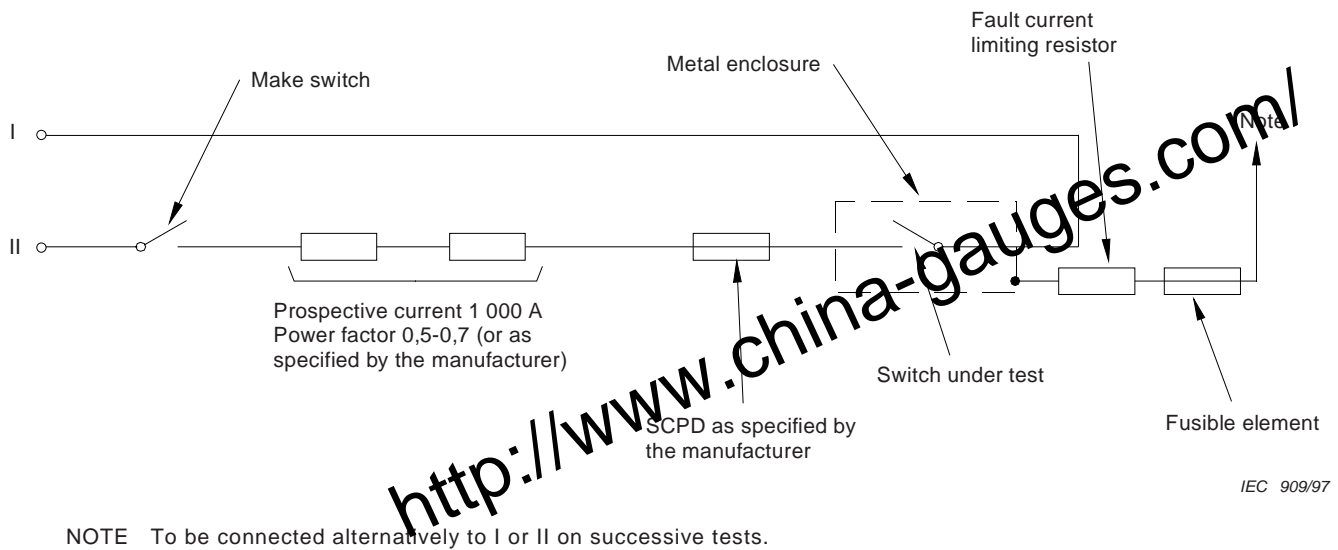

Figure 8 – Test circuit, conditional short-circuit current (see 8.3.4.2)

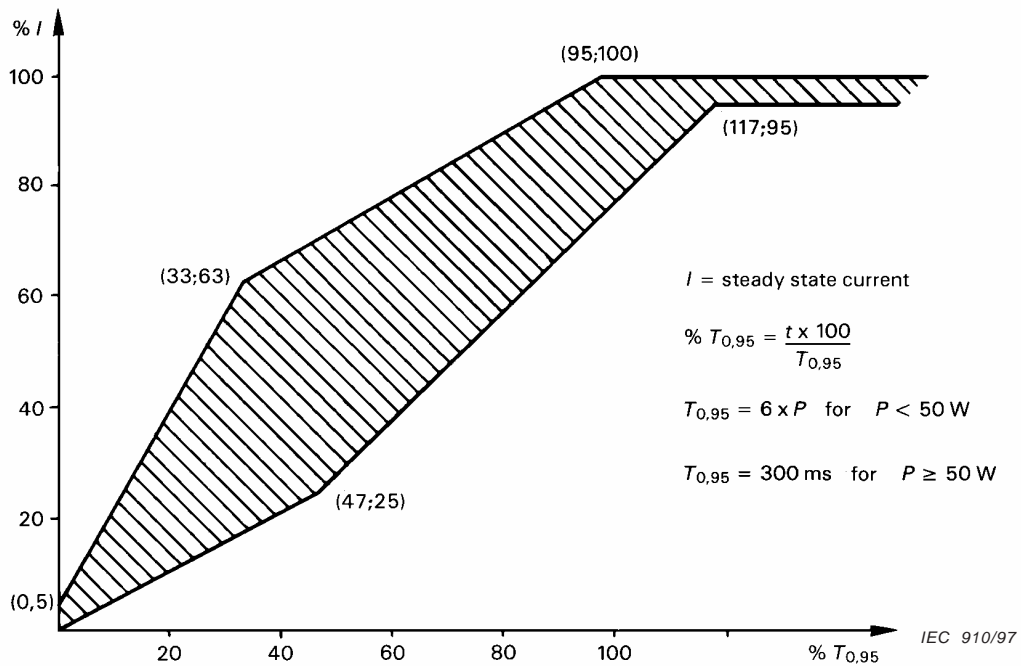

Figure 9 – Current/time limits for d.c. test loads (see 8.3.3.5.3)



Annex A  
(normative)Electrical ratings based on utilization categories  
(see 3.1)

Table A.1 – Examples of contact rating designation based on utilization categories

Designation <sup>1)</sup>	Utilization category	Conventional enclosed thermal current $I_{the}$ (A)	Rated operational current $I_e$ (A) at rated operational voltage $U_e$						VA rating	
			120 V	240 V	380 V	480 V	500 V	600 V	M	B
<i>Alternative current</i>			120 V	240 V	380 V	480 V	500 V	600 V	M	B
A150	AC-15	10	6	–	–	–	–	–	7 200	720
A300	AC-15	10	6	3	–	–	–	–	7 200	720
A600	AC-15	10	6	3	1,9	1,5	1,4	1,2	7 200	720
B150	AC-15	5	3	–	–	–	–	–	3 600	360
B300	AC-15	5	3	1,5	–	–	–	–	3 600	360
B600	AC-15	5	3	1,5	0,95	0,75	0,72	0,6	3 600	360
C150	AC-15	2,5	1,5	–	–	–	–	–	1 800	180
C300	AC-15	2,5	1,5	0,75	–	–	–	–	1 800	180
C600	AC-15	2,5	1,5	0,75	0,47	0,375	0,35	0,3	1 800	180
D150	AC-14	1,0	0,6	–	–	–	–	–	432	72
D300	AC-14	1,0	0,6	0,3	–	–	–	–	432	72
E150	AC-14	0,5	0,3	–	–	–	–	–	216	36
<i>Direct current</i>			125 V	250 V	400 V	500 V	600 V			
N150	DC-13	10	2,2	–	–	–	–	–	275	275
N300	DC-13	10	2,2	1,1	–	–	–	–	275	275
N600	DC-13	10	2,2	1,1	0,63	0,55	0,4	–	275	275
P150	DC-13	5	1,1	–	–	–	–	–	138	138
P300	DC-13	5	1,1	0,55	–	–	–	–	138	138
P600	DC-13	5	1,1	0,55	0,31	0,27	0,2	–	138	138
Q150	DC-13	2,5	0,55	–	–	–	–	–	69	69
Q300	DC-13	2,5	0,55	0,27	–	–	–	–	69	69
Q600	DC-13	2,5	0,55	0,27	0,15	0,13	0,1	–	69	69
R150	DC-13	1,0	0,22	–	–	–	–	–	28	28
R300	DC-13	1,0	0,22	0,1	–	–	–	–	28	28
									M = make	B = break

NOTE 1 The letter stands for the conventional enclosed thermal current and identifies (a.c. or d.c.): for example B means 5 A a.c. The rated insulation voltage  $U_i$  is at least equal to the number after the letter.

NOTE 2 The rated operational current  $I_e$  (A), the rated operational voltage  $U_e$  (V) and the break apparent power B (V.A) are correlated by the formula  $B = U_e \cdot I_e$ .

Table A.2 – Examples of semiconductors switching element ratings  
for 50 Hz and/or 60 Hz <sup>1)</sup>

Switching element rating Designation	Rated operational current $I_e$ A	Rated make current A				Minimum operational current A	Maximum OFF-state current mA
		AC15	AC14	AC13	AC12		
SA	10	100	60	20	10		15
SB	5	50	30	10	5	0,1	15
SC	2	20	12	4	2	0,05	10
SD	1	10	6	2	1	0,05	10
SE	0,5	5	3	1	0,5	0,01	10
SF	0,25	2,5	1,5	0,5	0,25	0,01	5
SG	0,1		0,6	0,2	0,1	0,01	3

<sup>1)</sup> The rated operational voltage shall be specified by the manufacturer.

Table A.3 – Examples of semiconductors switching element ratings for d.c. <sup>1)</sup>

Switching element rating Designation	Rated operational current $I_e$ A	Rated make current A			Maximum OFF-state current mA
		DC14	DC13	DC12	
SN	10	100	10	10	5
SP	5	50	5	5	4
SQ	2	20	2	2	4
SR	1	10	1	1	2
SS	0,5	5	0,5	0,5	2
ST	0,25	2,5	0,25	0,25	1
SU	0,1	1	0,1	0,1	0,4
SV	0,05	0,5	0,05	0,05	0,2

<sup>1)</sup> The rated operational voltage shall be specified by the manufacturer.

## Annex B (normative)

### Example of inductive test loads for d.c. contacts

#### B.1 General

The direct current inductive loads found in control circuits are usually electromagnetically driven relays, contactors and solenoids with solid iron loads rated 50 W or less. The influence of these loads on the contacts of the control circuit device is determined by the stored energy of the inductor which, in turn, is related to the average rate of rise of the current in the inductor or to the charging time of the inductor.

It has been empirically determined that inductive loads up to 50 W almost always have a charging time ( $T_{0,95}$ ) to 95 % of their full current value of 6 ms per watt or less.

#### B.2 Construction

The following inductive test loads may be used to approximate the loads imposed upon contacts used in d.c. control circuits:

The magnetic circuit consists of two solid steel cores, 44,5 mm in diameter and 158,7 mm long, which are fastened by screws at each end to solid steel yokes 25,4 mm · 63,5 mm · 152,4 mm on 101,6 mm centres (see Figure B.1). The steel has a resistance of between 13,3 and 19,9  $\Omega$ /cm. (Cold-finished low carbon steels such as AISI 1010, 1015, 1018 or 116 equivalent meet this requirement.) At one end of each core, a non-magnetic spacer having a thickness adjustable to between 0,127 mm and 0,762 mm is interposed between the end of the core and the yoke. Non-magnetic screws shall be used to hold the yoke at the end having the non-magnetic spacer, and steel screws shall be used at the other end.

A coil having the winding characteristics shown in Figure B.1 surrounds one of the cores. The current in the coil, when energized at the test voltage, is adjusted to the value specified in the Table B.1 by means of a series resistor.

The thickness of the spacer is adjusted so that the coil current builds up from zero to 95 % of its full value within the limits shown in Figure 9. If the current curve falls below the minimum time limit, the cross section of the iron yoke is increased and if it falls above the maximum limit the cross section is reduced.

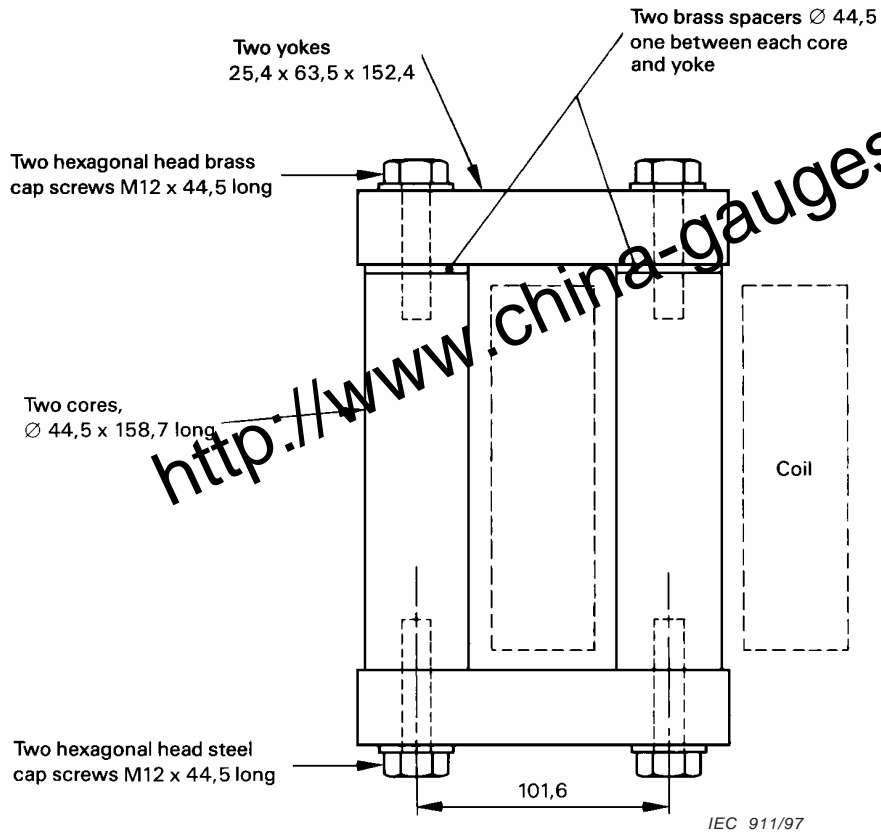

Dimensions in millimetres

Figure B.1 – Construction of load for d.c. contacts

Table B.1 – DC loads

Coil construction					
Test voltage V	Number of turns	Wire size mm <sup>2</sup>	Approximate coil resistance .	Current limit with series resistor A	Wattage at test voltage W
125	7 000	0,52	74	1,1	138
250	14 000	0,26	295	0,55	138
600	33 400	0,10	1 680	0,20	120

## Annex C (normative)

### Special tests – Durability tests

#### C.1 General

##### C.1.1 Durability declaration

The special durability tests (see 7.2.4.3) described in this annex are conducted at the discretion of the manufacturer. If the manufacturer declares a mechanical and/or electrical durability, the value shall correspond to the special tests described respectively in C.2 and/or C.3.

NOTE Both durability types apply to the complete control circuit device.

Both durability types are expressed as a number of operating cycles (see C.2.1 and/or C.3.1).

The preferred numbers of operating cycles declared for any type of durability are the following: 0,01 – 0,03 – 0,1 – 0,3 – 1 – 3 – 10 – 30 or 100 millions.

##### C.1.2 Test procedures

###### C.1.2.1 General

Every test shall be performed under the general conditions stated in 8.3.2.1, and at a rate equal or higher than that declared by the manufacturer. The moving parts of the device shall reach their maximum operating positions in both directions, as recommended by the manufacturer.

The test results are verified by statistical analysis according to the *single 8* (see C.1.2.2) or *double 3* (see C.1.2.3) test methods.

The manufacturer may declare mechanical durability based on experience with similar design.

NOTE The *single 8* or *double 3* test methods are both given in IEC 60410 (see Tables X-C-2 and X-D-2). These two tests have been chosen with the objective of testing a limited number of control circuit devices on the same statistical characteristics (acceptance level: 10 %). Other methods providing the 10 % acceptance level may be used.

###### C.1.2.2 Single 8 test

Eight control circuit devices shall be tested to the declared number of operating cycles.

If the number of failed devices does not exceed two, the test is considered passed.

###### C.1.2.3 Double 3 test

Three control circuit devices shall be tested to the declared number of operating cycles.

The test is considered passed if there is no failure, and failed if there is more than one failure. Should there be only one failure, then three additional control circuit devices are tested to the declared number of operating cycles and providing there is no additional failure, the test is considered passed.

### **C.1.3 Failure criteria**

During the tests described in C.2.2 and C.3.2, there shall be no electrical and/or mechanical failures. Following the tests, the switching element shall pass the dielectric test of 8.3.3.4 with a rated test voltage equal to  $2 U_e$  with a minimum of 1 000 V.

## **C.2 Mechanical durability**

### **C.2.1 General**

The mechanical durability of a control circuit device is defined as the number of no-load operating cycles which will be attained or exceeded by 90 % of all devices tested without repair or replacement of any part.

### **C.2.2 Test procedures**

Tests are carried out according to C.1.2.

During the test, periodically the contacts shall be checked at any voltage and current, selected by the manufacturer, and there shall be no failure (see C.1.3).

## **C.3 Electrical durability**

### **C.3.1 General**

The electrical durability of a control circuit device is defined as the number of on-load operating cycles which will be attained or exceeded by 90 % of all devices tested, without repair or replacement of any part.

### **C.3.2 Test procedures**

Electrical durability tests are carried out by operating the device under the conditions defined in Table C.1, in accordance with C.3.2.1 for a.c. or with C.3.2.2 for d.c.

Each mechanical operating cycle shall include an interruption of test current.

The ON-duration of current shall be not more than 50 % and not less than 10 % of an operating cycle. If the test circuit shown in Figure C.1 is used, the ON-duration of current at ten times  $I_e$  shall not cause overheating.

Alternatively these tests may be performed on the actual load for which the control switch is intended.

Table C.1 – Making and breaking conditions for electrical durability

Kind of current	Utilization category	Make			Break		
		$I$	$U$	$\cos \phi$	$I$	$U$	$\cos \phi$
Alternating	AC-15	$10 I_e$	$U_e$	0,7 <sup>1)</sup>	$I_e$	$U_e$	0,4 <sup>1)</sup>
		$I$	$U$	$T_{0,95}$	$I$	$U$	$T_{0,95}$
Direct <sup>2)</sup>	DC-13	$I_e$	$U_e$	$6 \cdot P$	$I_e$	$U_e$	$6 \cdot P$ <sup>3)</sup>
		$I$	$U$	$T_{0,95}$	$I$	$U$	$T_{0,95}$

$I_e$  Rated operational current  
 $U_e$  Rated operational voltage  
 $P = U_e \cdot I_e$  Steady-state power consumption, in W  
 $T_{0,95}$  Time to reach 95 % of the steady-state current, in milliseconds

1) The power-factors indicated are conventional values and apply only to the test circuits which simulate the electrical characteristics of coil circuits. It should be noted that, for circuits with power-factor 0,4, shunt resistors are used in the test circuit to simulate the damping effect on the eddy current losses of the actual electromagnet.  
 2) For d.c. electromagnetic loads provided with switching devices introducing an economy resistor, the rated operational current shall be at least equal to the maximum value of the inrush current.  
 3) The value " $6 \cdot P$ " results from an empirical relationship which is found to represent most d.c. magnetic loads to an upper limit of  $P = 50$  W, i.e.  $6 \cdot P = 300$  ms. Loads having power consumption greater than 50 W are assumed to consist of smaller loads in parallel. Therefore, 300 ms is to be an upper value, irrespective of the power.

### C.3.2.1 AC tests

The circuit to be used shall be as shown in Figure C.1 below, comprising

- a making circuit, consisting of an air-cored inductor, in series with a resistor, having a power factor of 0,7 and drawing a current of  $10 I_e$ ;
- a breaking circuit, consisting of an air-cored inductor in series with a resistor, the whole being in parallel with a resistor in which flows about 3 % of the breaking current  $I_e$ , so that the total power factor be of 0,4.

If the contact element has a bounce time less than 3 ms, the test may be made with the simplified circuit shown in Figure C.2.

The test report shall record which test circuit has been used.

### C.3.2.2 DC tests

Circuits to be used shall consist of:

- a) an air-cored inductor in series with a resistor.  
A resistor shall be connected across the complete test circuit to simulate the damping due to eddy currents; the resistance value shall be such that 1 % of the test current will pass through this resistor; or,
- b) an iron-cored inductor, in series with a resistor, if required, to obtain a duration  $T_{0,95}$  as indicated in Table C.1.

It shall be verified, by oscillograms, that the time to reach 95 % of the steady-state current is equal to the value given in Table C.1  $\pm 10\%$ , and the time to reach 63 % of the steady-state current is one-third of the value given in Table C.1  $\pm 20\%$ .

AC test circuits (see C.3.2.1)

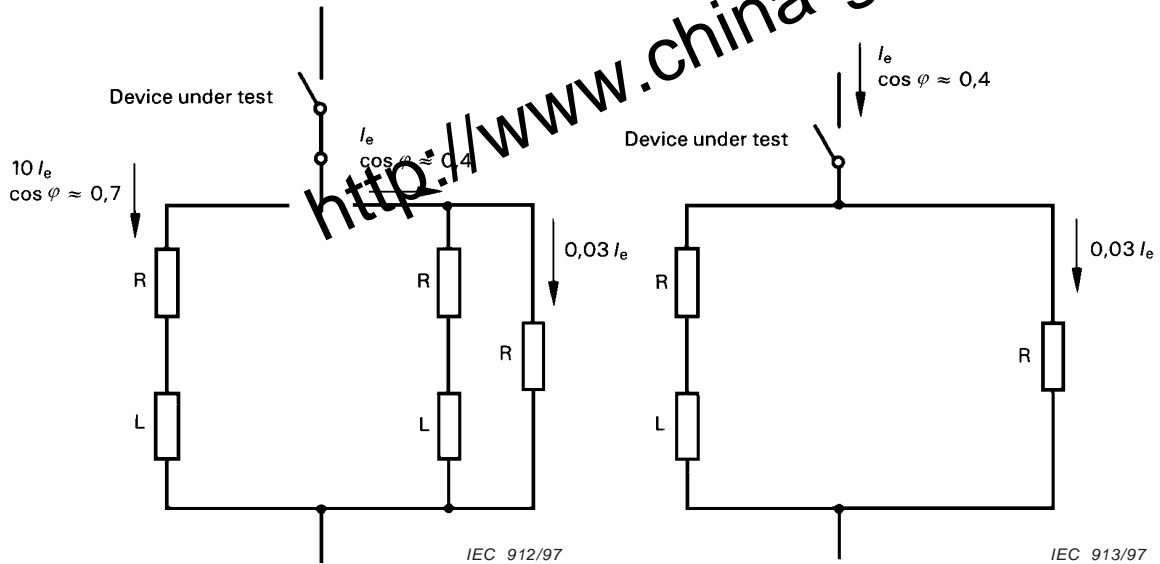

**Figure C.1 – Normal circuit**  
(see C.3.2.1)

**Figure C.2 – Simplified circuit**  
(see C.3.2.1)



**Annex D – Vacant**

<http://www.china-gauges.com/>

## Annex E (normative)

### Items subject to agreement between manufacturer and user

NOTE For the purpose of this annex:

- "agreement" is used in a very wide sense.
- "user" includes testing stations.

Annex J of IEC 60947-1 applies, as far as concerned by clauses and of this standard, with the following additions:

Clause or subclause number of this standard	Item
5.2.5	Relationship between the positions of the actuator of rotary switches and the associated contact element positions in the operating diagram (indication by the manufacturer)
5.2.6	Characteristics of the delay of time-delay contact elements with adjustable delay of contactors relays (indication by manufacturer)
6.1.1 (Annex K)	Choice of connecting conductors for position switches with direct opening action
8.3.1	Test sequences made on one sample only (at the manufacturer's request)
8.3.4.3	Conditional short-circuit current test: <ul style="list-style-type: none"> <li>– adjustment of the test circuit if the prospective current is different from 1 000 A (to be specified by the manufacturer)</li> <li>– power factor of the test circuit less than 0,5 (with the manufacturer's consent)</li> </ul>

**Annex F**  
(normative)**Class II control circuit devices insulated by encapsulation**  
**Requirements and tests****F.1 General**

This annex specifies constructional requirements and tests for class II control circuit devices or parts of devices in which insulation of class II according to IEC 61140 is achieved by encapsulation.

All non-encapsulated parts shall have clearances and creepage distances double to those specified in 7.1.3.

**F.2 Definitions**

For the purposes of this annex, the following definitions apply:

**F.2.1**  
**encapsulation**

process by which all components, conductors and ends of integral cables are encased in an insulating compound by suitable means such as embedding or potting

**F.2.1.1**  
**embedding**

process of completely encasing electrical device(s) by pouring a compound over it (them) in a mould, and removing the encased device(s) from the mould after solidification of the compound

**F.2.1.2**  
**potting**

embedding process in which the mould remains attached to the encased electrical device(s)

**F.2.2**  
**compound**

thermosetting, thermoplastic, catalytically cured and elastomeric materials with or without fillers and/or additives, after their solidification

**F.2.3**  
**temperature range of the compound**

the ambient temperature range stated in 6.1.1 of IEC 60947-1

**F.5 Marking**

Control devices according to this annex shall be marked with the following symbol



This symbol is 60417-2-IEC-5172.

## F.7 Instructional and functional requirements

### F.7.1 Choice of compound

The compound shall be chosen so that the encapsulated control devices comply with the tests defined in F.8.

### F.7.2 Adhesion of the compound

The adhesion of the compound shall be sufficient to prevent the ingress of moisture between the compound and all encapsulated parts and to prevent movement of the encapsulated portion of the cable if any.

Compliance shall be verified by tests of F.8.1.2.5 and F.8.1.2.2.

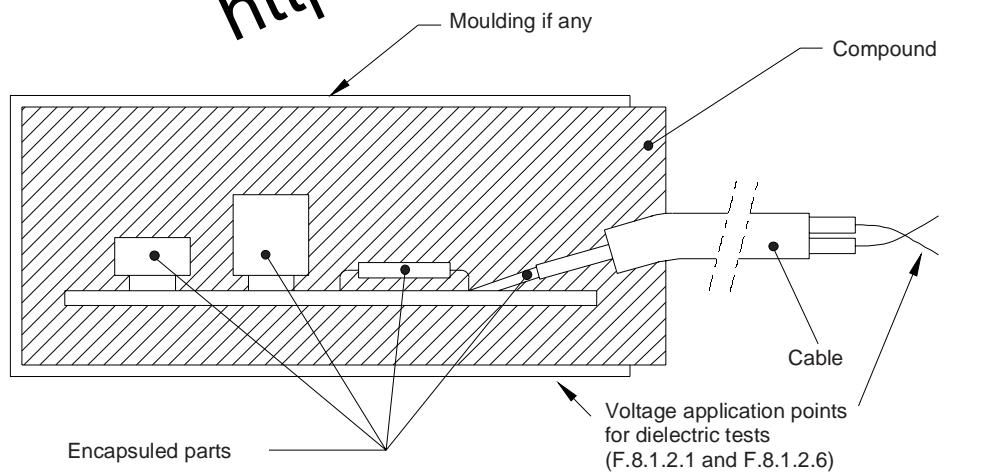

IEC 288/94

Figure F.1 – Insulation by encapsulation

### F.7.3 Dielectric properties

Subclause 7.2.3 applies with the following changes.

For the verification of the impulse withstand voltage, the test voltage  $U_{imp}$  shall be the next higher category of the maximum rated operational voltage in the first column of Table H.1 of IEC 60947-1 for the stated overvoltage category.

For the verification of the power frequency withstand voltage, the test voltage shall be the sum of the voltage stated in Table 12A of IEC 60947-1 plus 1 000 V.

## F.8 Tests

### F.8.1 Kind of tests

#### F.8.1.1 General

Subclause 8.1.1 of IEC 60947-1 applies.

#### F.8.1.2 Type test

The following sequence of 6 tests shall be applied to each of 3 samples in the specified order.

**F.8.1.2.1 Dielectric tests in new conditions**

Subclause 8.3.3.4 of IEC 60947-1 applies with the exception that the values of voltages shall be applied between the stripped joined ends of the cable or the shorted terminals and any point of the surface (or metallic foil on the surface) of the encapsulated device (see Figure F.1). No breakdown of the insulation shall occur.

**F.8.1.2.2 Cable tests (if applicable)**

Control circuit devices provided with integrally connected cables shall comply with requirements of Annex G.

**F.8.1.2.3 Rapid change of temperature test**

Test Na shall be performed in accordance with IEC 60068-2-14 with the following values:

$T_A$  and  $T_B$  are the minimum and the maximum temperatures stated in F.2.3

Transition time  $t_2$ : 2 min to 3 min

Number of cycles: 5

Exposure time  $t_1$ : 3 h

After the test no visible damage shall be observed.<sup>1)</sup>

**F.8.1.2.4 Impact test**

The test is performed as follows (see Figure F.2). The sample is placed on a rigid support.

Three impacts of 0,5 J shall be applied near the centre of the largest surface or the longest axis (for cylindrical shape) of the encapsulated device.

The impacts are provided by dropping a steel ball of 0,25 kg from a height of 0,20 m.

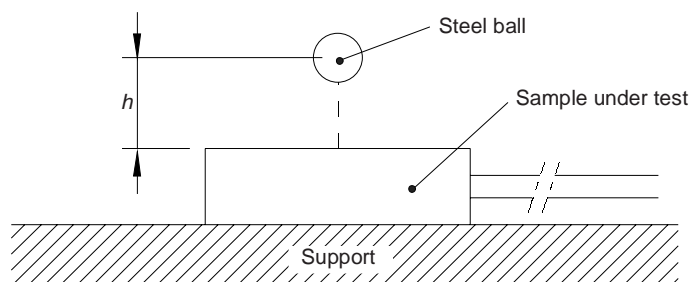

IEC 289/94

**Figure F.2 – Test apparatus**

The support is considered sufficiently rigid if its displacement under the impact energy is lower than 0,1 mm.

<sup>1)</sup> Small cracks of the moulding compounds, if any (see Figure F.1) are acceptable after tests F.8.1.2.3, F.8.1.2.4 and F.8.1.2.5. They shall not impair the results of the final test of F.8.1.2.6.

After test no visible damage shall be observed.<sup>1)</sup>

#### **F.8.1.2.5 Damp heat, cyclic**

The test Db shall be performed according to IEC 60068-2-30 with the following values:

Upper temperature: 55 °C

Number of cycles: 6

The test report shall state which variant is applied: variant 1 or variant 2.

After the test no visible damage shall be observed.<sup>1)</sup>

#### **F.8.1.2.6 Dielectric test after stresses**

Following Test F.8.1.2.5, the dielectric properties shall be checked by repeating tests specified in 8.3.3.4 with the test voltage of power-frequency withstand voltage being applied for 5 s.

The results to be obtained shall be as stated in 8.3.3.4 with the addition that the leakage current shall not exceed 2 mA at 1,1  $U_i$ .

#### **F.8.1.3 Routine tests**

Subclause 8.1.3 applies but the dielectric test is mandatory.

---

<sup>1)</sup> Small cracks of the moulding compounds, if any (see Figure F.1) are acceptable after tests F.8.1.2.3, F.8.1.2.4 and F.8.1.2.5. They shall not impair the results of the final test of F.8.1.2.6.

## Annex G (normative)

### Additional requirements for control circuit devices with integrally connected cables

#### G.1 General

This annex gives additional requirements applying to control circuit devices with integrally connected cables for electrical connection to other equipment and/or to the power source.

The cable integrally connected to such control circuit devices is not considered replaceable by the user. This annex states the constructional and performance requirements for the cable, the cable anchorage and the cable entrance seal.

#### G.2 Definitions

For the purpose of this annex, the following definitions apply:

##### G.2.1

##### **cable connected control circuit device**

control circuit devices having integrally connected leads for electrical connection to other equipment and/or to the power source

##### G.2.2

##### **cable entrance sealing means**

sealing means between the cable and device enclosure providing the required protection from cable abrasion and which may provide required sealing of enclosure and cable anchorage

##### G.2.3

##### **cable anchorage**

means to relieve mechanical stress from the cable termination so as to prevent damage to the electrical connection between the device and the cable

#### G.7 Constructional and performance requirements

##### G.7.1 Constructional requirements

##### G.7.1.1 Cable material

The control circuit device shall be provided with flexible cable of appropriate voltage, current and temperature rating and environmental condition.

NOTE The length of cable provided may be specified in the relevant product standard.

### **G.7.1.2 Cable anchorage**

The cable anchorage shall be such that a force being applied to the cable is not transmitted to electrical connections integral to the device.

Movement of the cable into or out of the control circuit device shall not cause damage to the cable connection or internal parts of the device.

### **G.7.1.3 Cable entrance sealing means**

A sealing means shall be provided at the cable entrance to the control circuit device suitable for the degree of protection specified for the device (see Annex C of IEC 60947-1).

NOTE The sealing means may be inherent in the device encapsulation.

### **G.7.2 Performance requirements**

The cable and the cable entrance sealing means shall be capable of withstanding the tests given in G.8.

## **G.8 Tests**

The purpose of these tests is to ensure integrity of the cable anchorage during handling and installation. Once installed, the control circuit device and cable should be fixed relative to each other.

### **G.8.1 Type tests**

The following sequence of four tests shall be performed on a representative sample in the specified order.

#### **G.8.1.1 Pull test**

The cable shall be subjected to a steady pull along the axis of the cable entry, applied to the insulating jacket of the cable for a duration of 1 min.

The pull force shall be 160 N for a cable diameter greater than or equal to 8 mm. The pull force for cable diameters of less than 8 mm shall be of the value (in N) of 20 times the external cable diameter (in mm).

#### **G.8.1.2 Torque test**

The cable shall be subjected to a torque of 0,1·N m or limited to the value giving an angle of torque of 360°. The torque shall be applied clockwise for 1 min and then counter-clockwise for 1 min, to the cable at a distance of 100 mm from the control circuit device entrance.

#### **G.8.1.3 Push test**

The push force shall be applied along the axis of the cable as close as possible to the cable entrance.

The force is increased slowly to 20 N. The force shall be applied for 1 min for each time and with 1 min pause between applications.

After the tests, no visible damage of the cable entrance sealing means and no displacement of the cable shall be observed.



**G.8.1.4 Bend test**

The cable shall be loaded and bent in the following manner:

- a) suspend a 3 kg mass by attaching it to the cable, 1 m from the cable entrance and with the axis of the cable entrance vertical;
- b) tilt the control circuit device 90° to cause a 90° bend in the cable, maintaining that position for 1 min;
- c) tilt the control circuit device 90° in the opposite direction relative to vertical so as to cause an opposite 90° bend in the cable, maintaining the position for a duration of 1 min.

**G.8.2 Results to be obtained**

There shall be no damage to the cable, cable sealing means, cable entrance or the electrical connecting means of the control circuit device. This will be verified by visual examination and verification of compliance with the stated IP designation.

## Annex H (normative)

### Additional requirements for semiconductor switching elements for control circuit devices

#### H.1 General

##### H.1.1 Scope

This annex applies to control circuit devices with semiconductor switching elements for controlling, signalling, interlocking, etc. switchgear and controlgear. These devices shall also comply with the relevant requirements of this standard.

##### H.1.2 Object

The object of this annex is to state additional requirements for semiconductor switching elements which are not contained in this standard.

#### H.2 Definitions

In addition to this standard, the following definitions apply.

##### H.2.1 voltage drop

$U_d$

the voltage measured across the semiconductor switching element when carrying the operational current under specified conditions

##### H.2.2 minimum operational current

$I_m$

the current that is necessary to maintain ON-state conduction of the semiconductor switching element

##### H.2.3 OFF-state current

$I_r$

the current which flows through the load circuit when the switching element is in the OFF-state

#### H.3 Classification

##### H.3.1 Semiconductor switching elements

- 1) Utilization categories (see 4.4 and H.4.2).
- 2) Electrical ratings based on utilization categories (see Annex A).

## H.4 Characteristics

### H.4.1 Rated voltage

#### H.4.1.1 Rated operational voltage ( $U_e$ )

Subclause 4.3.1.1 applies.

#### H.4.1.2 Operational voltage

The operational voltage may be stated as a single value or as a range. When it is stated as a range it shall include all the tolerances of  $U_e$  and shall be designated  $U_B$ . The relationship between  $U_e$  and  $U_B$  is shown in Figure H.1.

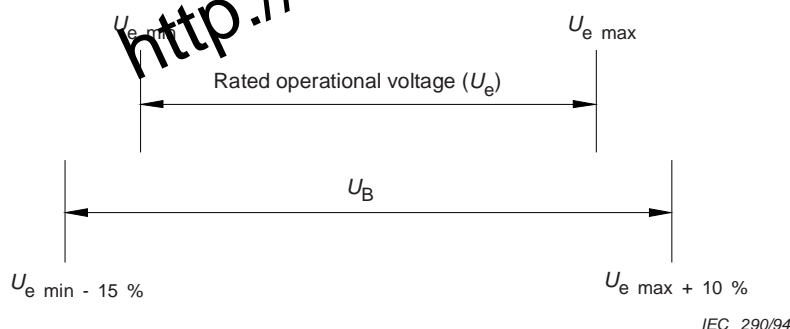

Figure H.1 – Relationship between  $U_e$  and  $U_B$

### H.4.2 Utilization categories

The utilization categories given in Table 1 are considered standard. Any other types of application shall be based on an agreement between manufacturer and user, but information given in the manufacturer's catalogue or tender may constitute such an agreement.

## H.5 Product information

### *Nature of information*

The following information shall be given by the manufacturer: 5.1 applies with the following additions:

#### *Basic rated values and utilization*

- a) Voltage drop (see H.7.1.1)
- b) Minimum operational current (see H.7.1.2)
- c) OFF-state current (see H.7.1.3)
- d) Making and breaking capacities (see H.7.2.1)
- e) Conditional short-circuit current (see H.7.3)
- f) Electromagnetic compatibility, EMC (see H.7.4)

## H.7 Constructional and performance requirements

### H.7.1 Performance requirements

Subclause 7.2 applies with the following additions:

### H.7.1.1 Voltage drop ( $U_d$ )

The voltage drop, measured across the switching element in the conductive mode, shall be stated by the manufacturer and verified according to H.8.2.

### H.7.1.2 Minimum operational current ( $I_m$ )

This shall be stated by the manufacturer and verified according to H.8.2.

**A1** NOTE In Table A.2 the minimum operational currents are specified for the ratings shown. **A1**

### H.7.1.3 OFF-state current ( $I_r$ )

The maximum current ( $I_r$ ) which flows through the load in the OFF-state shall be in accordance with the values given in Tables A.2 and A.3, unless otherwise specified in the relevant product standard. The OFF-state current shall be verified according to H.8.4.

## H.7.2 Ability to make under abnormal and normal conditions

### H.7.2.1 Making and breaking capacities

See 4.3.5.

### H.7.3 Conditional short-circuit current

The switching element shall withstand the stresses resulting from short-circuit currents under the conditions specified in H.8.6.

### H.7.4 Electromagnetic compatibility (EMC)

Subclause 7.3 of IEC 60947-1 applies.

## H.8 Tests

### H.8.1 Type tests

Subclause 8.1.2 applies with the following additions:

- a) Voltage drop (see H.8.2)
- b) OFF-state current (see H.8.4)
- c) Making and breaking capacities (see H.8.5)
- d) Performance under short-circuit current conditions (H.8.6)
- e) Verification of electromagnetic compatibility (see H.8.7)
- f) Impulse voltage withstand test (see 8.3.3.4)

### H.8.2 Voltage drop ( $U_d$ )

The voltage drop is measured across the active output of the switching element in the ON state and carrying the current range of  $I_m$  and  $I_e$  at an ambient temperature of  $23\text{ °C} \pm 5\text{ °C}$  and at the rated frequency. The measurement is performed with the circuit in Figure H.2, with the switch S closed. The loads shall be resistive and  $R_2$  is adjusted to obtain the test current with the supply voltage  $U_e$ .

The measured voltage drop shall not exceed the value specified in H.7.1.1.

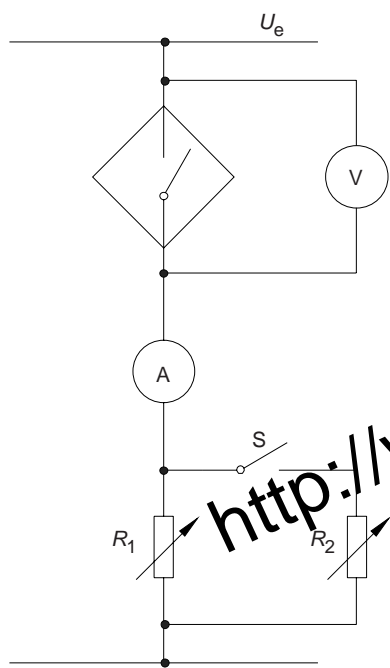

$R_1$  = Resistive load

$R_2$  = Resistive load

V = High impedance voltmeter,  $0,2 \text{ M}\Omega/\text{V}$

A = Ammeter

S = Switch

r.m.s. for a.c.  
average for d.c.

IEC 291/94

**Figure H.2 – Example of test circuit for the verification of voltage drop, minimum operational current and OFF-state current (see H.8.2, H.8.3 and H.8.4)**

### H.8.3 Minimum operational current ( $I_m$ )

The test is performed with the switching element connected to a test circuit shown in Figure H.2. With supply voltage ( $U_e$ ), the switch open and the switching element in ON-state conduction, the resistive load  $R_1$  is adjusted to obtain the current  $I_m$ . The measured value shall be according to H.7.1.2.

### H.8.4 OFF-state current ( $I_r$ )

With the circuit in Figure H.2, and the S switch closed, the load  $R_2$  is adjusted to obtain the rated operational current ( $I_e$ ) when the highest supply voltage ( $U_e$ ) is connected to the circuit. The switching element is then turned off and the OFF-state current is measured. The current shall be according to H.7.1.3.

### H.8.5 Making and breaking capacities

Subclause 8.3.3.5 applies.

### H.8.6 Performance under short-circuit current conditions

#### H.8.6.1 Test circuit and test procedure

A new switching element shall be mounted as in service, in free air, and connected to the test circuit using a 2 m total length cable suitable for the operational current of the switching element (see Figure H.3).

The short-circuit protective device (SCPD) shall be of the type and rating stated by the manufacturer. This SCPD shall be omitted if the switching element is integrally protected against short circuit.

The loads,  $R$  and  $L$  are so selected that the current flowing through the switching element is equal to its rated operational current at the rated operational voltage ( $U_e$ ) and at the power factor or  $T_{0,95}$  time constant stated in Table 5 or in Table H.3. The supply  $S$  shall be adjusted to a prospective short-circuit current of 1 000 A, unless otherwise specified in the product standard, at the rated operational voltage ( $U_e$ ). The supply circuit shall have an inductor reactor connected in series with resistors to provide a power factor of 0,5 to 0,7. No damping load shall be added parallel with the reactors. The open circuit voltage shall be 1,1 times the maximum rated operational voltage of the switching element.

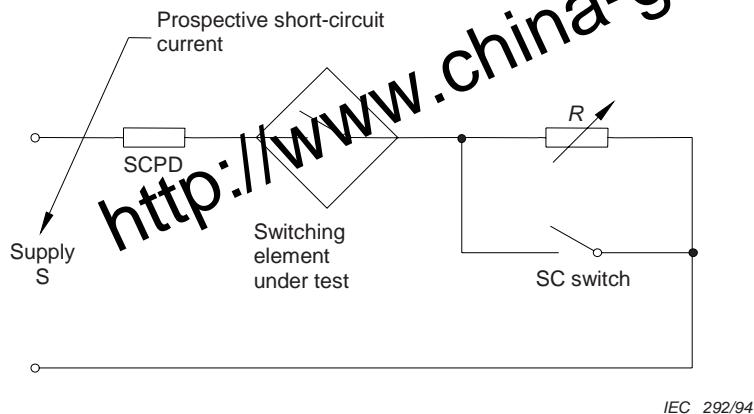

Figure H.3 – Short-circuit testing (see H.8.6.1)

The test shall be performed three times by randomly closing the "SC" switch. The test current is maintained until the SCPD operates or in the case of self-protecting elements, for 30 min. After each test the SCPD shall be replaced or reset. The interval between each of the three tests shall be not less than 3 min. The actual time between tests shall be stated in the test report.

#### H.8.6.2 Condition of the switching element after the test

Subclause 8.3.4.4 applies.

#### H.8.7 Verification of electromagnetic compatibility

##### H.8.7.1 General

Emission and immunity tests are type tests and shall be carried out under the following common conditions.

The switching element is mounted in free air connected to a load corresponding to the rated operational current ( $I_e$ ) and is supplied with its rated operational voltage ( $U_e$ ), or the maximum voltage of its voltage range.

The connecting leads shall be 2 m in length.

The tests shall be performed

- with the switching element in the ON-state,
- with the switching element in the OFF-state.

## **H.8.7.2 Immunity**

### **H.8.7.2.1 General**

Performance criteria are based on the acceptance criteria in Table 24 of IEC 60947-1.

Performance criterion A: During the tests, the output state of the switching element shall not change.

Performance criterion B: During the tests, the output state of the switching element shall not change for more than 1 ms for d.c. devices or one half wave of supply frequency for a.c. devices.

Performance criterion C: Temporary degradation or loss of performance which is self recoverable or requires system reset.

<http://www.china-gauges.com/>

 Table H.1 – Immunity tests

Type of test	Test level required		Acceptance criteria
Electrostatic discharge immunity test IEC 61000-4-2	8 kV / air discharge or 4 kV / contact discharge		B
Radiated radio-frequency electromagnetic field immunity test (80 MHz to 1 GHz and 1,4 GHz to 2 GHz) IEC 61000-4-3	10 V/m		A
Electrical fast transient/burst immunity test IEC 61000-4-4	2 kV / 5 kHz on power ports <sup>a</sup> 1 kV / 5 kHz on signal ports <sup>b</sup>		B
Surge immunity test (1,2/50 $\mu$ s – 8/20 $\mu$ s) IEC 61000-4-5 <sup>c</sup>	2 kV (line to earth) 1 kV (line to line)		B
Conducted disturbances induced by radio-frequency fields immunity test (150 kHz to 80 MHz) IEC 61000-4-6	10 V		A
Power frequency magnetic field immunity test <sup>d</sup> IEC 61000-4-8	30 A/m		A
Voltage dips immunity test IEC 61000-4-11	Class 2 <sup>e, f</sup> 0 % during 0,5 cycle	Class 3 <sup>e, f</sup> 0 % during 0,5 cycle	B
	Class 2 <sup>e, f, g</sup> 0 % during 1 cycle 70 % during 25/30 cycles	Class 3 <sup>e, f, g</sup> 0 % during 1 cycle 40 % during 10/12 cycles 70 % during 25/30 cycles 80 % during 250/300 cycles	C
Voltage interruptions immunity test IEC 61000-4-11	Class 2 <sup>e, f, g</sup> 0 % during 250/300 cycles	Class 3 <sup>e, f, g</sup> 0 % during 250/300 cycles	C
Immunity to harmonics in the supply IEC 61000-4-13	No requirements <sup>h</sup>		
<p><sup>a</sup> Power port: the point at which a conductor or cable carrying the primary electrical power needed for the operation of the switching element or associated equipment is connected.</p> <p><sup>b</sup> Signal port: the point at which a conductor or cable carrying information for transferring data or signals is connected to the switching element.</p> <p><sup>c</sup> Not applicable for ports with a rated voltage of 24 V or less.</p> <p><sup>d</sup> Applicable only to equipment containing devices susceptible to power frequency magnetic fields.</p> <p><sup>e</sup> Class 2 applies to points of common coupling and in-plant points of common coupling in the industrial environment in general. Class 3 applies to in-plant couplings in industrial environment only. This class should be considered when a major part of the load is fed through converters; welding machines are present; large motors are frequently started or loads vary rapidly. The manufacturer shall state the applicable class.</p> <p><sup>f</sup> The given percentage means percentage of the rated operational voltage, e.g. 0 % means 0 V.</p> <p><sup>g</sup> The value before the solidus (/) is for 50 Hz and the value behind is for 60 Hz tests.</p> <p><sup>h</sup> Requirements are under study for the future.</p>			



#### H.8.7.2.2 Electrostatic discharges

The test shall be performed according to IEC 61000-4-2 and Table H.1.

#### H.8.7.2.3 Radiated radio-frequency electromagnetic fields

The test shall be performed according to IEC 61000-4-3 and Table H.1.

If the worst case direction is known, then the test need only be performed in that direction. Otherwise, the electromagnetic field shall be faced to the device under test in three mutually perpendicular directions.

#### H.8.7.2.4 Electrical fast transients/bursts

The test shall be performed according to IEC 61000-4-4 and Table H.1, with the connecting leads of the device placed in the capacitive coupling clamp.

NOTE The capacitive coupling is the preferred test method because it simulates the disturbances present during normal application as a result of parallel wires.

#### H.8.7.2.5 Surges

The test shall be performed according to IEC 61000-4-5 and Table H.1, with the following additional requirements in order to simplify the test procedure without impairing the validity of the verification of the EMC requirements:

- the switching element is powered during the test.
- the impulse test shall be applied:
  - a) between terminals intended to be connected to the power supply;
  - b) between each output terminal and each terminal intended to be connected to the power supply.
- Three positive and three negative impulses shall be applied between each two points at intervals of not less than 5 s.

#### H.8.7.2.6 Conducted disturbances induced by radio-frequency fields

The test shall be performed according to IEC 61000-4-6 and Table H.1.

#### H.8.7.2.7 Power-frequency magnetic fields

The test shall be performed according to IEC 61000-4-8 and Table H.1.

Applicable only to equipment containing devices susceptible to power-frequency magnetic fields.

#### H.8.7.2.8 Voltage dips and interruptions

The test shall be performed according to IEC 61000-4-11 and Table H.1.

Applicable only to a.c. switching elements.

#### H.8.7.3 Emission

The test shall be performed under worst case conditions according to CISPR 11 Group 1, Class A, and 7.3.3.2 of IEC 60947-1.

These limits are given for switching elements exclusively intended for use in industrial environment A. When they can be used in domestic environment B, the following notice shall be included in the instructions for use:

NOTICE

This is a Class A product. In a domestic environment this product may cause radio interference in which case the user may be required to take appropriate measures.

<http://www.china-gauges.com/>

## Annex J (normative)

### Special requirements for indicator lights and indicating towers

#### J.1 General

##### J.1.1 Scope

This annex applies to indicator lights and indicating towers, which shall also comply with the relevant requirements of this standard.

##### J.1.2 Object

This annex gives additional requirements applicable to indicator lights, together with definitions and terms useful for stating the required characteristics of design and performance.

#### J.2 Definitions

The following additional definitions are applicable:

##### J.2.1

###### **indicator light**

light signal giving information either by lighting or extinguishing

##### J.2.2

###### **lens of an indicator light**

visible part, removable or not, constituting the surface intentionally made transparent or translucent

##### J.2.3

###### **bezel**

holder of a lens

##### J.2.4

###### **indicator light with a built-in voltage-reducing device**

indicator light, the body of which contains a device (transformer, resistor, etc.) intended to supply, at the terminals of a lamp, a voltage different from the rated operational voltage of the light

##### J.2.5

###### **indicating tower**

assembly including one or more signalling units giving information by visible or audible signals

NOTE Other elements, e.g. network interface elements may be added.

### J.3 Classification

Indicator lights may be classified by:

- the rated electrical power;
  - the colour;
  - the fixing hole diameter;
  - the means of connection;
  - the nature of the current applied and its frequency, if any (for example lights with built-in transformers);
  - the type of lamp socket.
- Ⓐ) – Nature of light source (for example: filament lamp, LED) Ⓐ)

### J.4 Characteristics

#### J.4.1 Rated operational voltage of an indicator light

A value of voltage, assigned by the manufacturer which determines the application of the indicator light.

#### J.4.2 Rated thermal power of an indicator light

The maximum lamp power which an indicator light is designed to tolerate under conditions specified for the temperature-rise test.

NOTE As the power of the light has an effect on the temperature rise, it may be necessary to limit the power according to the mounting conditions; the manufacturer of the indicator light may assign two values of rated power (see J.8.3.3.3):

- the rated power of the light for mounting on a steel plate;
- the rated power of the light for mounting in an insulating enclosure.

#### J.4.3 Rated values of the lamp

Rated value of the lamp(s) indicated by the manufacturer and with which the indicator light operates without attaining temperatures likely to damage its parts.

NOTE 1 Rated power and voltage may be indicated by a type designation.

NOTE 2 It is assumed that a lamp does not dissipate a power higher than its rated power at its rated voltage.

### J.5 Product information

The applicable requirements are:

Items a) and b) of 5.1;

c) the following markings shall appear on the indicator light:

- 1) rated voltage of the indicator light;
- 2) rated voltage of the lamp (if different from the rated voltage of the indicator light).
- 3) rated power of the lamp or its type designation, or rated current for a LED.

### J.6 Normal service, mounting and transport conditions

There are no supplementary requirements.

The following mounting dimensions for the indicating tower socket are recommended:

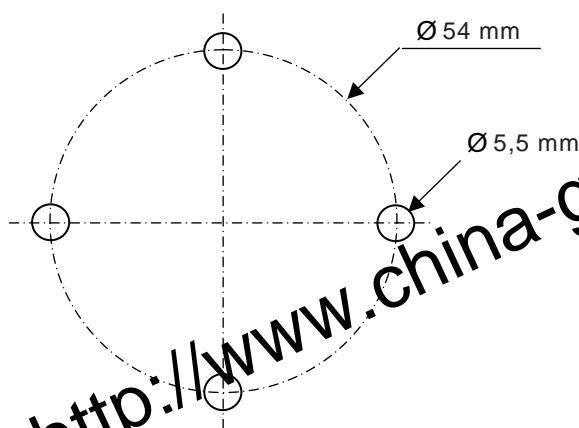

IEC 2647/03

## J.7 Constructional and performance requirements

Clause 7 applies with the following additions:

### J.7.1.12 Indicator lights with built-in transformers

The transformer shall have separate windings.

It is assumed that this condition is fulfilled if the indicator light passes the test described in 8.3.3.4.1.

**A1** Subclause deleted **A1**

### J.7.2.1.6 Limits of operation

The limiting value of the supply voltage at the terminals of the indicator light shall be 1,1 times the rated operational voltage. This requirement is verified only for indicator lights with built-in transformer according to J.8.3.4.

### J.7.2.5.1 Short-circuit withstandability of built-in transformer

The transformer shall be able to withstand permanently the short circuit of its secondary winding. It is assumed that this condition is fulfilled if the indicator light passes the test described in J.8.3.3.3.

<sup>1)</sup> IEC 60204-1, *Safety of machinery – Electrical equipment of machines – Part 1: General requirements*

## J.8 Tests

### J.8.3 Tests for indicator lights and indicating towers

The tests are type tests. No additional test (routine test or special test) is prescribed in this annex.

Each of the tests in J.8.3.3.3, J.8.3.3.4, J.8.3.4 and J.8.4 shall be made on new apparatus mounted in accordance with the test instructions.

#### J.8.3.3.3 Temperature-rise tests

- a) If the indicator light has the same rated thermal power (see J.4.2) regardless of mounting conditions, a single test is made in an insulated enclosure.
- b) If the rated thermal power (see J.4.2) is dependent on the mounting conditions, two tests are made:
  - on a steel plate, and
  - in an insulated enclosure.
- c) Mounting on a steel plate

Five indicator lights fitted with green lenses are fixed in accordance with the following diagram on a steel plate 2 mm thick, painted mat black:

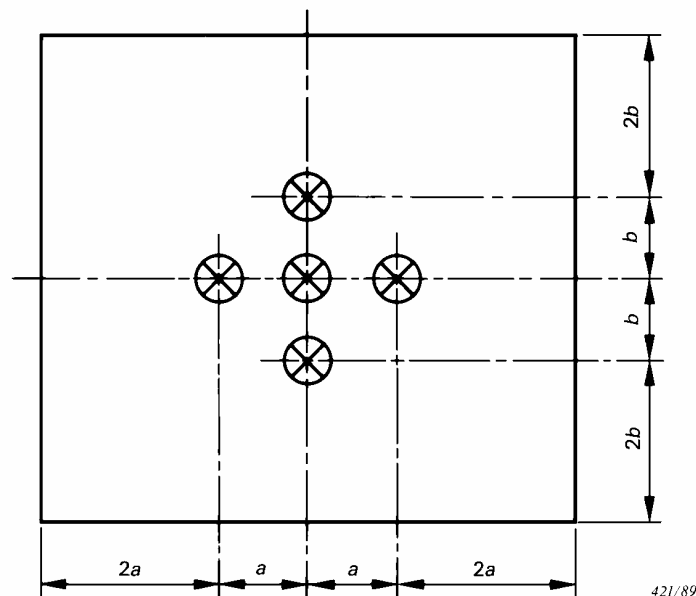

421/89

Dimensions  $a$  and  $b$  are:

- 1) for indicator lights forming an integral part of a push-button range: in accordance with 6.3.1.3;
- 2) for other indicator lights: as stated by the manufacturer, but the values used shall be recorded in the test report.

The indicator lights are fitted with lamps as stated by the manufacturer and, if any, with built-in devices such as transformers, resistances, etc. The conductor sizes shall be as specified in 8.3.3.3.

The plate is located vertically on a table and the indicator lights are supplied at their rated voltage. The duration of the test shall be such that a steady-state temperature is reached.

## d) Mounting in an insulating enclosure

The test described in item c) is carried out again with the indicator lights mounted into an enclosure of insulating material, such as bakelite-coated paper 2 mm thick, the front face of which has the same dimensions as the steel plate and the depth of which is 110 mm. The indicator lights are fitted with lamps and mounted as stated by the manufacturer for this type of use; they are supplied at their rated operational voltage.

The duration of the test shall be such that a steady-state temperature is reached.

## e) Results to be obtained

At the end of each of the tests described in items c) and d) the temperatures are measured:

- on the body of the indicator light;
- on the terminals;
- on the accessible part of the lens.

## f) For indicating towers, an arrangement of five visual signalling units shall be mounted in a vertical position. The upper three signalling units, or the maximum number stated by the manufacturer if greater than three, shall be equipped with the maximum power lamp of signalling units as stated by the manufacturer and powered at the rated voltage. After the steady state temperature is reached, the temperature shall be measured on top of the tower and on the lens of the centre element of the complete tower.

None of the corresponding temperature-rises shall exceed the limits referred to in 7.2.2 of IEC 60947-1.

**J.8.3.3.4 Dielectric tests**

8.3.3.4 applies.

**J.8.3.3.4.3 Indicator lights with built-in transformers**

Two additional dielectric tests shall be made, the duration of each being 1 min:

- between the primary and secondary windings of the transformer with the test voltage value specified in 8.3.3.4;
- between the secondary windings of the transformer and the frame of the indicator light with a test voltage value of 1 000 V.

**J.8.3.4 Short-circuit test (on built-in transformers, if any)**

The test shall be made under the following conditions:

- primary voltage:  $1,1 \cdot U_e$ ;
- ambient air temperature:  $20 \text{ °C} \pm 5 \text{ °C}$ ;
- duration of the test: 1 h.

The transformer shall be short-circuited by a conductor of negligible impedance.

After the test and after cooling to ambient temperature, the transformer shall withstand the dielectric test defined in J.8.3.3.4.3.

## **J.8.4 Shock and vibration**

### **J.8.4.1 Direct mounting**

#### **J.8.4.1.1 General**

An indicating tower with five signalling units shall be mounted as stated by the manufacturer without extension poles and the upper three units powered at the rated voltage.

The tests shall be performed as follows.

#### **J.8.4.1.2 Shock**

In accordance with IEC 60068-2-27 with the following conditions.

Six shocks applied in every direction along three mutually perpendicular axes (a total of 36 shocks):

- pulse shape: half-sine;
- peak acceleration:  $15 g_n$ ;
- duration of the pulse: 11 ms.

#### **J.8.4.1.3 Vibration**

In accordance with IEC 60068-2-6 with the following conditions, along three mutually perpendicular axes:

- frequency range: 10 Hz to 55 Hz;
- amplitude: 0,5 mm;
- sweep cycle duration: 5 min;
- duration at resonant frequency or at 55 Hz: 30 min in each of the three axes (90 min in total).

### **J.8.4.2 Indirect support mounting**

If the product literature includes other allowable mounting conditions (e.g. pole mounting), the manufacturer shall state the severity level for shock and vibration tests at which the requirements of J.8.4.3 are met.

### **J.8.4.3 Results to be obtained**

After the tests, no visible damage shall be observed and the signalling shall not be impaired.

## **J.8.5 Degree of protection for indicating towers**

If the manufacturer declares a degree of protection, the test shall be conducted according to Annex C of IEC 60947-1 with all removable parts equipped as in normal service.



## Annex K (normative)

### Special requirements for control switches with direct opening action

#### K.1 General

##### K.1.1 Scope

This annex is applicable to control switches with direct opening action.

All control switches with direct opening action shall also comply with the relevant requirements of the standard and, where applicable, to those given in Annexes F, G, H and/or J.

##### K.1.2 Object

This annex gives additional requirements applicable to control switches with direct opening action, together with definitions and terms useful for stating the required characteristics of design and performance.

#### K.2 Definitions

The following additional definitions apply:

##### K.2.1

###### **control switch with direct opening action**

control switch having one or more break-contact elements coupled to the switch actuator via non-resilient members so that full contact opening of the break-contact element(s) is obtained when the actuator is moved through the direct opening travel by applying the force stated by the manufacturer

##### K.2.2

###### **direct opening action (of a contact element)**

achievement of contact separation as the direct result of a specified movement of the switch actuator through non-resilient members (for example not dependent upon springs)

##### K.2.3

###### **direct opening travel**

travel from the beginning of actuation of the actuator and the position when the direct opening action of the opening contacts is completed

##### K.2.4

###### **direct opening force (or moment)**

actuation force, or actuating moment for a rotary control switch, applied to the actuator for the direct opening action

### K.3 Classification

There are two types of control switches with direct opening action:

*Type 1:* Having one contact element only, this contact element is a direct opening break-contact element.

*Type 2:* Having one or more break-contact elements, and possibly, one or more make-contact elements and/or one or more change-over contact elements. All break-contact elements including the break part of change-over contact elements shall be direct opening break-contact elements.

### K.4 Characteristics

The following additional characteristics apply:

#### K.4.3.1.2 Rated insulation voltage

$\text{A1}$  The minimum value of the rated insulation voltage of the contact elements shall be 250 V.  $\text{A1}$

#### K.4.3.2.1 Conventional free air thermal current

$\text{A1}$  The minimum value of the conventional free air thermal current of the contact elements shall be 2,5 A.  $\text{A1}$

#### K.4.4 Utilization categories for switching elements

The utilization categories shall be AC-15 or DC-13.

NOTE Additional utilization categories AC-14 and DC-14 are permitted.

### K.5 Product information

Clause 5 is applicable with the following additions:

#### K.5.2 Marking

##### K.5.2.7 Direct opening action

Every contact element with direct opening action shall be indelibly and legibly marked on the outside by the symbol:

  $\text{A1}$  IEC 60617-S00226 (2001-07)  $\text{A1}$

##### K.5.2.8 Electrical separation for change-over contact elements

Change-over contact elements with four terminals shall be indelibly and legibly marked with the relevant form Za or Zb as stated in Figure 4.

## K.5.4 Additional information

### K.5.4.1 Actuator travel and operating force

The manufacturer shall state the following:

- a) the minimum direct opening travel;
- b) the minimum force required to achieve direct opening action of all break contacts;
- c) the maximum travel including travel beyond the minimum travel position (i.e. including overtravel);
- d) for limit switches only the maximum speed of actuation;
- e) for limit switches only the maximum frequency of actuation.

These statements shall appear in the marking or on the circuit diagram or other documents published by the manufacturer.

NOTE 1 See also K.7.1.5.3.

NOTE 2 Type 2 control switches may open with less travel than the direct opening travel stated by the manufacturer.

### K.5.4.2 Short-circuit protection

The type of short-circuit protective device shall be stated either as marking on the switch or in the installation instructions.

## K.6 Normal service, mounting and transport conditions

Clause 6 applies, with the following additions:

### K.6.1.1 Ambient air temperature

Subclause 6.1.1 of IEC 60947-1 applies, except for position switches with direct opening action, for which the upper and lower limits of temperature are respectively +70 °C and -25 °C, and the average temperature, measured over a period of 24 h, does not exceed +35 °C.

NOTE The choice of the connecting conductors may, if necessary, be subject to agreement between manufacturer and user (see note 1 of Table 2 of 60947-1).

## K.7 Constructional and performance requirements

Clause 7 applies with the following additions:

### K.7.1.4.3.1 Robustness of the actuating system

In order to have sufficient robustness, the actuating system shall pass the test described in K.8.3.7.

### K.7.1.4.3.2 Directness of opening action

A control switch with direct opening action shall pass the tests described in K.8.3.4, K.8.3.5 (in the case of a position switch with a direct opening action), and K.8.3.7 without any deformation that would reduce the impulse voltage withstand across the contact gap.

#### **K.7.1.4.5 Automatic opening of cable operated control switches**

Cable operated control switches with direct opening action shall return automatically to the open position in case of failure of the cable or its anchorage.

#### **K.7.1.4.6 Conditions for direct opening action** (see 2.4.10 of IEC 60947-1)

For parts of the travel that separates the contacts, there shall be a positive drive with no resilient member (for example springs) between the moving contacts and the point of the actuator to which the actuating force is applied.

##### **K.7.1.4.6.1 Contact element types**

Control switches with direct opening action may be provided with snap action or dependent action contact elements.

The break-contact elements shall be electrically separated from each other and from the operating make-contact elements.

When the control switch has form C or form Za change-over contact elements (see Figures 4 c) and 4 d)), only one contact element (make or break) shall be used. In the case of form Zb change-over contact elements, both contacts may be used.

##### **K.7.1.5.3 Actuator travel indication**

In order to facilitate the setting up of the switch actuator in relation to the external operating means, for example a cam, the switch may include means for indicating the minimum travel of the actuator required to ensure direct opening action, for example by the provision of a mark on the actuator plunger (see note 1, item a) of K.5.4.1).

## **K.8 Tests**

In addition to clause 8, and Annex C, the following applies:

### **K.8.3.1 Test sequences**

Subclause 8.3.1 applies with the following additions:

- Test sequence VII (sample No. 7) – Mechanical operation of position switches with direct opening action.
  - Test No. 1 – Mechanical operation at limits of temperature (see K.8.3.5).
  - Test No. 2 – Verification of direct opening action (see K.8.3.6).
- Test sequence VIII (sample No. 8)
- Verification of robustness of the actuating system (see K.8.3.7).

### **K.8.3.4 Performance under conditional short-circuit current**

Subclause 8.3.4 applies with the following additions:

**K.8.3.4.2.1 Verification of conditional short-circuit current**

- A1** The test shall be made as stated in 8.3.4.2, except that the current is made by a direct opening contact element and not by the additional switching device and the test is made on the device by making the current three times by the same contact element in a single phase circuit. **A1**

For type 2 control switches, the contact element shall be chosen at random.

**K.8.3.4.4.1 Operation ability after the test**

- A1** After each test, the opening contact element shall open by the application of the force stated by the manufacturer through the direct opening travel (see items a) and b) of K.5.4.1). **A1**

The open position of the contact element shall be verified by the application of an impulse test voltage of 2 500 V across the contact gap.

**K.8.3.5 Verification of mechanical operation of position switches at limits of temperature**

This test applies only to position switches with direct opening action. The position switch shall be conditioned at +70 °C for 8 h.

At the end of the conditioning period and at the same temperature, the contacts shall be loaded with the maximum rated operational current for 10 min. The contacts shall then be operated 10 times by the application of the force stated by the manufacturer according to item b) of K.5.4.1.

The test shall be repeated after conditioning at –25 °C but without application of the current.

After completion of this test, the open position of the contacts shall be verified according to K.8.3.6.

**K.8.3.6 Verification of direct opening action**

When the position switch is in the position corresponding to the direct opening travel stated in item a) of K.5.4.1, the contact gap shall withstand an impulse voltage of 2 500 V.

For position switches suitable for isolation, the value of the impulse withstand voltage shall be in accordance with Table 14 of IEC 60947-1 corresponding to the rated impulse withstand voltage  $U_{imp}$  declared by the manufacturer.

**K.8.3.7 Verification of robustness of the actuating system**

The closed break contact(s) shall be loaded with a force  $F_1$  of 10 N (see Figure K.1). A force (moment)  $F_2$ , higher than  $F_1$ , stated by the manufacturer, shall be applied to the actuator through the direct opening travel.

After this test, the actuating system and/or contacts shall remain functional and shall withstand an impulse test voltage in accordance with K.8.3.6.

For position switches suitable for isolation, the value of the impulse withstand voltage shall be in accordance with Table 14 of IEC 60947-1 corresponding to the rated impulse withstand voltage  $U_{imp}$  declared by the manufacturer.

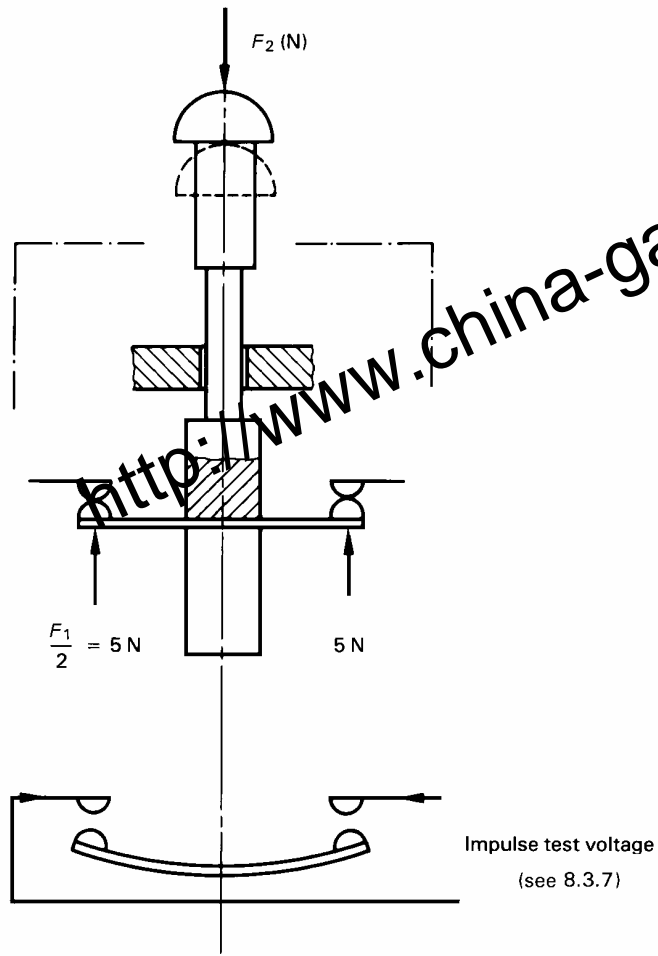

IEC 914/97

NOTE -  $F_1$  = Required opening force = 10 N.  
 $F_2$  = Force (moment) stated by the manufacturer.

Figure K.1 – Verification of robustness of the actuating system

## Annex L (normative)

### Special requirements for mechanically linked contact elements

#### L.1 General

##### L.1.1 Scope

This annex applies to mechanically linked auxiliary contact elements included in control circuit devices where actuating force is provided internally, such as contactor-relays.

Linkage between the auxiliary and main contacts is not covered by this annex.

NOTE 1 A typical application of mechanically linked contact elements is e.g. self-monitoring in machine control circuits.

NOTE 2 Mechanically linked contact elements have previously been referred to as forced contacts, positively activated contacts, or linked contacts, or, in French: "contacts forcés" or in German: "Zwangsgeführte Kontakte".

NOTE 3 Control circuit devices actuated externally (e.g. push-button or limit-switches) do not have an actuating force limited to a maximum value (see L.8.4 a) 2)), so they cannot have mechanically linked contact elements. For such devices, safety applications generally use contacts with "direct opening action" (see Annex K).

##### L.1.2 Object

This annex provides additional specifications (definition, requirements and tests) which shall be used for stating the required design characteristics, marking and performance of mechanically linked contact elements.

#### L.2 Definition

The following additional definition applies:

##### L.2.1

###### **mechanically linked contact elements**

combination of  $n$  Make contact element(s) and  $m$  Break contact element(s) designed in such a way that they cannot be in closed position simultaneously under conditions defined in L.8.4

NOTE 1 One control circuit device may have more than one group of mechanically linked contact elements.

NOTE 2 See also L.7.1.9.

#### L.3 Classification

Clause 3 applies.

#### L.4 Characteristics

All mechanically linked contact elements shall also comply with the relevant requirements given in this standard.

## L.5 Product information

Clause 5 applies with the following addition:

### L.5.2.7 Mechanically linked contact elements identification and marking

Mechanically linked contact elements shall be clearly identified:

- on the control circuit device itself;
- or in the manufacturer's documentation;
- or both.

The mechanical linkage shall be identified in circuit diagrams by a double parallel line connecting a filled circle on each of the mechanically linked contact symbols. An example is given in Figure L.1.

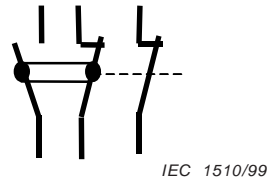

**Figure L.1 – Example of representation of NO and NC contacts which are mechanically linked and NC non-linked contact**

If devices containing some or all mechanically linked contacts are marked, the symbol shown in Figure L.2 shall be used.

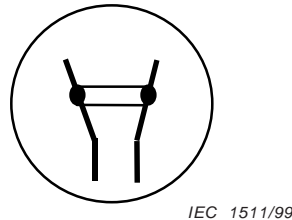

**Figure L.2 – Symbol for device containing mechanically linked contacts**

## L.6 Normal service, mounting and transport conditions

There are no supplementary requirements.

## L.7 Constructional and performance requirements

Clause 7 applies with the following addition:

### L.7.1.9 Requirements for mechanically linked contact elements

While any of the  $n$  Make contact element(s) is closed, none of the  $m$  Break contact element(s) shall be closed.

While any of the  $m$  Break contact element(s) is closed, none of the  $n$  Make contact element(s) shall be closed.



## L.8 Tests

Clause 8 applies with the following addition:

### L.8.4 Special test for mechanically linked contact elements

This special test shall be carried out on a sample of  $(m + n)$  products, where  $m$  is the number of break contact element(s) and  $n$  is the number of make contact element(s).

A different sample is used for each test.

The tests shall be carried out on products in new and clean condition. The test procedure shall be as follows:

a) Test of NC contact:

- 1) the NC contact element shall be maintained in the closed position e.g. by welding or gluing each point of contact (e.g. for double breaking contact, welding is done at the two contacts points). The thickness of welding or gluing shall be such that the distance between contacts is not modified by more than 0,02 mm;
- 2) an actuating force shall be applied by energising the operating coil at 110 % of its rated voltage;
- 3) while applying the force, an impulse test voltage of 2,5 kV (1,2/50  $\mu$ s at sea level; correction should be made according to Table 12 of IEC 60947-1) shall be applied across every NO contact. There shall be no disruptive discharge.

**A1** NOTE 1 This test ensures a minimum gap of 0,6 mm in accordance with Table 13 of IEC 60947-1. **A1**

b) Test of NO contact:

- 1) an actuating force shall be applied by energising the operating coil at its rated voltage;
- 2) the NO contact element shall be maintained in the closed position e.g. by welding or gluing each point of contact (e.g. for double breaking contact, welding is done at the two contacts points). The thickness of welding or gluing shall be such that the distance between contacts is not modified by more than 0,02 mm;
- 3) an actuating force shall be applied by de-energising the operating coil;
- 4) with the operating coil de-energised, an impulse test voltage of 2,5 kV (1,2/50  $\mu$ s at sea level; correction should be made according to Table 12 of IEC 60947-1) shall be applied across every NC contact. There shall be no disruptive discharge.

**A1** NOTE 2 This test ensures a minimum gap of 0,6 mm in accordance with Table 13 of IEC 60947-1. **A1**

---

**Annex M**  
(normative)

**Terminal marking, distinctive number and distinctive letter for control circuit devices**

**M.1 Scope**

This annex applies to control switches and contactors, relays irrespective of their construction, having terminal marking.

The use of this annex is required where terminal marking is a requirement in this standard, or is usual practice.

**M.2 Terminal marking rule**

**M.2.1 General**

Terminal marking in accordance with this annex is based, in principle, on a two-digit number.

**M.2.2 Function digit**

Subclause L.3.2.1 of IEC 60947-1 applies.

**M.2.3 Sequence digit**

The tens digit is a continuous sequence number beginning with 1 (except for control switches designated 01 and contactor relays designated 01E), independent of the contact function.

Terminals belonging to the same contact are marked with the same sequence digit.

For contactor relays having 10 contact elements, the sequence digit 0 is used instead of 10.

The sequence digit may be omitted from the terminal marking only if additional information provided by the manufacturer or the user clearly gives such digit. **A1**

**A1** EXAMPLE For control switches

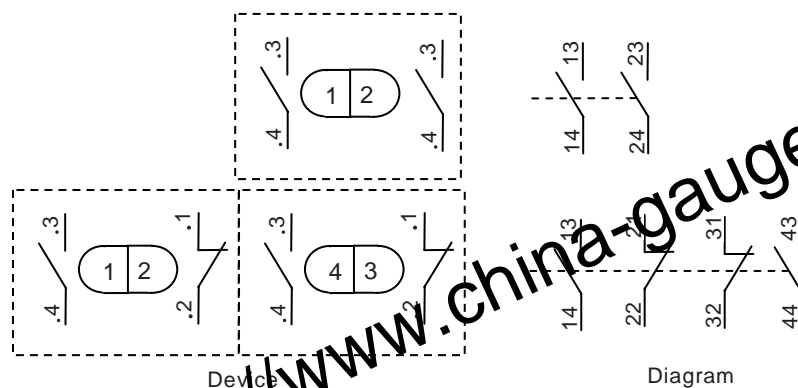

NOTE The dots before the terminal number shown in these examples are used merely to show the digit relationship, and do not need to be used in practice.

### M.2.4 Numbering method

The contact terminals shall be numbered sequentially from left to right on the device; for devices with tiers of terminals, the numbering shall begin with the tier nearest to the mounting level.

EXAMPLE Contact numbering methods on contactor relays of various constructional types, but with the same distinctive number 62 E

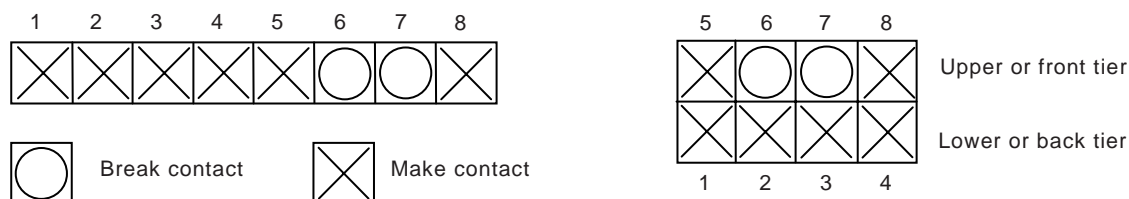

The prescribed numbering method does not allow blank contact cells inside a contact series.

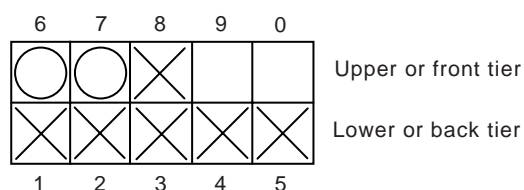

### M.3 Distinctive number and distinctive letter

#### M.3.1 General

The quantity and type of the contact elements of a control switch according to this annex are indicated by a distinctive number. Contacts of contactor relays are indicated by a distinctive number followed by a distinctive letter.

#### M.3.2 Distinctive number

The first digit of the distinctive number gives the quantity of make contact elements and the second digit the quantity of break contact elements. The third digit, if any, shall give the quantity of change-over contact elements in control switches. **A1**

**M.3.3 Distinctive letter**

The distinctive letter indicates the location of the contact elements of a contactor relay in relation to each other and their terminal marking.

Clause M.5 defines the arrangement of contactor relays indicated by the distinctive letter E.

Clause M.6 gives information on permissible deviations, indicated by the distinctive letters X, Y or Z.

For new designs, the arrangement indicated by the distinctive letter E is preferred.

**M.4 Terminal numbering sequence**

For control switches having the same distinctive number, the terminal marking is specified in Table M.1.

The position of the contact elements of the control switch need not correspond to that shown on diagrams of Table M.1.

**Table M.1 – Diagrams of control switches**

Distinctive number	Contact elements	Distinctive number	Contact elements	Distinctive number	Contact elements	Distinctive number	Contact elements	Distinctive number	Contact elements
10								01	
20		11						02	
30		21		12				03	
40		31		22		13		04	
001									
002									

**M.5 Contactor relays designated by the distinctive letter E**

For contactor relays having the same distinctive number and the distinctive letter E, independently of their construction, the sequence of the contact elements within the device is specified in accordance with the diagrams of Table M.2. **A1**

Ⓐ) As a result of this the sequence number becomes a location number and allows a given contact element terminal of a contactor relay in the equipment to be quickly found solely by counting the contacts. Ⓐ)

<http://www.china-gauges.com/>

Table M.2 – Diagrams of contactor relays designated by the distinctive letter E

Coil	Contact elements	Contact elements	Contact elements	Contact elements	Contact elements	Contact elements	Contact elements	Contact elements	Contact elements
10E									
20E									
30E									
40E									
50E									
60E									
80E									
100E									

<http://www.china-gauges.com/>

**A1** M.6 Contactor relays designated by distinctive letters X, Y or Z

**M.6.1 Contactor relays designated by the distinctive letter Z**

If the location of the contact elements within the device (but not the terminal marking) differs from the provisions of Clause M.5, the device shall be designated by the distinctive letter Z instead of the distinctive letter E.

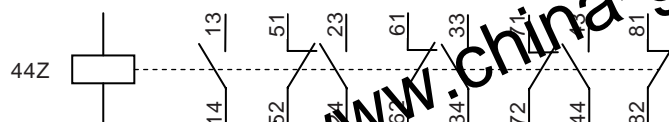

**M.6.2 Contactor relays designated by the distinctive letter X**

If the location of the contact elements within the device and the terminal marking both differ from the requirements of Clause M.5, the device shall be designated by the distinctive letter X instead of the distinctive letter E.

Such a device shall still comply with the requirements of Clauses M.2 and M.3.

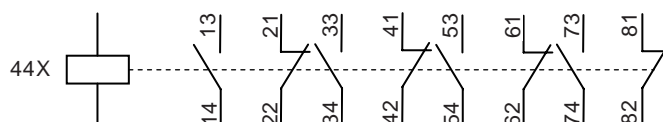

**M.6.3 Contactor relays designated by the distinctive letter Y**

Devices consisting of combinations of contact elements and terminal marking in accordance with Table M.3 shall be designated by the distinctive letter Y instead of the distinctive letter E.

**Table M.3 – Diagrams of contactor relays designated by the distinctive letter Y**

42Y	<p>(31E + 11)</p>	33Y	<p>(22E + 11)</p>	53Y	<p>(31E + 22)</p>	44Y	<p>(22E + 22)</p>
-----	-------------------	-----	-------------------	-----	-------------------	-----	-------------------

 **Bibliography**

IEC 61810 (all parts), *Electromechanical elementary relays*

\_\_\_\_\_



<http://www.china-gauges.com/>



## Annex ZA (normative)

### Normative references to international publications with their corresponding European publications

The following referenced documents are indispensable for the application of this document. For dated references, only the edition cited applies. For undated references, the latest edition of the referenced document (including any amendments) applies.

NOTE Where an international publication has been modified by common modifications, indicated by (mod), the relevant EN/HD applies.

Publication	Year	Title	EN/HD	Year
IEC 60050-441 A1	1984 2000	International Electrotechnical Vocabulary Chapter 441: Switchgear, controlgear and fuses	-	-
IEC 60050-446	1983	International Electrotechnical Vocabulary (IEV) - Chapter 446: Electrical relays	-	-
IEC 60068-2-6 + corr. March	1995 1995	Environmental testing - Part 2: Tests - Test Fc: Vibration (sinusoidal)	EN 60068-2-6	1995 <sup>1)</sup>
IEC 60068-2-14 + A1	1984 1986	Environmental testing - Part 2: Tests - Test N: Change of temperature	EN 60068-2-14	1999
IEC 60068-2-27	1987	Basic environmental testing procedures - Part 2: Tests - Test Ea and guidance: Shock	EN 60068-2-27	1993 <sup>2)</sup>
IEC 60068-2-30	2005	Environmental testing - Part 2-30: Tests - Test Db: Damp heat, cyclic (12 h + 12 h cycle)	EN 60068-2-30	2005
IEC 60073	2002	Basic and safety principles for man-machine interface, marking and identification - Coding principles for indicators and actuators	EN 60073	2002
IEC 60112	2003	Method for the determination of the proof and the comparative tracking indices of solid insulating materials	EN 60112	2003
IEC 60255 (mod)	Series	Measuring relays and protection equipment	EN 60255	Series
IEC 60417	Data-base	Graphical symbols for use on equipment	-	-
IEC 60617	Data-base	Graphical symbols for diagrams	-	-
IEC 60947-1	2007	Low-voltage switchgear and controlgear - Part 1: General rules	EN 60947-1	2007
IEC 60947-4-1 A1	2000 2002	Low-voltage switchgear and controlgear - Part 4-1: Contactors and motor-starters -	EN 60947-4-1 A1	2001 2002
A2	2005	Electromechanical contactors and motor-starters	A2	2005

<sup>1)</sup> EN 60068-2-6 is superseded by EN 60068-2-6:2008, which is based on IEC 60068-2-6:2007.

<sup>2)</sup> EN 60068-2-27 is superseded by EN 60068-2-27:2009, which is based on IEC 60068-2-27:2008.

**BS EN 60947-5-1:2004+A1:2009**  
**EN 60947-5-1:2004+A1:2009**

<u>Publication</u>	<u>Year</u>	<u>Title</u>	<u>EN/HD</u>	<u>Year</u>
IEC 60947-5-5 A1	1997 2005	Low-voltage switchgear and controlgear - Part 5-5: Control circuit devices and switching elements - Electrical emergency stop device with mechanical latching function	EN 60947-5-5 A1	1997 2005
IEC 61000-4-2 A1 A2	1995 1998 2000	Electromagnetic compatibility (EMC) - Part 4-2: Testing and measurement techniques - Electrostatic discharge immunity test	EN 61000-4-2 A1 A2	1995 <sup>3)</sup> 1998 2001
IEC 61000-4-3 A1	2006 2007	Electromagnetic compatibility (EMC) - Part 4-3: Testing and measurement techniques - Radiated radio-frequency, electromagnetic field immunity test	EN 61000-4-3 A1	2006 2008
IEC 61000-4-4	2004	Electromagnetic compatibility (EMC) - Part 4-4: Testing and measurement techniques - Electrical fast transient/burst immunity test	EN 61000-4-4	2004
IEC 61000-4-5	2005	Electromagnetic compatibility (EMC) - Part 4-5: Testing and measurement techniques - Surge immunity test	EN 61000-4-5	2006
IEC 61000-4-6	2008	Electromagnetic compatibility (EMC) - Part 4-6: Testing and measurement techniques - Immunity to conducted disturbances, induced by radio-frequency fields	EN 61000-4-6	2009
IEC 61000-4-8 A1	1993 2000	Electromagnetic compatibility (EMC) - Part 4-8: Testing and measurement techniques - Power frequency magnetic field immunity test	EN 61000-4-8 A1	1993 2001
IEC 61000-4-11	2004	Electromagnetic compatibility (EMC) - Part 4-11: Testing and measurement techniques - Voltage dips, short interruptions and voltage variations immunity tests	EN 61000-4-11	2004
IEC 61000-4-13	2002	Electromagnetic compatibility (EMC) - Part 4-13: Testing and measurement techniques - Harmonics and interharmonics including mains signalling at a.c. power port, low frequency immunity tests	EN 61000-4-13	2002
IEC 61140 A1 (mod)	2001 2004	Protection against electric shock - Common aspects for installation and equipment	EN 61140 A1	2002 2006
CISPR 11 (mod) + A1 (mod) A2	2003 2004 2006	Industrial scientific and medical (ISM) radio-frequency equipment - Electromagnetic disturbance characteristics - Limits and methods of measurement	EN 55011 A2	2007 2007

<sup>3)</sup> EN 61000-4-2 is superseded by EN 61000-4-2:2009, which is based on IEC 61000-4-2:2008.

**Annex ZZ**  
(informative)**Coverage of Essential Requirements of EC Directives**

This European Standard has been prepared under a mandate given to CENELEC by the European Commission and the European Free Trade Association and within its scope the standard covers all relevant essential requirements as given in Article 4 of the EC Directive 89/336/EC.

Compliance with this standard provides one means of conformity with the specified essential requirements of the Directive[s] concerned.

WARNING: Other requirements and other EC Directives may be applicable to the products falling within the scope of this standard.

---

<http://www.china-gauges.com/>

---

## BSI - British Standards Institution

BSI is the independent national body responsible for preparing British Standards. It presents the UK view on standards in Europe and at the international level. It is incorporated by Royal Charter.

### Revisions

British Standards are updated by amendment or revision. Users of British Standards should make sure that they possess the latest amendments or editions.

It is the constant aim of BSI to improve the quality of our products and services. We would be grateful if anyone finding an inaccuracy or ambiguity while using this British Standard would inform the Secretary of the technical committee responsible, the identity of which can be found on the inside front cover. Tel: +44 (0)20 8996 9000. Fax: +44 (0)20 8996 7400.

BSI offers members an individual updating service called PLUS which ensures that subscribers automatically receive the latest editions of standards.

### Buying standards

Orders for all BSI, international and foreign standards publications should be addressed to Customer Services. Tel: +44 (0)20 8996 9001. Fax: +44 (0)20 8996 7001 Email: [orders@bsigroup.com](mailto:orders@bsigroup.com) You may also buy directly using a debit/credit card from the BSI Shop on the Website <http://www.bsigroup.com/shop>

In response to orders for international standards, it is BSI policy to supply the BSI implementation of those that have been published as British Standards, unless otherwise requested.

### Information on standards

BSI provides a wide range of information on national, European and international standards through its Library and its Technical Help to Exporters Service. Various BSI electronic information services are also available which give details on all its products and services. Contact Information Centre. Tel: +44 (0)20 8996 7111 Fax: +44 (0)20 8996 7048 Email: [info@bsigroup.com](mailto:info@bsigroup.com)

Subscribing members of BSI are kept up to date with standards developments and receive substantial discounts on the purchase price of standards. For details of these and other benefits contact Membership Administration. Tel: +44 (0)20 8996 7002 Fax: +44 (0)20 8996 7001 Email: [membership@bsigroup.com](mailto:membership@bsigroup.com)

Information regarding online access to British Standards via British Standards Online can be found at <http://www.bsigroup.com/BSOL>

Further information about BSI is available on the BSI website at <http://www.bsigroup.com>

### Copyright

Copyright subsists in all BSI publications. BSI also holds the copyright, in the UK, of the publications of the international standardization bodies. Except as permitted under the Copyright, Designs and Patents Act 1988 no extract may be reproduced, stored in a retrieval system or transmitted in any form or by any means – electronic, photocopying, recording or otherwise – without prior written permission from BSI.

This does not preclude the free use, in the course of implementing the standard, of necessary details such as symbols, and size, type or grade designations. If these details are to be used for any other purpose than implementation then the prior written permission of BSI must be obtained.

Details and advice can be obtained from the Copyright and Licensing Manager. Tel: +44 (0)20 8996 7070 Email: [copyright@bsigroup.com](mailto:copyright@bsigroup.com)