

IRAM STANDARD 2073
October 1996*
ICS 29.120.30
****CNA 5935**

GROUNDING BIPOLAR PLUGS FOR RESIDENTIAL USE
10A AND 20A – 250 V AC

* This standard replaces and supersedes IRAM Standard 2073:1982

** CNA stands for Clase Nacional de Abastecimiento (National Supply Classification) assigned by the National Classification Service of the Ministry of Defense

Foreword

This standard has been reviewed by the conforming entities, made up in the following way:

Outlet and Plug Subcommittee:

Representative

F. Andribet
 D. Baez
 E. Bass
 R. Bogliano
 J. Cannone
 C. Colombo
 N. Corrado
 R. García
 F. Cutillo
 H. Expósito
 J. Flores
 A. Iaconis
 E. Lapiduz
 S. Laguzzi
 F. Mazzoni
 J. Pujol
 A. Suchowolski
 C. Sverdloff
 A. Toscano
 G. Zucal
 R. Stanglini

Organization

Enre
 Cafaemeh
 Richi
 Caema
 Plasnavi
 Philips
 Edy
 Radio Victoria
 Commerce Secreatriat
 Kalop
 Exultt
 Covre
 Afarte
 Kalop
 Sica
 New-San
 Electrodomésticos Aurora
 New-San
 M.C.B.A
 Adelco
 Instituto IRAM

Standards General Committee (C.G.N.)

Dr. V. Alderuccio
 Ing. J. Arcioni
 Ing. J. V. Casella
 Dr. E. Catalano
 Ing. D. Donegani
 Lic. C.A. Grimaldi
 Dr. A. Grosso
 Ing. S. Ituarte

Ing. J. Kostic
 Ing. J. Mangosio
 Ing. S. Mardyks
 Ing. R. Martínez
 Ing. N. O'Neill
 Dr. A. F. Otamendi
 Sr. F. R. Soldi
 Prof. M.P. Mestanza

IRAM, the Argentine Standardization Institute is a civil non-profit organization whose main aim is to establish unrestrained technical standards within its scope of application, and at the same time encourage knowledge and application of that standard as the basis for quality. It is also within IRAM scope of responsibility to enforce the use of the IRAM Seal in accordance with IRAM Standards and its related services inside and outside the country, and to promote quality systems in manufacturing companies to ensure safety to the consumer.

In Argentina, IRAM is the representative of the International Organization for Standardization (ISO), the Comisión Panamericana de Normas Técnicas (COPANT) (Panamerican Committee for Technical Standards) and the Standardization Committee of the Mercosur (Southern Common Market

Grounded Bipolar Plugs for Residential Use

10A and 20A – 250 V AC

ICS 29.120.30

**CNA 5935

Introduction

In view of the decision reached by the Secretariat of Trade to establish a single normative system for Plugs and Outlets that might be included in one of the two resolutions of the Secretariat or in any other applicable resolution, the IRAM was requested through a specific committee to establish a system to be enforced in the country.

This committee, considering the power voltage used at national level, the safety of the system, the effect in the economies of all sectors and the aspects derived from imports, etc. unanimously approved the system established by resolution N° 63 of the Trade Secretariat containing IRAM standards 2071 and 2073, that is to say a system of plugs and outlets with flat pins in a 120° arrangement with triangular configuration.

On the other hand, and in order to compensate for household appliances and the like operating with 10 A or more, it was decided to include 20 A, 250 AC plug and outlet assembly mentioned in IEC 83, standard sheet A 10–20 (UL 498 Figure 81.17) which originated the review of this standard in order to include the corresponding IEC 83 plug.

According to the most updated trends, this standard establishes 250 V power voltage, but can also be applied to plugs previously identified whose power voltage ranges between 220 V and 250 V.

Index

	Paragraph	Item	Page
	1	Objective and Scope	6
	2	Standards for Consultation	6
	3	Definitions	6
	4	Requirements	7
	4.1	General Characteristics	7
	4.2	Standardized Values	7
	4.3	Connections	7
	4.4	Shape of the plug	7
	4.5	Dimensions	7
	4.6	Insulating Distance	8
	4.7	Wall Thickness	9
	4.8	Procedure	10
	4.9	Flammability	11
	4.10	Contact with outlet sheets	11
	5	Inspection and Reception	12
	5.1	Type Tests	12
	5.2	Lot Tests	12
	6.	Test Methods	12
	6.1	Test Requirements	12
	6.2	Measurements	13
	6.3	Contact	13
	Annex A	(Normative)	16
	Annex B	(Informative) Bibliography	17

1. **Objective and Scope**

- 1.1 To establish the necessary standards for 10 A and 20 A 250 AC grounded bipolar plugs to be used in residential wiring circuits within a power range of 220 V and 250 V AC.
- 1.2 Neither plugs for industrial usage nor plugs to be used in explosive environments, with corrosive gases or in wiring circuits on board shall be included in this standard.

2. **Standards for Consultation**

The following standards include provisions which, whenever quoted in this document shall be considered valid for this IRAM standard. Issues indicated were effective at the moment of publication. All the standards may be subject to revision and the parties entering agreements based on this standard shall make their best effort to use the latest revisions. IEC and IRAM shall keep updated records of the standards.

IRAM 15:1973: Sampling Plans

IRAM 2006:1983: Plug General Characteristics

IRAM 2007:1995: Flammability Test

IEC 83:1975, A 10–20 Standard Sheet – 20 A Plug Format

UL 498:1980. Figures 81.17 – 20 A Plug Format

3. **Definitions**

- 3.1 **Plug:** movable device with contact pins which, attached to the end of a wire has the purpose to temporarily connect an appliance to the coupling outlet or socket.
- 3.2 **Nominal Voltage:** main voltage for which the plug has been built according to the manufacturer's specification.
- 3.3 **Nominal Current:** constant maximum current for which the plug has been built according to the manufacturer's specifications.

4. Requirements

4.1 General Characteristics

Plugs shall entirely comply with IRAM 2006:1980 standard except that this standard indicates any other procedure.

4.2 Standardized Values

4.2.2 Nominal voltage standardized value shall be 250 V, effective.

4.2.3 Nominal current standardized value shall be 10 A or 20 A, effective.

4.3 Connections

In compound plugs, terminals shall allow 1,5 mm² to 2,5 mm² wires for 10 A, and 4 mm² for 20A plugs. The fastening device shall be suitable for wire O.D. within a range of 9 mm. and 12 mm. for 10 A, and within 13 and 14 mm. for 20 A plugs. Please refer to IRAM 2158 standard.

Note: Should special wires be used, the characteristics of the fastening device shall be established previously.

4.4 Shape of the Plug

Plug shape shall allow easy manual plugging-in and unplugging in such a way to be easily plugged-in and unplugged, without forcing the wire. The useful length of the plug shall not be smaller than 15 mm.

4.5 Dimensions

Plug dimensions shall be determined according to Paragraphs 6.2 to 6.2.6 shall be those indicates in Table 1, Figure 1.

Table 1

Plug Dimensions (mm.)

Plug	a	b	c	d	e	f	g
10A	6,25	7,92	7,92	10,3	1,55 ± 0,07	21,4 ± 0,2	18,2 ± 0,2
20A	7,80 to 8,18	9,53	9,53	11,1	1,78 to 2,03	21,4* to 22,2	17,45 to 18,2*
* Preferred dimensions							

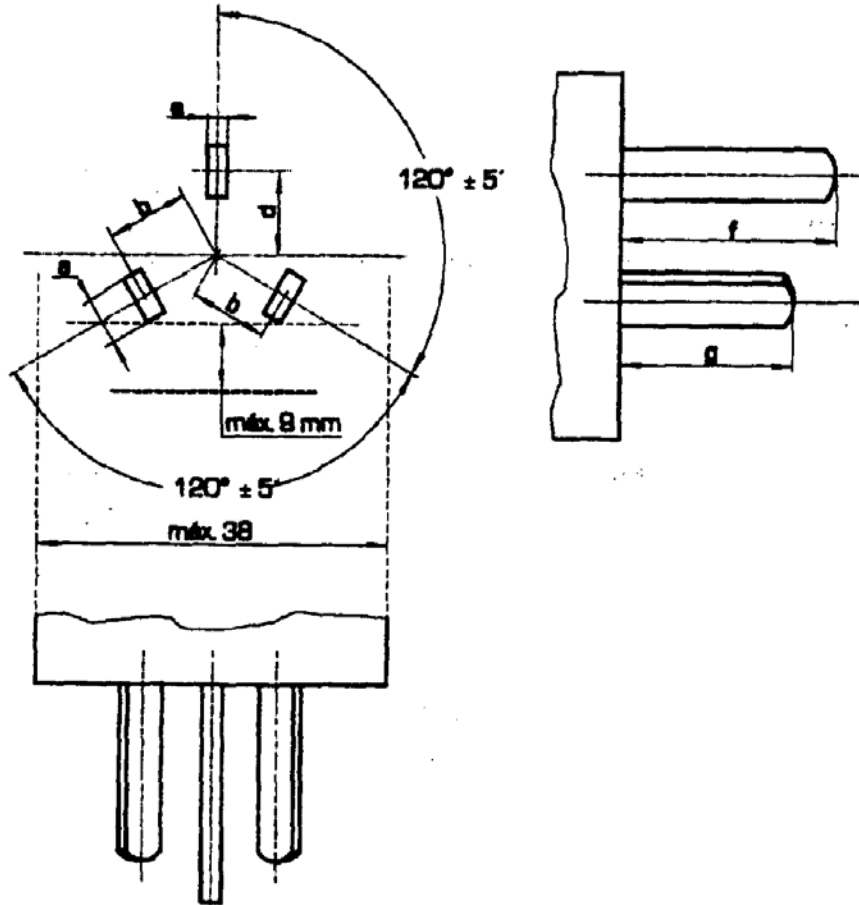

Reference:

————— Manufacturing limit (profiles not included)

Note: measures are given in mm.

Figure 1 – Plug Dimensions

4.5.2 Ends of connecting pins shall be adequately machined. Figures 2a and 2b provide examples of the adequate shapes.



Figura 2a



Figura 2b

4.6 Insulating Distance

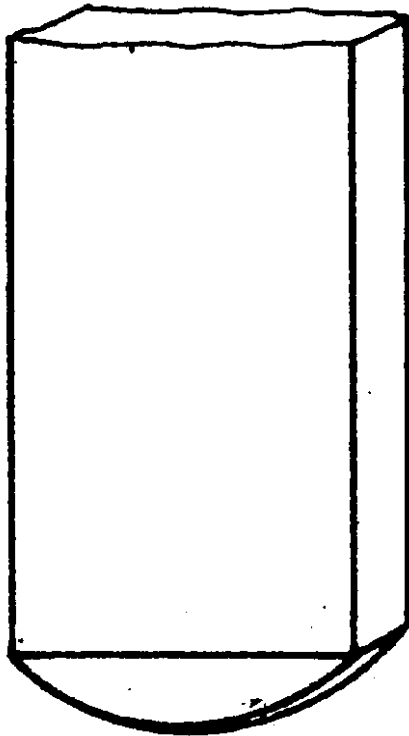
Distance between parts with different polarity voltage and between non-conductive metallic parts shall not be smaller than 3 mm. Distance between parts with different polarity voltage and the external perimeter of the plug shall not be smaller than that necessary to fulfill the dice test indicated in IRAM Standard 2006. In any of the cases, it shall not be smaller than 8 mm.

4.7 Wall Thickness

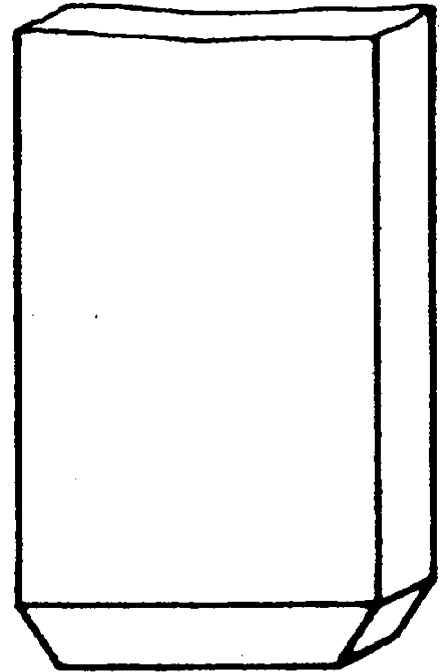
Plug wall thickness in the area where the pins are introduced shall not be smaller than 3 mm. in compound plugs (basis and cover) and 10 mm. in injected plugs (one piece). This thickness shall remain constant around the pins up to no less than 3 mm. on both sides of the plug.

4.8 Manufacturing

4.8.1 Compound Plugs

Plug basis and cover shall be tightly secured one to the other making it impossible to withdraw the cover without the use of a tool when the plug is connected to the respective outlet.

4.8.1.2 Inside metallic parts of different polarity shall be separated by insulating material and shall be part of the plug.

4.8.1.3 The fastening device for the wire shall not penetrate the insulation and shall give good proof of its action.

4.8.2 Injected and Compound Plugs

4.8.2.1 Arrangement of pins shall be that indicated in Figure 3.

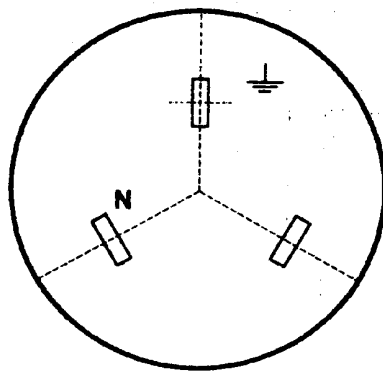

Figure 3 – View from the Pins

4.8.2.2 The grounded terminal shall be identified with the symbol () and the neutral

terminal with the symbol N.

4.8.2.3 Injected plugs shall comply with the tests indicated in 24.4, 24.5 and 24.10, IEC 884 –1/1994.

4.9 Flammability

Plug material shall meet specifications described in Paragraph 23.1, IRAM Standard 2007:1994.

4.10 Outlet Contact Sheets

Plugs shall be manufactured in such a way that, if tested according to Paragraph 6.3 the following results are met:

- a) the grounded pins shall not be in contact with the sheets under voltage of the reference outlet,
- b) the phase and neutral pins shall be simultaneously connected to the contact sheets.

5. *Inspection and Reception*

5.1 Type Tests

5.1.1 Six samples shall be subject to all tests indicated in the Chapters 4 and 6, which shall be carried out in the sequence there established.

5.1.2 The type shall be approved if all the 6 samples meet the specifications of this standard.

5.2 Lot Test

5.2.1 Units of the same model that meet the type specifications described in 5.1 shall be grouped together in lots.

5.2.2 From these lots, samples shall be taken according to the quantity indicated in IRAM 15 standard: for simple sampling plan, normal inspection and special inspection level S–3. These samples shall comply with requirements stated in Paragraphs 4.5 to 4.8.2.3 in this standard and IRAM 2006:1980 5–1, 4.2.2, 4.2.3, 4.2.4, 4.2.6 and 4.3.2.

5.2.3 Any lot shall be considered approved if the amount of faulty units is smaller or equal to the acceptance number $AQL = 2,5\%$

6. Test Methods

6.1 Test Requirements

Tests indicated in this standard shall be carried out with plugs in condition of usage, that is to say with the corresponding wires attached to the respective terminals.

6.2 Dimensions

6.2.1 Width, length and thickness of pins shall be checked with a “GNG” (go–no go) gage whose dimensions can be found in Table 2, Figure 4.

Table 2

Plug Type		Poles and Ground		Length L	
		a	e	Poles	Ground
10 A	Go (mm)	6,36 + 0,01		18,4 ± 0,01	21,60 ± 0,01
		0			
20 A		8,20 ± 0,02	2,10 ± 0,02	18,4 ± 0,02	22,3 ± 0,02
10 A	No Go (mm)	6,14 0	1,47 0	9,10 ± 0,5	10,70 ± 0,5
		-0,01	-0,01		
20 A		7,70 ± 0,02	1,70 ± 0,02	Non defined	Non defined

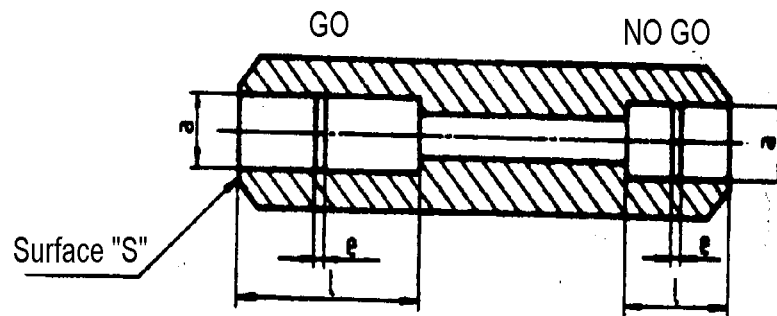

Figure 4 – Go–No Go Gage

6.2.2 In order to carry out the necessary verification with a Go No–Go gage, it shall be introduced without exerting any force on each contact pin. Surface “S” shall contact the external area of the plug. Then, a wall thickness gage 0,5 mm. for plugs 10 A, and a 1 mm. gage for 20 A shall be placed at the bottom of the gage and the pins shall be introduced as described before. Surface S of the “Go” gage shall not be in contact with the external part of the plug. Pins shall not penetrate the “No Go” gage in any position.

6.2.3 Blade arrangement shall be checked using a reference outlet with dimensions indicated in Table 3, Figure 5.

6.2.4 Tests indicated in IRAM 2006 Standard shall be carried out with a reference outlet with the dimensions indicated in Table 4, Figure 6. Contact sheets shall be made in phosphorous bronze with adequate resilience. Connections shall be made with copper wire 1,8 mm. diameter for 10 A plugs and 2,2 mm. for 20 A.

Table 3

Reference outlet for pin verification (mm.)

Reference outlet	a	b	C	d	e	f	Width of contact sheets
10 A	7 ± 0,05	7,92 ± 0,025	7,92 ± 0,025	10,3 ± 0,025	2,2 ± 0,05	21,6 ± 0,05	6,25 ± 0,02
20 A	8,9 ± 0,02	9,53 ± 0,02	9,53 ± 0,02	11,1 ± 0,02	2,65 ± 0,02	22,3 ± 0,05	7,80 ± 0,02

6.2.5 Reference outlet shall be checked with a gage whose measures are indicated in Table 4, Figure 6. Each contact sheet shall resist Mnd mass and the pin shall not detach. With mass Md, the pin shall detach before 5 s.

Note: Dimensions in mm.

Figure 5

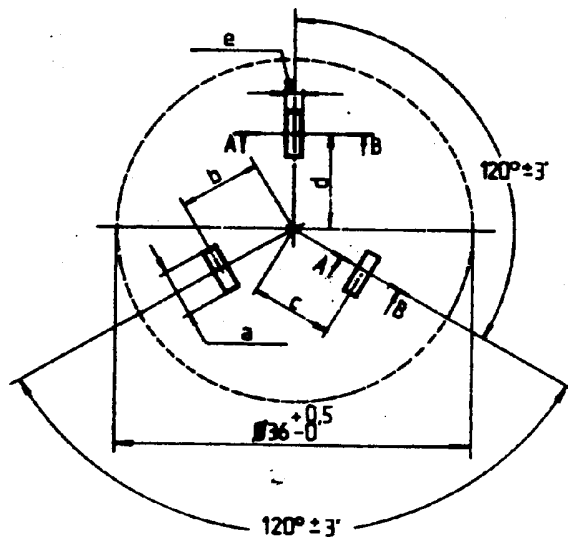

Dimensions for gage for reference outlet/socket verification

Type	a (mm)	e (mm)	L (mm)	Md (kg)	Mnd (kg)
10 A	$6,25 \pm 0,02$	$1,55 \pm 0,025$	Poles: $18,2 \pm 0,2$	1,5	0,5
20 A	$7,8 \pm 0,02$	$2,41 \pm 0,02$	Ground: $21,4 \pm 0,2$	1,5	0,5

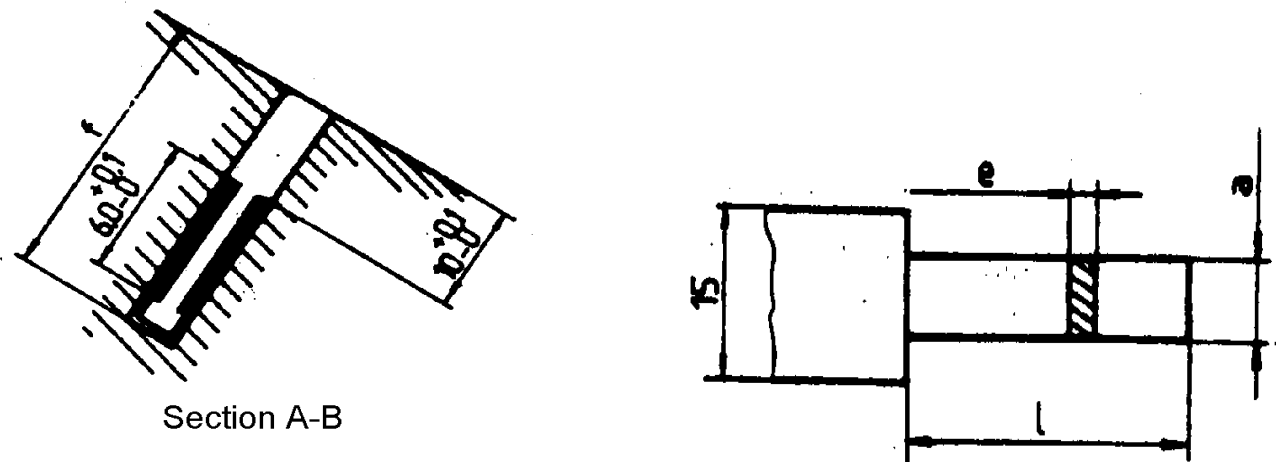

Figure 6

6.2.6 Dimensions which do not use standardized gages shall be verified with measuring instruments that allow a reading of 0,01 mm.

6.3 Contact

The reference outlet whose dimensions are indicated in Figure 5 shall be used to verify that the grounded pin in the plug does not contact the sheets under voltage of the reference outlet, and that the phase and neutral pins of the plug penetrate at the same time in the sheets under voltage.

ANNEX A

(Normative)

- A.1 Plug 20 A characteristics and dimensions are established according to IEC 83, standard sheet A 10–20 which in turn corresponds to Figure 87.17 UL 498.
- A.2 As an example, IEC 83 standard specification sheet is attached.

Notes: **1:** In this standard no optional holes are specified
2: In this standard, no shape in pins is specified

Annex B

(Informative)

Bibliography

The following material has been used in the revision of the standard:

- IRAM: Instituto Argentino de Racionalización de Materiales. IRAM 2073:1982. Grounded bipolar plugs to be used with socket-outlet and plug for fixed residential facilities with 220 V power voltage.
- IEC: International Electrotechnical Commission. IEC 83:1975 – Socket-outlet and plug for domestic and similar general use Standard A 10–20
- UL: (Underwriters Laboratories) UL 498 – Attachment plugs and receptacles. Figure 81.17

This information has been supplied by the members of the subcommittee. Information belonging to the IRAM is based on the experience obtained in the application of the previous issue of this standard.