

**AS/NZS 60598.2.2:2016**

(IEC 60598-2-2, Ed. 3.0:2011, MOD)

Australian/New Zealand Standard

## **Luminaires**

### **Part 2.2: Particular requirements—Recessed luminaires**

Superseding AS/NZS 60598.2.2:2001



**AS/NZS 60598.2.2:2016**



This joint Australian/New Zealand standard was prepared by joint Technical Committee EL-041, Lamps and Related Equipment. It was approved on behalf of the Council of Standards Australia on 13 November 2015 and on behalf of the Council of Standards New Zealand on 12 February 2016.

This standard was published on 26 February 2016.

---

**The following are represented on Committee EL-041:**

Australian Industry Group  
Consumers Federation of Australia  
Department of Industry  
Electrical Compliance Testing Association  
Electrical Contractors Association of New Zealand  
Electrical Regulatory Authorities Council  
Energy Efficiency and Conservation Authority of New Zealand  
Fair Trading NSW  
IES: The Lighting Society  
Independent Pricing and Regulatory Tribunal  
Institution of Professional Engineers New Zealand  
Joint Accreditation System of Australia and New Zealand  
Lighting Council Australia  
Lighting Council New Zealand  
Master Electricians Australia  
Ministry of Business, Innovation and Employment, New Zealand

Additional Interests:

Australasian Fire and Emergency Service Authorities Council

---

**Keeping standards up to date**

Standards are living documents which reflect progress in science, technology, and systems. To maintain their currency, all standards are periodically reviewed, and new editions are published. Between editions, amendments may be issued. Standards may also be withdrawn. It is important that readers assure themselves they are using a current standard, which should include any amendments which may have been published since the standard was purchased.

Detailed information about joint Australian/New Zealand standards can be found by visiting the standards webshop in Australia at [www.saiglobal.com.au](http://www.saiglobal.com.au) or Standards New Zealand's website at [www.standards.co.nz](http://www.standards.co.nz).

Alternatively, Standards Australia publishes an annual printed catalogue with full details of all current standards. For more frequent listings or notification of revisions, amendments, and withdrawals, Standards Australia and Standards New Zealand offer a number of update options. For information about these services, users should contact their respective national standards organisation.

We also welcome suggestions for improvement in our standards, and especially encourage readers to notify us immediately of any apparent inaccuracies or ambiguities. Please address your comments to the Chief Executive of either Standards Australia or Standards New Zealand at the address shown on the title page.

---

*This standard was issued in draft form for comment as DR AS/NZS 60598.2.2:2015.*

Australian/New Zealand Standard

---

# Luminaires

## Part 2.2: Particular requirements—Recessed luminaires

---

Originated as AS/NZS 60598.2.2:2001.  
Second edition 2016.

### **COPYRIGHT**

© Standards Australia Limited/Standards New Zealand

All rights are reserved. No part of this work may be reproduced or copied in any form or by any means, electronic or mechanical, including photocopying, without the written permission of the publisher, unless otherwise permitted under the Copyright Act 1968 (Australia) or the Copyright Act 1994 (New Zealand).

Jointly published by SAI Global Limited under licence from Standards Australia Limited, GPO Box 476, Sydney, NSW 2001 and by Standards New Zealand, Private Bag 2439, Wellington 6140.

ISBN (Print) 978-1-77664-402-5  
ISBN (PDF) 978-1-77664-403-2

<http://www.china-gauges.com/>

## PREFACE

This Standard was prepared by the Joint Standards Australia/Standards New Zealand Committee EL-041, Lamps and Related Equipment, to supersede AS/NZS 60598.2.2:2001, *Luminaires*, Part 2.2: *Particular requirements—Recessed luminaires (IEC 60598-2-2:1996, MOD)*, 24 months from the date of publication. During this period, both standards will operate in parallel, after which it is anticipated that the 2001 edition will be withdrawn.

The objective of this Standard is to provide manufacturers, users and regulators with electrical safety requirements for recessed luminaires.

This Standard is an adoption with national modifications; it has been reproduced from IEC 60598-2-2, Ed. 3.0 (2011), *Luminaires*, Part 2-2: *Particular requirements—Recessed luminaires*, and has been varied as indicated to take account of Australian/New Zealand conditions.

Variations made to IEC 60598-2-2, Ed. 3.0 (2011) form the Australian/New Zealand variations for the purposes of the IECEE CB Scheme for recognition of testing to standards for safety of electrical equipment (the CB Scheme). They are listed in Appendix ZZ.

Appendix ZA has been added to set out the thermal test procedures for Australia/New Zealand.

Appendices ZB, ZC and ZD have been added to provide examples of methods satisfying the requirements for the supply of information specified in Appendix ZZ; examples of recessed luminaires; and guidance on classifications.

This Standard is structured as follows:

- (a) Preface.
- (b) IEC 60598-2-2, Ed. 3.0 (2011), unedited from the contents page to the final clause of the source document.
- (c) Appendix ZZ—Australian/New Zealand variations to the source document.
- (d) Appendices ZA, ZB, ZC and ZD.

The variations listed in Appendix ZZ include the following:

- (i) Classifications and definitions of different types of recessed luminaire in relation to use near, or being covered with, building elements or thermal insulation, or both.
- (ii) Tests, including ingress protection tests and thermal tests for normal and abnormal operating conditions, and marking and instructional requirements for the different classifications of recessed luminaire, with standardized test box and temperature limits, and requirements for any thermal protection.

As this Standard is reproduced from an International Standard, the following applies:

- (A) In the source text ‘this part of IEC 60598’ should read ‘this Australian/New Zealand Standard’.
- (B) A full point substitutes for a comma when referring to a decimal marker.

References to International Standards should be replaced by references to Australian or Australian/New Zealand Standards, as follows:

<i>Reference to International Standard</i>		<i>Australian/New Zealand Standard</i>	
IEC		AS/NZS	
60227	Polyvinyl chloride insulated cables of rated voltages up to and including 450/750 V	60227	Polyvinyl chloride insulated cables of rated voltages up to and including 450/750 V
60227-5	Part 5: Flexible cables (cords)	60227.5	Part 5: Flexible cables (cords)

IEC		AS/NZS	
60245	Rubber insulated cables—Rated voltages up to and including 450/750 V	60245	Rubber insulated cables—Rated voltages up to and including 450/750 V
60245-4	Part 4: Cords and flexible cables	60245.4	Part 4: Cords and flexible cables
60598	Luminaires	60598	Luminaires
60598-1	Part 1: General requirements and tests	60598.1	Part 1: General requirements and tests

Only normative references that have been adopted as Australian or Australian/New Zealand Standards have been listed.

The terms ‘normative’ and ‘informative’ have been used in this Standard to define the application of the annex or appendix to which they apply. A ‘normative’ annex or appendix is an integral part of a Standard, whereas an ‘informative’ annex or appendix is only for information and guidance.

In this Standard, the terms ‘clause’ and ‘section’ give effect to the same meaning and may be used interchangeably.

It has been assumed in the drafting of this Standard that the execution of its provisions is entrusted to appropriately qualified and experienced persons.

The essential safety requirements in AS/NZS 3820, *Essential safety requirements for electrical equipment*, that could be applicable to lighting products within the scope of this Standard, are covered by this Standard, taken in conjunction with any other relevant requirements affecting safety.

## CONTENTS

2.1	Scope.....	5
2.2	Normative references .....	5
2.3	General test requirements .....	5
2.4	Definitions .....	5
2.5	Classification of luminaires .....	5
2.6	Marking .....	5
2.7	Construction .....	5
2.8	Creepage distances and clearances .....	5
2.9	Provision for earthing .....	6
2.10	Terminals .....	6
2.11	External and internal wiring .....	6
2.12	Protection against electric shock .....	6
2.13	Endurance tests and thermal tests .....	6
2.14	Resistance to dust and moisture.....	7
2.15	Insulation resistance and electric strength .....	7
2.16	Resistance to heat, fire and tracking .....	7
	Annex A (informative) Measurement of ambient temperature in an installation .....	8
	Table 1 – Operating temperature of cable .....	7

## AUSTRALIAN/NEW ZEALAND STANDARD

**Luminaires****Part 2.2:  
Particular requirements—Recessed luminaires  
(IEC 60598-2-2, Ed. 3.0 (2011) MOD)****2.1 Scope**

This part of IEC 60598 specifies requirements for recessed luminaires incorporating electric light sources for operation from supply voltages up to 1 000 V. This section does not apply to air-handling or liquid-cooled luminaires.

**2.2 Normative references**

The following referenced documents are indispensable for the application of this document. For dated references, only the edition cited applies. For undated references, the latest edition of the referenced document (including any amendments) applies.

IEC 60227 (all parts), *Polyvinyl chloride insulated cables of rated voltages up to and including 450/750 V*

IEC 60245 (all parts), *Rubber insulated cables – Rated voltages up to and including 450/750 V*

IEC 60598-1, *Luminaires – Part 1: General requirements and tests*

**2.3 General test requirements**

The provisions of section 0 of IEC 60598-1 apply. The tests described in each appropriate section of part 1 shall be carried out in the order listed in this section of part 2.

A procedure measuring ambient temperature in an installation is given in Annex A.

**2.4 Definitions**

For the purposes of this document, the definitions of Section 1 of IEC 60598-1 apply.

**2.5 Classification of luminaires**

Luminaires shall be classified in accordance with the provisions of Section 2 of IEC 60598-1.

**2.6 Marking**

The provisions of Section 3 of IEC 60598-1 apply.

**2.7 Construction**

The provisions of Section 4 of IEC 60598-1 apply.

**2.8 Creepage distances and clearances**

The provisions of Section 11 of IEC 60598-1 apply.

## 2.9 Provision for earthing

The provisions of Section 7 of IEC 60598-1 apply.

## 2.10 Terminals

The provisions of Sections 14 and 15 of IEC 60598-1 apply.

## 2.11 External and internal wiring

The provisions of Section 5 of IEC 60598-1 apply.

Flexible cables or cords used as a means of connection to the supply, when supplied by the luminaire manufacturer, shall be at least equal in their mechanical and electrical properties to those specified in IEC 60227 or IEC 60245 and shall be capable of withstanding without deterioration the highest temperature to which they may be exposed under normal conditions of use. Materials other than p.v.c. and rubber are suitable if the above requirements are met.

*Compliance shall be checked by the tests specified in 2.13.*

NOTE The use of flexible cables and cords with recessed luminaires is appropriate for the following reasons:

- 1) The flexible cable or cord cannot be easily touched as it is normally out of reach within the recess.
- 2) To facilitate installation of the luminaire into the recess.
- 3) To permit the adjustment of settable and adjustable recessed luminaires.

## 2.12 Protection against electric shock

The provisions of Section 8 of IEC 60598-1 apply.

The parts of the luminaire and components within the ceiling space or cavity shall provide the same degree of protection against electric shock as the luminaire parts below the ceiling space.

NOTE The ceiling space or cavity is regarded as accessible for installation and maintenance, and the barriers do not provide adequate protection against electric shock.

*Compliance is checked by inspection.*

## 2.13 Endurance tests and thermal tests

The provisions of Section 12 of IEC 60598-1 apply together with the requirements of 2.13.1.

**2.13.1** Wiring, for connection to the supply, which passes into or can touch the luminaire shall not reach unsafe temperature.

*Compliance shall be checked by the following tests:*

*The luminaire is connected to the supply using the cable provided with the luminaire or using a cable in accordance with the marking on the luminaire or, if not marked, as specified in the manufacturer's instruction sheet; otherwise PVC cable complying with IEC 60227 is used.*

*The hottest point is found (along the internal route or on the outer surface of the luminaire) with which the cable is likely to lie in contact during normal service. The cable is lightly held in contact at this point and the temperature of the insulation at the point of contact is measured as described in Annex K of IEC 60598-1.*

*The operating temperature of the cable shall not exceed the limits given in Table 1.*



*Luminaires with an IP classification greater than IP20 shall be subjected to the relevant tests of Clauses 12.4, 12.5, 12.6 and 12.7 of Section 12 of IEC 60598-1 after the test(s) of Clause 9.2 but before the test(s) of Clause 9.3 of Section 9 of IEC 60598-1 specified in Clause 2.14 of this section of IEC 60598-2.*

**Table 1 – Operating temperature of cable**

Designation of cable	Limit of operating temperature
Cable (including sleeves) provided with the luminaire	The maximum temperature specified in Table 12.2 of IEC 60598-1
Cable not provided with the luminaire:	
a) luminaires with cable temperature marking	The marked temperature
b) luminaires without cable temperature marking	The maximum temperature specified in Table 12.2 of IEC 60598-1 for ordinary PVC not subject to mechanical stress

#### **2.14 Resistance to dust and moisture**

The provisions of Section 9 of IEC 60598-1 apply.

For luminaires with an IP classification greater than IP20, the order of the tests specified in Section 9 of IEC 60598-1 shall be as specified in Clause 2.13 of this section of IEC 60598-2.

#### **2.15 Insulation resistance and electric strength**

The provisions of Section 10 of IEC 60598-1 apply.

#### **2.16 Resistance to heat, fire and tracking**

The provisions of Section 13 of IEC 60598-1 apply.

## Annex A (informative)

### Measurement of ambient temperature in an installation

Considerable care is needed in deciding whether a recessed luminaire is operating within its thermal limits in an existing lighting installation. It is even more difficult to predict whether a luminaire will be satisfactory in a proposed installation and a "mock-up" is usually required. In the past, there have been instances of overheating of luminaires, for example, overheating owing to the presence of heating services above the ceiling plane.

The following procedure is for measuring the ambient temperature in which the luminaire operate. The  $t_a$  rating of the luminaire should be at least equal to this ambient temperature. The ambient temperature is measured in the plane of the ceiling (or other mounting surface) at the mid-point of a typical cavity. It is important that all other luminaires in the installation and all other services which may affect the thermal conditions of the luminaire are operating. The cavity is covered above the measuring point to prevent a non-typical interchange of air and so that the cover may absorb extraneous heat which would be absorbed by the luminaire.

NOTE It may be convenient to insert for this purpose the shell of the luminaire.

The test recess used to measure operating temperatures of recessed luminaires is intended to represent the most onerous closed recess (without other heat source) which is likely to be experienced in service. A recessed luminaire should not be installed in a cavity with a volume smaller than that of the test recess, unless the manufacturer of the luminaire has verified that operation will be satisfactory.

The test recess may also approximate to the thermal conditions above a suspended ceiling if the larger air volume is offset by heat-emitting services. In a particular installation, more onerous thermal conditions than this may exist and it is, therefore, essential to carry out a practical check. Conversely, the space above the ceiling may have free air movement and no heat-emitting services; for such an installation, the  $t_a$  rating of the luminaire as determined in the test recess incorporates a temperature margin and the  $t_a$  rating may be exceeded if the manufacturer of the luminaire has verified that operation in the particular installation will be satisfactory.

During tests, to determine or check a  $t_a$  rating for a luminaire, measurements of ambient temperature are made inside the draught-proof enclosure and outside the test recess in accordance with Annex K of IEC 60598-1.

## APPENDIX ZZ

VARIATIONS TO IEC 60598-2-2, ED. 3.0 (2011) FOR AUSTRALIA AND  
NEW ZEALAND

(Normative)

**ZZ1 SCOPE**

This Appendix sets out variations to IEC 60598-2-2, Ed. 3.0 (2011) for Australia and New Zealand, including additional requirements to cover issues not addressed by the International Standard. These variations indicate national variations for the purpose of the IECEE CB Scheme and will be published in the IECEE *CB Bulletin*.

**ZZ2 VARIATIONS**

The following variations are required in Australia and New Zealand:

**Clause****2.1**

At the end of 2.1, *add* the following text:

This part also specifies the safety requirements for recessed luminaires to provide adequate protection in respect of the fire risk associated with the combination of recessed luminaires with flammable building elements, flammable debris and building insulation.

This Standard is to be read in conjunction with AS/NZS 60598.1.

Luminaires within the scope of IEC 60598-2-13, *Luminaires, Part 2-13: Particular requirements—Ground recessed luminaires*, are excluded from this Standard.

**2.2**

*Add* the following new normative references:

AS 60529, *Degrees of protection provided by enclosures (IP Code)*

AS/NZS 4859.1, *Materials for the thermal insulation of buildings — General criteria and technical provisions*

AS/NZS 61347 (all parts), *Lamp controlgear*

IEC 60730-1, *Automatic electrical controls — Part 1: General requirements*

IEC 60730-2 (all parts), *Automatic electrical controls for household and similar use*

IEC 61032, *Protection of persons and equipment by enclosures — Probes for verification*

IEC 62733, *Programmable components in electronic lamp controlgear — General and safety requirements*

**2.3**

*Delete* existing text and *replace* with the following:

The provisions of Section 0 of AS/NZS 60598.1 apply.

The tests specified in each appropriate section of AS/NZS 60598.1 shall be carried out in the order listed in this part for all luminaires other than those with an IP rating greater than IP2X and those classified as CA90, CA135, IC and IC-4.

For luminaires with an IP classification greater than IP2X, and those classified as CA90, CA135, IC and IC-4, the tests specified in each appropriate section of AS/NZS 60598.1 shall be carried out in the order listed in this part, except for the tests listed in Table ZZ1, which shall be performed in the order listed in Table ZZ1.

**Table ZZ1 — Order of tests of Sections 2.13, 2.14 and 2.15 for luminaires with an IP classification greater than IP2X, or those classified as CA90, CA135, IC or IC-4**

Order	Test	Reference
1	Endurance test of Section 12.3 of AS/NZS 60598.1.	Section 2.13 of this Standard.
2	Test for ingress of dust, solid objects and moisture of Section 9.2 of AS/NZS 60598.1.	Section 2.14 of this Standard.
3	Ingress test (for the appropriate classification) of Section 2.14 of this Standard.	Section 2.14 of this Standard.
4	Thermal test (normal operation) of Section 12.4 of AS/NZS 60598.1 and normal operation test (for the appropriate classification) of Section 2.13 of this Standard. NOTE Apply these tests together as one test.	Section 2.13 of this Standard.
5	Thermal test (abnormal operation) of Section 12.5 of AS/NZS 60598.1. NOTE Conditions 12.5.1 a) 1), 2), 3) and 4) are applied as appropriate.	Section 2.13 of this Standard.
6	Abnormal operation test (for the appropriate classification) of Section 2.13 of this Standard. NOTE Classifications IC and IC-4 do not have this abnormal operation test as their normal test conditions are the same as the abnormal test conditions for other classifications.	Section 2.13 of this Standard.
7	Thermal test (failed windings in lamp controlgear) of Section 12.6 of AS/NZS 60598.1. NOTE Apply test as appropriate, if applicable.	Section 2.13 of this Standard.
8	Thermal test in regard to fault conditions in lamp controlgear or electronic devices incorporated in thermoplastic luminaires of Section 12.7 of AS/NZS 60598.1. NOTE Apply test as appropriate, if applicable.	Section 2.13 of this Standard.
9	Humidity test of Section 9.3 of AS/NZS 60598.1.	Section 2.14 of this Standard.
10	Insulation resistance and electric strength, touch current and protective conductor current tests of Section 10 of AS/NZS 60598.1.	Section 2.15 of this Standard.
<p>NOTE 1 For luminaires of classifications other than those specified in Table ZZ1, the order of tests is as set out in Sections 2.13 to 2.15 of this Standard. For devices not covered by this table, the order of tests in Section 2.13 applies.</p> <p>NOTE 2 For the tests of AS/NZS 60598.1, 12.3, 12.4, 12.5 conditions 12.5.1 a) 1), 2), 3) and 4), 12.6 and 12.7:</p> <ul style="list-style-type: none"> <li>– The appropriate test box of this Standard's normal operation test is used.</li> <li>– Other test conditions are applied as specified in the requirements listed in the particular AS/NZS 60598.1 section and, for 12.4 tests, taking into account the modifications to Section 12.4 of this Standard.</li> </ul>		

Controlgear that complies separately with a relevant standard shall, in addition, be assessed to the requirements of this Standard.

A procedure for measuring ambient temperature in an installation is given in Annex A.

## 2.4

*Delete* existing text and *replace* with the following:

For the purposes of this document, the definitions of Section 1 of AS/NZS 60598.1 apply, along with the following:

### **2.4.101 Non-IC luminaire**

a recessed luminaire that cannot be abutted against or covered by normally flammable materials or used in installations where building insulation or debris is, or may be, present in normal use.

NOTE This classification is not suitable for residential installations.

### **2.4.102 Do-not-cover luminaire**

a recessed luminaire that can be used where normally flammable materials, including building insulation, are or may be present, but cannot be abutted against any material and cannot be covered in normal use.

#### **2.4.103.1 CA90 luminaire**

a recessed luminaire that can be abutted against normally flammable materials, including building insulation, but cannot be covered in normal use. Building elements, building insulation or debris have limited access (see 2.4.106) to the heated parts of the luminaire.

#### **2.4.103.2 CA135 luminaire (New Zealand only)**

a recessed luminaire that can be abutted against normally flammable materials, including building insulation, but cannot be covered in normal use. Building elements, building insulation or debris have some access (see 2.4.107) to the heated parts of the luminaire.

#### **2.4.104.1 IC luminaire**

a recessed luminaire that can be abutted against normally flammable materials, including building insulation, and can be covered in normal use. Building elements, building insulation or debris have limited access (see 2.4.106) to the heated parts of the luminaire.

#### **2.4.104.2 IC-4 luminaire**

a recessed luminaire that can be abutted against normally flammable materials, including building insulation, and can be covered in normal use. Building elements, building insulation or debris have restricted access (see 2.4.108) to the heated parts of the luminaire. This classification of recessed luminaire is effectively a sealed unit that has a restricted flow of air between the habitable room the luminaire emits light into and the void/space where the main body of the luminaire is located.

### **2.4.105 outside surface of the luminaire**

the surface of the luminaire that can be accessed by the probe specified for the classification of the luminaire.

**2.4.106 limited access**

parts accessible to a 5.6 mm diameter probe are not permitted to have surface temperatures exceeding 90 °C under normal operating conditions, excluding the access face.

**2.4.107 some access**

parts accessible to a 50 mm diameter probe are not permitted to have surface temperatures exceeding 135 °C in normal operation, excluding the access face.

**2.4.108 restricted access**

parts accessible to an AS 60529 IP4X probe are not permitted to have surface temperatures exceeding 90 °C in normal operation, including the access face.

**2.4.109 recessed luminaire**

a luminaire designed to be recessed into a ceiling, wall, floor or similar surface with an access face which, when installed on a mounting surface, emits light into one area, while the body of the luminaire is located in a separate area on the other side of the mounting surface to the access face. Includes a light source and any components of the luminaire required for the luminaire to operate.

NOTE 1 Components may include individual components, such as controlgear that is supplied with the luminaire.

NOTE 2 Figure ZC1 in Appendix ZC shows the general parts of a recessed luminaire. Appendix ZC also provides examples of recessed luminaire configurations.

**2.4.110 access face**

the surface of the luminaire that emits light into the habitable room, i.e. the surface of the luminaire located in the space representative of the underside of a ceiling or, for wall-mounted luminaires, the visible wall face.

**2.5**

*Delete* existing text and *replace* with the following:

**2.5.101 General**

Luminaires shall be classified in accordance with the provisions of Section 2 of AS/NZS 60598.1, along with the following.

Luminaires shall be classified according to their suitability for use near, or being covered with, building elements or thermal insulation, or both, in accordance with Clause 2.5.102 for Australia or Clause 2.5.103 for New Zealand.

NOTE Appendix ZD provides information and guidance on the classifications, symbols, applications and general restrictions on recessed luminaires.

**2.5.102 Australian classifications**

Luminaires shall be classified as one of the following:

- a) Non-IC
- b) Do-not-cover
- c) CA90
- d) IC
- e) IC-4

### 2.5.103 New Zealand classifications

Luminaires shall be classified as at least one of the following:

- a) Non-IC
- b) Do-not-cover
- c) CA90
- d) CA135
- e) IC
- f) IC-4

## 2.6

*Delete* existing text and *replace* with the following:

### 2.6.101 General

The provisions of Clause 3 of AS/NZS 60598.1 apply, along with the following:

- Clause 3.2.21 of AS/NZS 60598.1 is replaced by Clause 2.6.102.
- The additional requirements of Clause 2.6.103 and Clause 2.6.104 apply, as applicable.

### 2.6.102 Luminaire symbol marking

Recessed luminaires shall be marked with the symbol shown in the appropriate figure of this Clause, corresponding to their classification in accordance with Clause 2.5.

Non-IC luminaires shall be marked with the symbol shown in Figure 101.

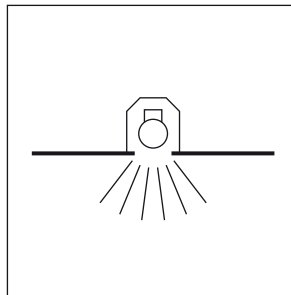

FIGURE 101 REQUIRED SYMBOL FOR NON-IC LUMINAIRES

Exception: For 24 months from the date of publication of this Standard, Non-IC luminaires may be marked with the symbol shown in Figure 201 in lieu of the symbol shown in Figure 101.

24 months from the date of publication of this Standard, this exception will cease to apply.



FIGURE 201 PERMITTED EXCEPTION SYMBOL FOR NON-IC LUMINAIRES

Do-not-cover luminaires shall be marked with the symbol shown in Figure 102.

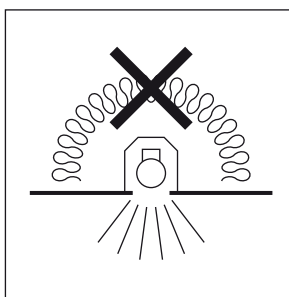

FIGURE 102 REQUIRED SYMBOL FOR DO-NOT-COVER LUMINAIRES

CA90 luminaires shall be marked with the symbol shown in Figure 103.

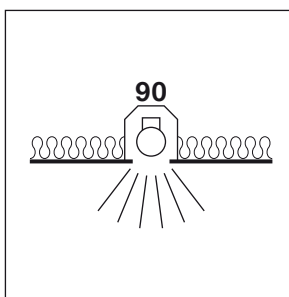

FIGURE 103 REQUIRED SYMBOL FOR CA90 LUMINAIRES

Exception: For 24 months from the date of publication of this Standard, luminaires that comply with the requirements for CA80 luminaires in accordance with AS/NZS 60598.2.2:2001, New Zealand only Amendment A, may be marked with the symbol shown in Figure 202 in lieu of the symbol shown in Figure 103. Such CA80 luminaires are deemed to meet the requirements for CA90 luminaires.

24 months from the date of publication of this Standard, this exception will cease to apply.





FIGURE 202 PERMITTED EXCEPTION SYMBOL FOR CA90 LUMINAIRES (FOR LUMINAIRES THAT COMPLY WITH CA80 REQUIREMENTS OF NEW ZEALAND ONLY AMENDMENT A OF AS/NZS 60598.2.2:2001)

In New Zealand, CA135 luminaires shall be marked with the symbol shown in Figure 104.

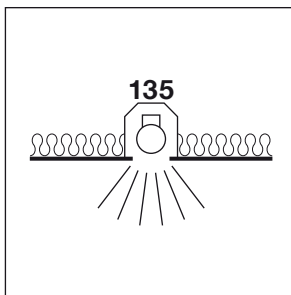

FIGURE 104 REQUIRED SYMBOL FOR CA135 LUMINAIRES—NEW ZEALAND ONLY

Exception: For 24 months from the date of publication of this Standard, CA135 luminaires may be marked with the symbol shown in Figure 203 in lieu of the symbol shown Figure 104.

24 months from the date of publication of this Standard, this exception will cease to apply.



FIGURE 203 PERMITTED EXCEPTION SYMBOL FOR CA135 LUMINAIRES—NEW ZEALAND ONLY

IC luminaires shall be marked with the symbol shown in Figure 105.

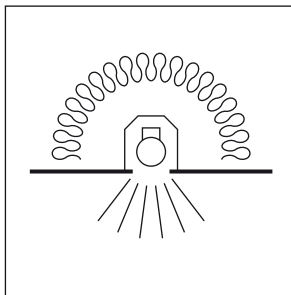

FIGURE 105 REQUIRED SYMBOL FOR IC LUMINAIRES

Exception: For 24 months from the date of publication of this Standard, IC luminaires may be marked with the symbol shown in Figure 204 in lieu of the symbol shown in Figure 105.

24 months from the date of publication of this Standard, this exception will cease to apply.



FIGURE 204 PERMITTED EXCEPTION SYMBOL FOR IC LUMINAIRES

IC-4 luminaires shall be marked with the symbol shown in Figure 106.

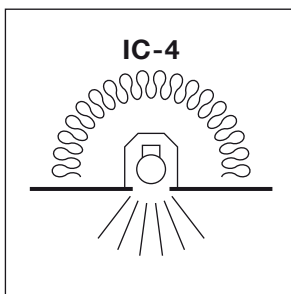

FIGURE 106 REQUIRED SYMBOL FOR IC-4 LUMINAIRES

Exception: For 24 months from the date of publication of this Standard, IC-4 luminaires may be marked with the symbol shown in Figure 205 in lieu of the symbol shown in Figure 106.

24 months from the date of publication of this Standard, this exception will cease to apply.

<http://www.china-gauges.com/>



FIGURE 205 PERMITTED EXCEPTION SYMBOL FOR IC-4 LUMINAIRES

### 2.6.103 Location and durability of marking

The marking required by Clause 2.6.102 shall be—

- a) legible, durable and visible when the luminaire is installed and viewed from behind;
- b) a minimum size of 25 mm × 25 mm; and
- c) permanently marked on the luminaire or on a durable swing tag permanently connected to the luminaire.

The marking shall comply with the durability test requirements of AS/NZS 60598.1.

### 2.6.104 Additional information to be supplied with the luminaire

#### 2.6.104.1 General

All recessed luminaires shall be supplied with installation instructions containing the following information:

- a) The minimum clearance distance from the top of the luminaire to any normally flammable building element.
- b) The minimum clearance distance from the top of the luminaire to any building insulation.
- c) The minimum clearance distance from the side of the luminaire to any normally flammable building element.
- d) The minimum clearance distance from the side of the luminaire to any building insulation.

If the minimum clearance distances from each side of the luminaire are different, or there are different minimum clearance distances for various types of normally flammable building element or building insulation, then each minimum clearance distance shall be stated separately.

NOTE 1 See Appendix ZB for examples of methods satisfying the requirements for the supply of information on minimum clearance distances.

If the luminaire is suitable for installing in a non-combustible enclosed space or non-combustible premade enclosure, and the minimum clearance distances required for installation in that space are different from the distances stated in accordance with the above, the minimum clearance distances for the installation, or premade enclosure details, shall be included in the instructions.

NOTE 2 Installation in a non-combustible enclosed space may include installation in a rebate in a concrete slab, ceiling or wall.

In the section of the instructions where the minimum clearance distances are stated, the following warning shall be included:

**WARNING — RISK OF OVERHEATING OR FIRE IF THE CLEARANCE DISTANCES ARE COMPROMISED.**

NOTE 3 In some classifications of luminaire, the minimum clearance distance from the top or sides of the luminaire to building elements or insulation, or both, may actually be 0 mm (i.e. the material may abut the luminaire on the sides or the top). In these instances, a wording such as 'building insulation may abut the sides of the luminaire' is a suitable alternative to 'the minimum distance from the side of the luminaire to building insulation is 0 mm'.

Luminaires with classification CA135 shall have the additional following warning included:

**WARNING — RISK OF FIRE: THIS LUMINAIRE CANNOT BE INSTALLED ABUTTING THERMAL INSULATION OR OTHER BUILDING ELEMENTS THAT ARE NOT SUITABLE FOR EXPOSURE TO CONSTANT TEMPERATURES OF 135 °C.**

Where a recessed luminaire is required to be mounted on a specific surface or has additional installation requirements to ensure adequate sealing to maintain its IP rating, the relevant information shall be supplied with the luminaire.

#### **2.6.104.2 Additional warning**

##### **2.6.104.2.1 General**

Luminaires shall have additional warnings in accordance with 2.6.104.2.2 for Australia and 2.6.104.2.3 for New Zealand.

##### **2.6.104.2.2 Australia additional warning**

Non-IC luminaires shall be supplied with installation instructions containing the following warning:

**WARNING — THIS LUMINAIRE IS NOT SUITABLE FOR INSTALLATION IN LOCATIONS WHERE THERMAL INSULATION IS PRESENT, OR MAY REASONABLY BE EXPECTED TO BE INSTALLED IN THE FUTURE, OR WHERE THERE IS A LIKELIHOOD OF OTHER COMBUSTIBLE MATERIAL, E.G. LEAVES OR VERMIN DEBRIS, ETC. COLLECTING ON OR AROUND THE LUMINAIRE. IT IS NOT SUITABLE FOR DOMESTIC INSTALLATIONS OR INSTALLATION IN RESIDENTIAL AREAS OF NON-DOMESTIC INSTALLATIONS (RESIDENTIAL INSTITUTIONS, HOTELS, BOARDING HOUSES, HOSPITALS, ACCOMMODATION HOUSES, MOTELS, HOSTELS AND THE LIKE).**

##### **2.6.204.2.3 New Zealand additional warning**

Non-IC luminaires and Do-Not-Cover luminaires shall be supplied with installation instructions containing the following warning:

**WARNING — THIS LUMINAIRE IS NOT SUITABLE FOR INSTALLATION IN LOCATIONS WHERE THERMAL INSULATION IS PRESENT, OR MAY REASONABLY BE EXPECTED TO BE INSTALLED IN THE FUTURE, OR WHERE THERE IS A LIKELIHOOD OF OTHER COMBUSTIBLE MATERIAL, E.G. LEAVES OR VERMIN DEBRIS, ETC. COLLECTING ON OR AROUND THE LUMINAIRE. IT IS NOT SUITABLE FOR DOMESTIC INSTALLATIONS OR INSTALLATION IN RESIDENTIAL AREAS OF NON-DOMESTIC INSTALLATIONS (RESIDENTIAL INSTITUTIONS, HOTELS, BOARDING HOUSES, HOSPITALS, ACCOMMODATION HOUSES, MOTELS, HOSTELS AND THE LIKE).**

### 2.6.105 Luminaires intended for use with independent controlgear

For luminaires intended for use with independent controlgear, pictorial diagrams showing all dimensions for safe installation of the independent controlgear shall be included in the installation instructions.

For luminaires not supplied with, but intended for use with, independent controlgear, the instructions supplied with the recessed luminaire shall specify the brand(s) and model(s) of independent controlgear that may be used.

For luminaires that may be used with supplied independent controlgear or other independent controlgear, the instructions supplied with the recessed luminaire shall specify the brand(s) and model(s) of any other independent controlgear that may be used.

The information on brand(s) and model(s) shall be in the instructions supplied with the luminaire or on a website referenced in the instructions supplied with the luminaire.

### 2.6.106 Compliance

Compliance with Clauses 2.6.101 to 2.6.105 is checked by inspection and the relevant tests of AS/NZS 60598.1.

## 2.7

*Delete* existing text and *replace* with the following:

### 2.7.101 General

The provisions of Section 4 of AS/NZS 60598.1 apply, along with the following.

### 2.7.102 Thermal protection devices

Thermal protection devices that operate to enable the luminaire to comply with the requirements of this Standard shall be integral to, or permanently attached immediately adjacent to, the luminaire light source enclosure. Thermal protection devices that operate to enable the luminaire to comply with the requirements of this Standard shall not be separate devices or in independent controlgear.

NOTE Thermal protection devices are also known as 'thermal cut-outs'.

Single operation non-self-resetting thermal protection devices that are user replaceable are not permitted.

Electronic controls that regulate the light output during abnormal operation tests to enable the luminaire to comply with the requirements of this Standard shall comply with Clause 2.7.103.

Thermal protection devices, excluding electronic controls complying with Clause 2.7.103, that operate to enable the luminaire to comply with requirements of this Standard shall comply with IEC 60730-1, in conjunction with the relevant part of the IEC 60730-2 series.

The number of cycles of operation declared in accordance with IEC 60730-1:2013 (see Clause 6.10 and 6.11 of that Standard) shall not be less than the following:

a)	Self-resetting thermal protection device	10 000
b)	Voltage maintained non-self-resetting thermal protection device	1 000
c)	Other non-self-resetting thermal protection device	30

### 2.7.103 Electronic controls

The operation, or malfunction, of electronic controls that are used to regulate the operation of the light source to enable the luminaire to comply with requirements of this Standard (either during normal or abnormal operation) shall not result in a safety hazard.

Such electronic controls are required to comply with a), b), c) or d) below:

- a) Electronic controls that operate during any test of this Standard and fully turn off the light source shall incorporate the operation of a thermal protection device component that complies with IEC 60730-1 with the number of cycles of operation declared in accordance with Clause 2.7.102.
- b) Electronic controls that operate during any test of this Standard and do not fully turn off the light source shall be bypassed and the relevant test shall be repeated. The luminaire shall comply with the requirements of the relevant test with the electronic control bypassed and any remaining device that operates shall comply with IEC 60730-1 with the number of cycles of operation declared in accordance with Clause 2.7.102.

NOTE This does not mean that any device has to operate to enable compliance with the relevant test.

- c) Electronic controls shall comply with the appropriate part of the AS/NZS 61347 series and incorporate a thermal protective device that has been tested to the number of cycles of operation declared in accordance with Clause 2.7.102.
- d) Electronic controls with programmable components (including embedded software) shall comply with IEC 62733, unless the luminaire complies with the requirements of this Standard with the electronic controls bypassed.

### 2.7.104 Controlgear

All controlgear (including controlgear that is a component part and all independent controlgear) that is supplied with, or specified in, the instructions supplied with the luminaire for use with the luminaire shall be assessed with the luminaire to this Standard and shall, in addition, comply with the appropriate part of the AS/NZS 61347 series.

## 2.13

*Delete* existing text and *replace* with the following:

### 2.13.101 General

The provisions of Section 12 of AS/NZS 60598.1 apply together with the requirements of this Clause (Clause 2.13).

Clause 12.4 and 12.5 of AS/NZS 60598.1 are applied in conjunction with the following:

- a) For Non-IC and Do-not-cover luminaires, the requirements of Clauses 12.4 and 12.5 of AS/NZS 60598.1 are modified by Clause 2.13.102.
- b) For CA90 and CA135 luminaires, the requirements of Clauses 12.4 and 12.5 of AS/NZS 60598.1 are modified by Clause 2.13.103.
- c) For IC and IC-4 luminaires, the requirements of Clauses 12.4 and 12.5 of AS/NZS 60598.1 are modified by Clause 2.13.104.

### **2.13.102 Thermal tests for Non-IC and Do-not-cover luminaires**

#### **2.13.102.1 Normal operation test for Non-IC and Do-not-cover luminaires**

Non-IC and Do-not-cover luminaires shall be tested in accordance with the requirements of Paragraph ZA3 in Appendix ZA.

When the luminaire is tested in accordance with Paragraph ZA3, no temperature shall exceed—

- a) 90 °C on the luminaire mounting surface, or on any of the internal surfaces of the side and top of the test box, or on the surface of any building element installed in accordance with the manufacturer's instructions;
- b) for Do-not-cover luminaires only—90 °C on the surface of any simulated building element or insulation; and
- c) for other parts, the appropriate values given in Tables 12.1 and 12.2 of AS/NZS 60598.1.

There shall be no damage to the luminaire such as scorching, deformation or melting. During the test, no thermal protection device or electronic control that fully turns off the light source within the luminaire or independent controlgear shall operate.

#### **2.13.102.2 Abnormal operation test for Do-not-cover luminaires**

Do-not-cover luminaires shall be tested in accordance with the requirements of Paragraph ZA5.

When the luminaire is tested in accordance with Paragraph ZA5, no temperature shall exceed—

- a) 90 °C on the luminaire mounting surface; and
- b) 130 °C on the surface of insulation.

There shall be no damage to the luminaire such as scorching, deformation or melting. During the test, thermal protective devices or electronic controls within the luminaire may operate, however, the thermal protection devices of any independent controlgear shall not operate to limit temperatures.

### **2.13.103 Thermal tests for CA90 and CA135 luminaires**

#### **2.13.103.1 Normal operation test for CA90 and CA135 luminaires**

CA90 and CA135 luminaires shall be tested in accordance with the requirements of Paragraph ZA4.

When the luminaire is tested in accordance with Paragraph ZA4, no temperature shall exceed—

- a) 90 °C on the luminaire mounting surface, or on any of the internal surfaces of the side and top of the test box, or on the surface of any building element installed in accordance with the manufacturer's instructions;
- b) for CA90 luminaires—90 °C on the outside surface of the luminaire accessible to the relevant test probe of Clause 2.14;
- c) for CA135 luminaires—135 °C on the outside surface of the luminaire accessible to the relevant test probe of Clause 2.14; and
- d) for other parts, the appropriate values given in Tables 12.1 and 12.2 of AS/NZS 60598.1.

There shall be no damage to the luminaire such as scorching, deformation or melting. During the test, no thermal protection device or electronic control that fully turns off the light source within the luminaire or independent controlgear shall operate.

#### **2.13.103.2 Abnormal operation test for CA90 and CA135 luminaires**

CA90 and CA135 luminaires shall be tested in accordance with the requirements of Paragraph ZA5.

When the luminaire is tested in accordance with Paragraph ZA5, no temperature shall exceed—

- a) 90 °C on the luminaire mounting surface;
- b) for CA90 luminaires—130 °C on the outside surface of the luminaire accessible to the relevant test probe of Clause 2.14; and
- c) for CA135 luminaires—150 °C on the outside surface of the luminaire accessible to the relevant test probe of Clause 2.14.

There shall be no damage to the luminaire such as scorching, deformation or melting. During the test, thermal protection devices or electronic controls within the luminaire may operate, however, the thermal protection devices of any independent controlgear shall not operate to limit temperatures.

#### **2.13.104 Thermal tests for IC and IC-4 luminaires**

IC and IC-4 luminaires shall be tested in accordance with the requirements of Paragraph ZA6.

When the luminaire is tested in accordance with Paragraph ZA6, no temperature shall exceed—

- a) 90 °C on the luminaire mounting surface;
- b) 90 °C on the outside surface of the luminaire accessible to the relevant test probe of Clause 2.14; and
- c) for other parts, the appropriate values given in Tables 12.1 and 12.2 of AS/NZS 60598.1.

There shall be no damage to the luminaire such as scorching, deformation or melting. During the test, no thermal protection device, or electronic control that fully turns off the light source, within the luminaire or independent controlgear shall operate.

### **2.14**

*Delete* existing text and *replace* with the following:

#### **2.14.101 General**

The provisions of Section 9 of AS/NZS 60598.1 apply, along with the following.

For luminaires with an IP classification greater than IP20, and for CA90, CA135, IC and IC-4 luminaires, the order of the tests specified in Section 9 of AS/NZS 60598.1 shall be as specified in Clause 2.3 of this Standard.

#### **2.14.102 Ingress test for CA90 and IC luminaires**

Solid foreign objects shall have limited access to the hot surfaces of CA90 and IC luminaires.

Test probe 19 of IEC 61032 shall be applied without appreciable force to all external surfaces and any opening of the luminaire. Test probe 19 shall not be applied to the access face.



The 5.6 mm diameter of the probe shall not enter into an area where the temperature of any surface (including parts of the luminaire or the lamp) exceeds the temperature limit for 'mounting surface: normally flammable surface' of AS/NZS 60598.1, when the surface is measured while the luminaire is operated in accordance with the thermal test conditions of Paragraph ZA4 for CA90 luminaires and Paragraph ZA6 for IC luminaires.

#### **2.14.103 Ingress test for CA135 luminaires—New Zealand only**

**2.14.103.1** Solid foreign objects shall have some access to the hot surfaces of CA135 luminaires.

Compliance is verified in accordance with Clauses 2.14.103.2 and 2.14.103.3.

**2.14.103.2** Test probe 1 of IEC 61032 shall be applied without appreciable force to all external surfaces and any opening of the luminaire. Test probe 1 is not applied to the access face.

The 50 mm diameter of the probe shall not enter into an area where the temperature of any surface (including parts of the luminaire or the lamp) exceeds a value of 135 °C, when the surface is measured while the luminaire is operated in accordance with the thermal test conditions of Paragraph ZA4.

**2.14.103.3** The total area of all openings in the luminaire body that allows airflow through the luminaire (i.e. airflow between the ceiling/wall space and the illuminated area), excluding openings in the access face, shall be no more than 5 % of the area of the opening in the mounting surface (opening in mounting surface as required by the manufacturer to insert the luminaire).

#### **2.14.104 Ingress test for IC-4 luminaires**

Solid foreign objects shall have restricted access to the hot surfaces of IC-4 luminaires and restricted access to the open area that allows airflow through the luminaire (i.e. between the area that the body of the luminaire is located in and the area that the light source illuminates).

The IP4X probes of AS 60529 shall be applied to the complete luminaire and any opening of the luminaire including the access face.

The IP4X probes of AS 60529 shall be applied without appreciable force and shall not enter any area of the luminaire where the temperature of any surface (including parts of the luminaire or the lamp) exceeds the temperature limit for 'mounting surface: normally flammable surface' of AS/NZS 60598.1, when the surface is measured while the luminaire is operated in accordance with the thermal test conditions of Paragraph ZA6.

With the luminaire installed in accordance with the manufacturer's instructions, the IP4X probes of AS 60529 shall not be able to pass from the illuminated area into the area where the body of the luminaire is situated.

## **Appendix**

### **ZZ**

After Appendix ZZ, *add* new Appendices ZA, ZB, ZC and ZD.

APPENDIX ZA  
THERMAL TEST PROCEDURES FOR RECESSED LUMINAIRES  
(Normative)

**ZA1 GENERAL**

For the purposes of this Appendix, the requirements of Clause 12 of AS/NZS 60598.1 apply, with the following modifications and additions:

- (a) A luminaire with a filament light source is energized at 1.05 times the rated wattage. Luminaires with other light sources are energized at 0.94 or 1.06 times the rated voltage, whichever produces higher temperatures.
- (b) Light sources controlled by independent controlgear have this gear energized at 0.94 or 1.06 times the rated voltage, whichever produces higher temperatures.
- (c) The test is run until temperatures have stabilized or 8 h have elapsed.
- (d) The test box shall be positioned in a draught-proof thermal room at a temperature of  $25\text{ °C} \pm 5\text{ °C}$ , or at the  $t_a$  rating of the luminaire  $\pm 5\text{ °C}$ , if the luminaire is marked with a  $t_a$  rating, whichever is the greater.
- (e) Any luminaire independent controlgear shall be installed in accordance with the installation instructions.
- (f) Where a recessed luminaire consists of a light source part supplied with another separate component part (for example, a driver or ballast or control device) connected by an interconnecting cord, then additional tests may be required so as to ensure the highest temperatures for all parts during all tests have been obtained.

Such combinations of tests may include, but are not limited to, the following:

- (i) the separate component part placed under insulation in the test box;
  - (ii) the separate component part placed on insulation in the test box;
  - (iii) the separate component part placed above insulation in the test box;
  - (iv) the separate component part placed outside the test box (where the tests involve the test box being filled with insulation).
- (g) If the instructions for installation indicate that multiple building elements or thermal insulation, or both, may be installed, the tests are conducted with the worst case combination of either building elements or thermal insulation, or both, in place. This may require multiple tests to be conducted.

NOTE: It is intended that recessed luminaires be tested for normal operation in accordance with this Standard in conjunction with the requirements of AS/NZS 60598.1. It is not intended that separate normal operation tests for this Standard and AS/NZS 60598.1 be conducted.

Temperature measurements are conducted in accordance with Annex K of AS/NZS 60598.1 on the hottest points.

NOTE: To enable the tests of Clause 2.16 to be properly conducted, the temperatures of insulating material referred to in Clause 2.16 are required to be measured during these tests of Clause 12.

## ZA2 TEST BOX

A test box, consisting of a mounting surface on top of which is a rectangular box with vertical sides and a top, shall be constructed in accordance with the following:

- The mounting surface shall be made of 15–20 mm thick porous wood fibre board.
- The vertical sides and top of the test box shall be made of 15–20 mm thick porous wood fibre board.
- The dimensions of the test box shall be 450 mm wide × 450 mm long × 300 mm high.
- The minimum horizontal distance from the side of the luminaire to the side of the test box shall be 75 mm and the minimum vertical distance from the top of the luminaire to the underside of the test box top shall be 75 mm.
- Where these side and vertical distances cannot be met due the size of the luminaire, the test box dimensions may be increased the minimum amount necessary to meet the 75 mm clearance dimensions.
- The internal surfaces shall be painted matt black.

For the tests, the test box shall be supported or suspended in a draught-proof enclosure in accordance with AS/NZS 60598.1, Annex D.

Refer to Figure ZA1.

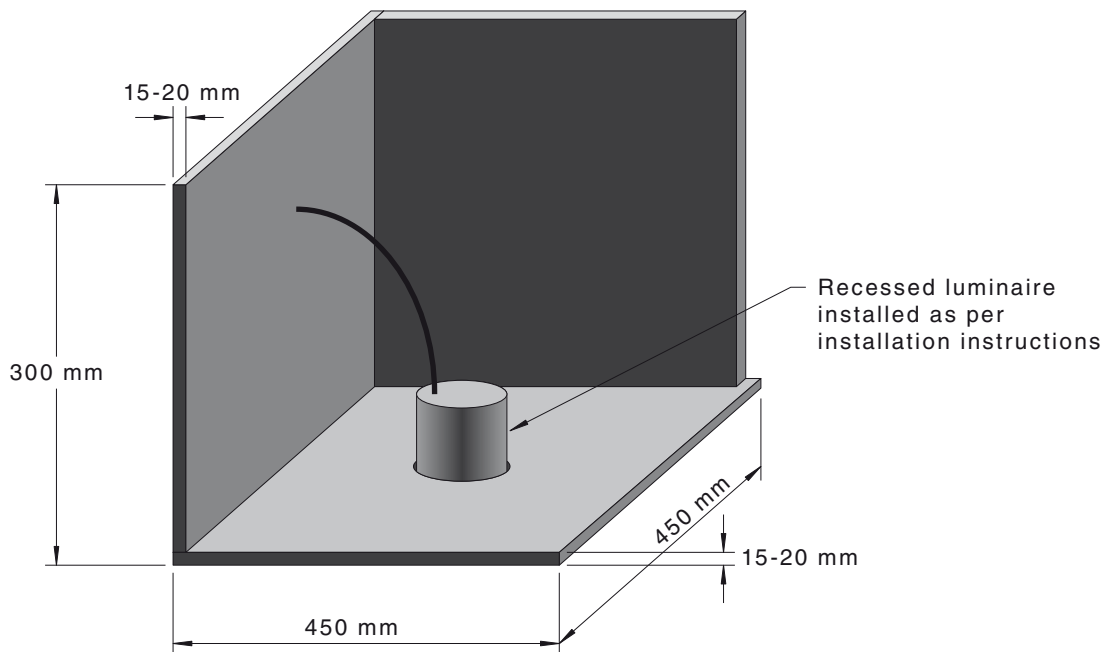

FIGURE ZA1 TEST BOX  
(WITH FRONT, SIDE AND TOP REMOVED)

## ZA3 TEST PROCEDURE FOR NON-IC AND DO-NOT-COVER LUMINAIRES

### ZA3.1 General

This procedure includes assessing the suitable proximity of—

- Non-IC and Do-not-cover luminaires to normally flammable building elements; and
- Do-not-cover luminaires to any thermal insulation specified by the manufacturer in the installation instructions (see Clause 2.6.104).

## ZA3.2 Test set-up

### ZA3.2.1 General

The luminaire under test is placed in the centre of the test box, as shown in Figure ZA1.

If the installation instructions specify clearances from normally flammable building elements, then a simulated building element of nominal dimensions 150 mm × 40 mm is added to the test box at the clearance from the luminaire specified in the manufacturer's instructions, as shown in Figure ZA2.

The simulated building element is constructed of porous wood fibreboard pieces, placed together to create the correct thickness and painted matt black.

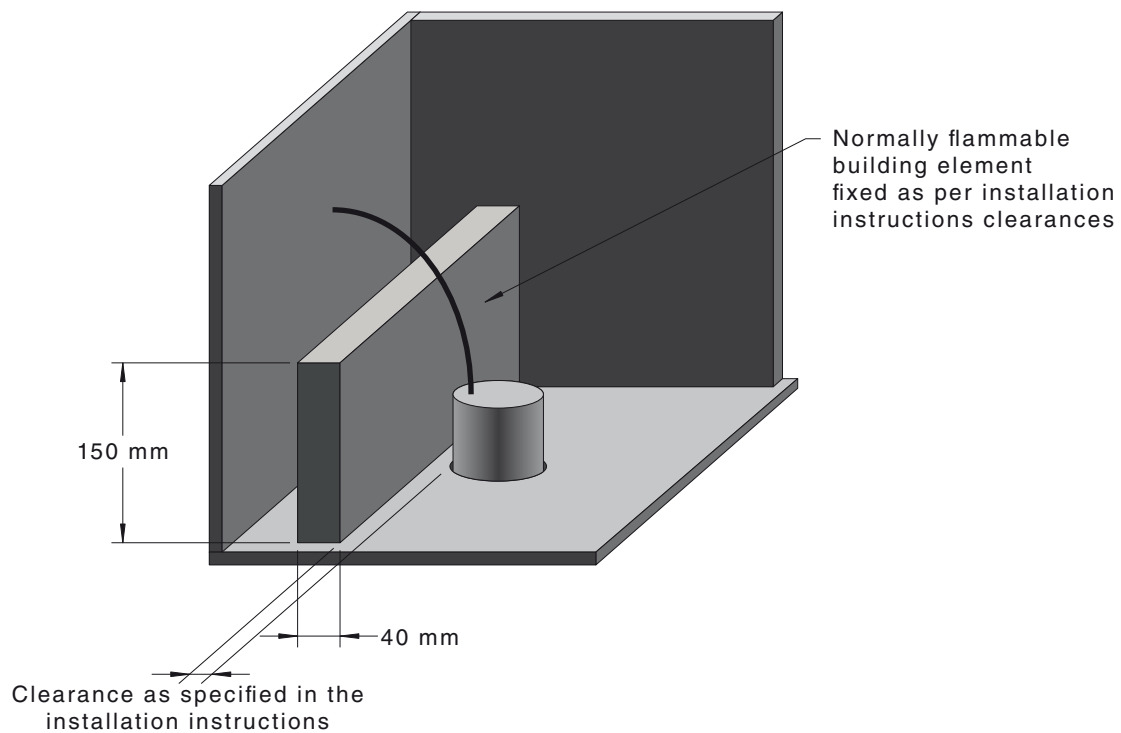

FIGURE ZA2 TEST BOX WITH SIMULATED BUILDING ELEMENT  
(WITH FRONT, SIDE AND TOP REMOVED)

If the installation instructions specify a distance from the top of the luminaire to any building element that is less than the clearance to the top of the test box, then a false ceiling shall be added to the test box at the clearance from the luminaire specified in the manufacturer's instructions, as shown in Figure ZA3.

The false ceiling shall be made of same material as the test box.

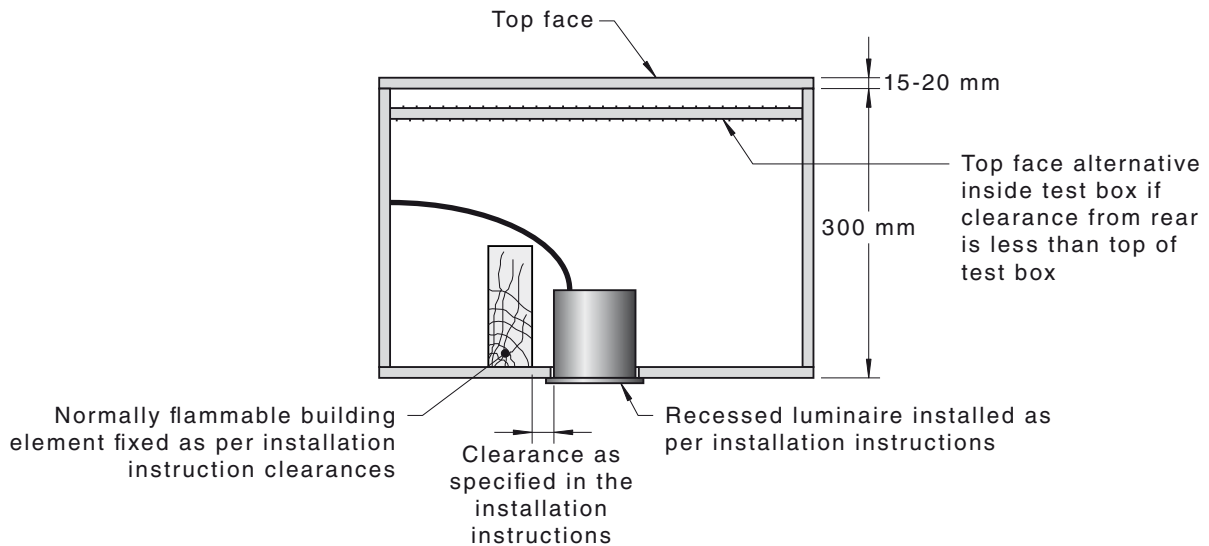

FIGURE ZA3 TEST BOX WITH FALSE CEILING TO MANUFACTURER’S INSTRUCTIONS

**ZA3.2.2** *Non-IC luminaires*

For Non-IC luminaires, the test box specified in Paragraph ZA2 shall be used with the dimensions specified in Paragraph ZA2 or the dimensions stated in the manufacturer’s instructions, whichever gives the smaller clearances.

**ZA3.2.3** *Do-not-cover luminaires*

For Do-not-cover luminaires, the test box specified in Paragraph ZA2 shall be used with the dimensions specified in Paragraph ZA2 or the dimensions stated in the manufacturer’s instructions, whichever gives the smaller clearances.

Thermal insulation to a height of 200 mm is added to the test box with the clearance specified in the installation instructions maintained from the luminaire. The type of thermal insulation is formed insulation where 200 mm is equivalent to an RI 4.0 classification in accordance with AS/NZS 4859.1.

The test set-up shall have the thermocouples attached in the most unfavourable positions.

The test box shall have its top added and sealed.

The test set-up is shown in Figure ZA4.

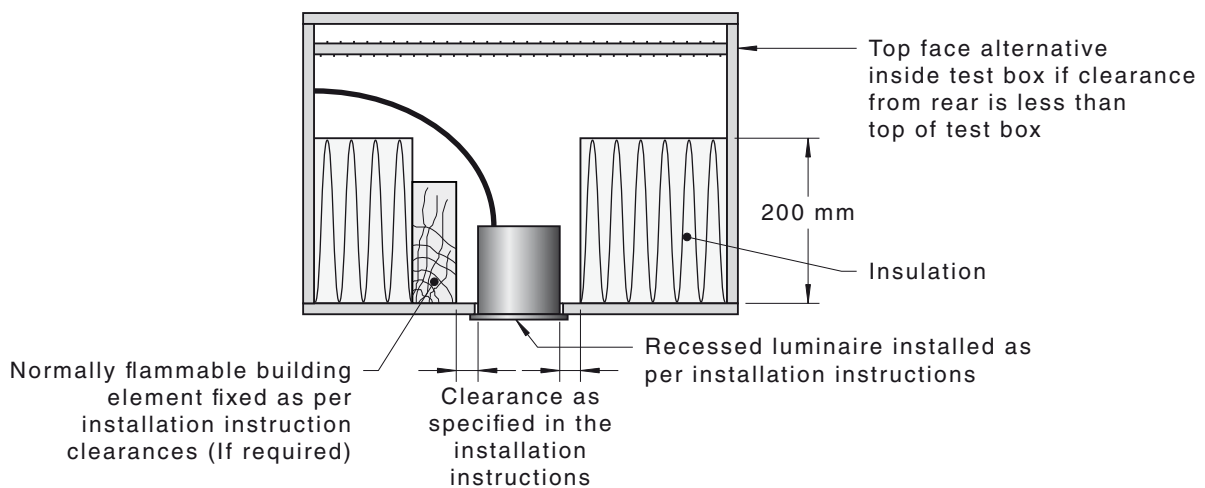

FIGURE ZA4 TEST SET-UP FOR DO-NOT-COVER LUMINAIRES

#### ZA3.2.4 Test requirements and procedure

The testing requirements and procedure shall be in accordance with Paragraph ZA1.

### ZA4 TEST PROCEDURE FOR CA90 AND CA135 LUMINAIRES

#### ZA4.1 General

This test procedure is for CA90 and CA135 luminaires, for assessing the suitability of the luminaire to abut normally flammable materials, as specified in the installation instructions.

#### ZA4.2 Test set-up

The luminaire under test is placed in the centre of the test box as shown in Figure ZA1.

If the installation instructions indicate that the luminaire can abut normally flammable building elements, then a simulated building element, the same as that specified in Paragraph ZA3.2, is added to the test box to abut the luminaire, as shown in Figure ZA2.

If the instructions for installation indicate a distance from the top of the luminaire to any building element that is less than the distance from the top of the luminaire to the top of the test box, then the top of the test box is lowered or a false ceiling of the same material as the test box is placed inside at the required distance.

Thermal insulation to a height of 200 mm is then added to the test box, placed so as to fill the remaining space between the side of the test box and the luminaire, and to abut the sides of the luminaire. The insulation is pushed around the luminaire to form a close fit to the sides of the luminaire without compression. The type of thermal insulation is formed insulation where 200 mm is equivalent to an RI 4.0 classification in accordance with AS/NZS 4859.1.

The test set-up shall have thermocouples attached in the most unfavourable positions.

The test box shall have its top added and sealed.

The test set-up is shown in Figure ZA5.

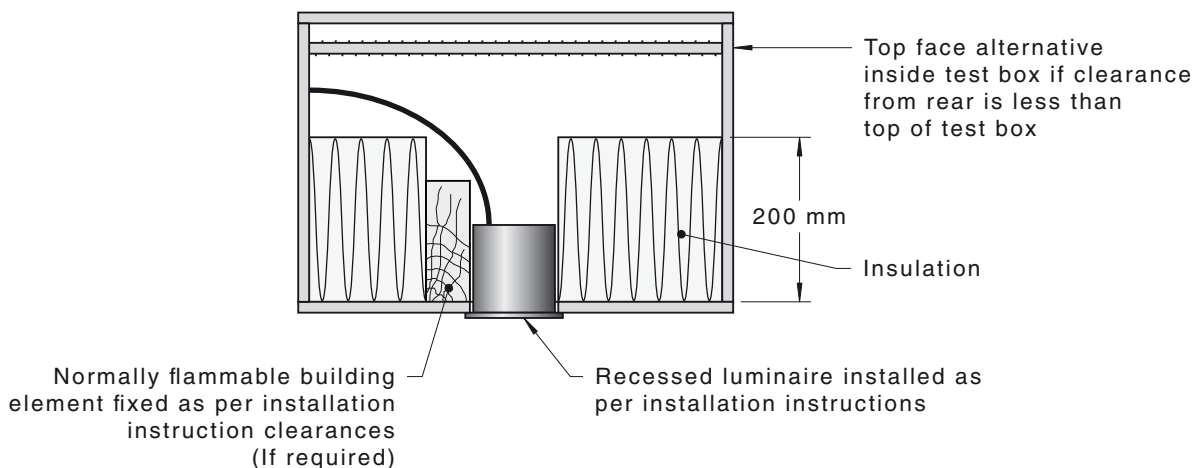

FIGURE ZA5 TEST SET-UP FOR CA90 AND CA135 LUMINAIRES

#### ZA4.3 Test requirements and procedure

The testing requirements and procedure shall be in accordance with Paragraph ZA1.

## ZA5 TEST PROCEDURE FOR ABNORMAL OPERATION—DO-NOT COVER, CA90 AND CA135 LUMINAIRES

### ZA5.1 General

This test procedure is for Do-not-cover, CA90 and CA135 luminaires, for assessing the suitability of abnormal operation.

### ZA5.2 Test set-up

The luminaire under test is placed in the centre of the test box as shown in Figure ZA1.

Thermal insulation is then added to the test box to completely fill the test box. The insulation is pushed around the luminaire to form a close fit to the sides and top of the luminaire without compression. The type of thermal insulation is formed insulation where 200 mm is equivalent to an RI 4.0 classification in accordance with AS/NZS 4859.1.

The test set-up shall have thermocouples attached to the luminaire (on accessible surfaces, in accordance with the specified classification and access probe), the luminaire mounting surface, and any thermal insulation in the most unfavourable positions.

NOTE: Simulated building elements do not need to be added for this test set-up, even if manufacturer's instructions indicate distances to building elements, as the thermal insulation fully enclosing the luminaire is considered to be worst case.

The test box shall have its top added and sealed.

The test set-up is shown in Figure ZA6.

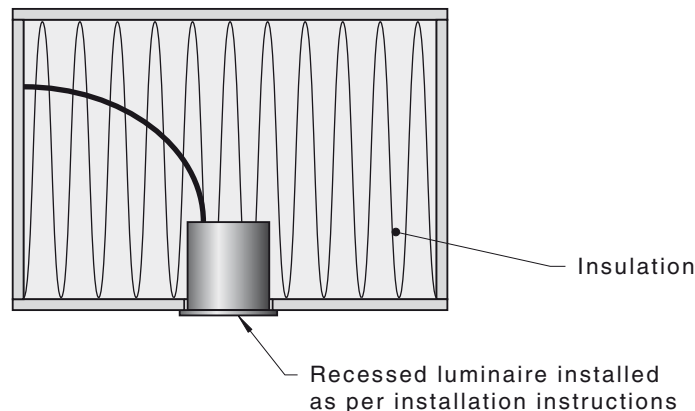

FIGURE ZA6 TEST SET-UP FOR ABNORMAL OPERATION FOR DO-NOT-COVER, CA90 AND CA135 AND NORMAL OPERATION FOR IC AND IC-4 LUMINAIRES

### ZA5.3 Test requirements and procedure

The testing requirements and procedure shall be in accordance with Paragraph ZA1.

## ZA6 TEST PROCEDURE FOR NORMAL OPERATION—IC AND IC-4 LUMINAIRES

### ZA6.1 Test set-up

The luminaire under test is placed in the centre of the test box as shown in Figure ZA1.

Thermal insulation is then added to the test box to completely fill the test box. The insulation is pushed around the luminaire to form a close fit to the sides and top of the luminaire without compression. The type of thermal insulation is formed insulation where 200 mm is equivalent to an RI 4.0 classification in accordance with AS/NZS 4859.1.

The test set-up shall have thermocouples attached to the luminaire (on accessible surfaces, in accordance with the specified classification and access probe), luminaire mounting surface, and any thermal insulation in the most unfavourable positions.

NOTE: Simulated building elements do not need to be added for this test set-up, even if manufacturer's instructions indicate distances to building elements, as the thermal insulation fully enclosing the luminaire is considered to be worst case.

The test box shall have its top added and sealed.

The test set-up is shown in Figure ZA6.

#### **ZA6.2 Test requirements and procedure**

The testing requirements and procedure shall be in accordance with Paragraph ZA1.



## APPENDIX ZB

## EXAMPLES OF METHODS SATISFYING THE REQUIREMENTS FOR THE SUPPLY OF INFORMATION ON MINIMUM CLEARANCE DISTANCES

(Informative)

This Appendix provides examples of methods that satisfy the requirements of Clause 2.6.103 for the supply of information on minimum clearance distances.

These methods are examples only and do not preclude the use of other methods to meet the requirements of Clause 2.6.103.

NOTE: The distances specified in the examples are for illustrative purposes only. The distances at least need to be replaced by the distances determined by test (i.e. the distances in the information supplied may be the distances determined by test, or greater).

Example 1—For Australia and New Zealand:

In this example, where the clearance above the luminaire has been shown by test to be at least 40 mm, and the clearance from each side of the luminaire has been shown by test to be at least 25 mm, the information in the instructions could be worded as follows:

- (a) The minimum distance from the top of the luminaire to any normally flammable building element is 40 mm.
- (b) The minimum distance from the top of the luminaire to any building insulation is 40 mm.
- (c) The minimum distance from the side of the luminaire to any normally flammable building element is 25 mm.
- (d) The minimum distance from the side of the luminaire to any building insulation is 25 mm.

Example 2—For New Zealand:

NOTE: This example is consistent with requirements for New Zealand in AS/NZS 3000, *Electrical installations (known as the Australian/New Zealand Wiring Rules)*, but may not be consistent with requirements for Australia in AS/NZS 3000.

In this example, the installation instructions would first explain the abbreviations being used for the minimum clearance distances as follows:

- (i) HCB (Height clearance to building element)  
Minimum distance as specified by the luminaire manufacturer between the top of the recessed luminaire and any building element above it.
- (ii) MIC (Minimum insulation clearance)  
Minimum distance as specified by the luminaire manufacturer between the top of the recessed luminaire and the building insulation above it.
- (iii) SCB (Side clearance to building element)  
Minimum distance between the side of the recessed luminaire and any building element as specified in AS/NZS 3000, or as specified by the luminaire manufacturer.
- (iv) SCI (Side clearance to insulation)  
Minimum distance as specified by the luminaire manufacturer between the recessed luminaire and any building insulation.

The information on minimum clearance distances could then be provided in the instructions, with a warning, as shown in the various examples below:

**RISK OF FIRE — REQUIRED CLEARANCE FROM STRUCTURAL MEMBERS AND BUILDING ELEMENTS**

HCB = 20 mm MIC = 10 mm SCB = 15 mm SCI = 20 mm

Example of the words provided in a table format:

<p><b>RISK OF FIRE — REQUIRED CLEARANCE FROM STRUCTURAL MEMBERS AND BUILDING ELEMENTS</b></p> <p>HCB = 20 mm MIC = 10 mm SCB = 15 mm SCI = 20 mm</p>
--

For Do-not-cover luminaires, the warning could be modified as follows:

**RISK OF FIRE — BUILDING INSULATION MUST NOT COVER THIS LUMINAIRE**

HCB = 20 mm MIC = 10 mm SCB = 15 mm SCI = 20 mm

Example of the words provided in a table format:

<p><b>RISK OF FIRE — BUILDING INSULATION MUST NOT COVER THIS LUMINAIRE</b></p> <p>HCB = 20 mm MIC = 10 mm SCB = 15 mm SCI = 20 mm</p>
---

For Non-IC luminaires, the warning could be as follows:

**DANGER — RISK OF FIRE**

– Shall not be installed in domestic premises.

HCB = 20 mm MIC = 10 mm SCB = 15 mm SCI = 20 mm

Example of the words provided in a table format:

<p><b>DANGER — RISK OF FIRE</b></p> <p><b>– SHALL NOT BE INSTALLED IN DOMESTIC PREMISES</b></p> <p>HCB = 20 mm MIC = 10 mm SCB = 15 mm SCI = 20 mm</p>
--

APPENDIX ZC  
 EXAMPLES OF RECESSED LUMINAIRES  
 (Informative)

Figure ZC1 shows the general parts of a recessed luminaire. Figures ZC2 to ZC7 show various recessed luminaire configurations.

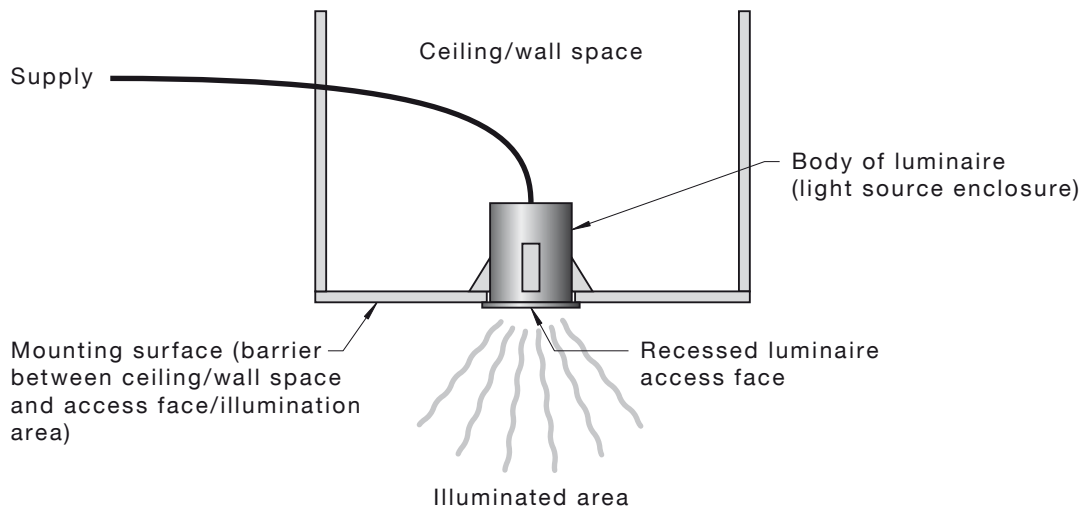

FIGURE ZC1 GENERAL PARTS OF A RECESSED LUMINAIRE

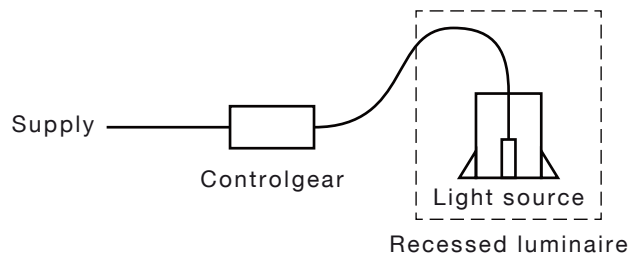

FIGURE ZC2 RECESSED LUMINAIRE WITH INDEPENDENT CONTROLGEAR (CONTROLGEAR NOT SUPPLIED WITH LUMINAIRE)

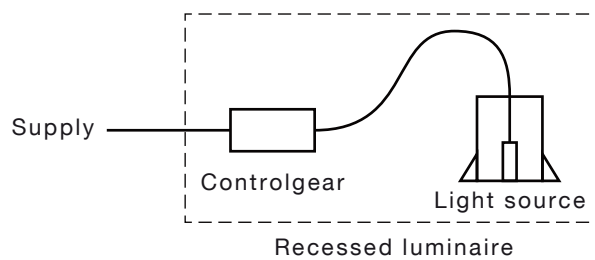
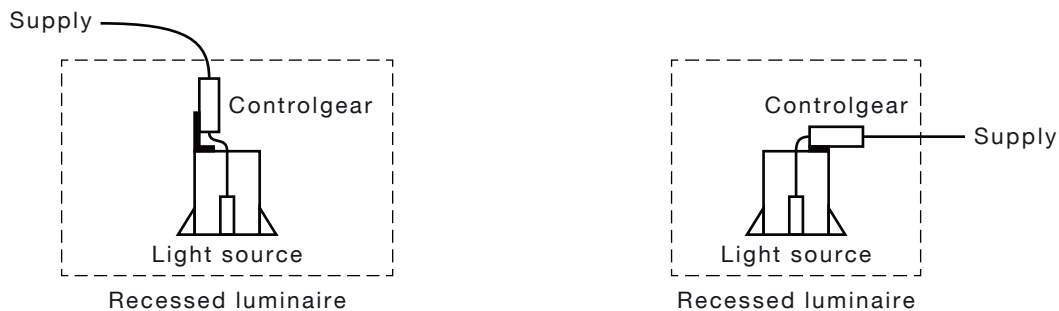

FIGURE ZC3 RECESSED LUMINAIRE WITH SUPPLIED COMPONENT PART CONTROLGEAR CONNECTED BY INTERCONNECTING CORD TO LIGHT SOURCE

<http://www.china-gauges.com/>



NOTES:

- 1 These luminaires may also be supplied without the controlgear part (and so use independent controlgear), however, for compliance with this Standard, the controlgear specified by the manufacturer of the light source part has to be used and treated as a component.
- 2 These figures show examples of two different orientations of mounting the controlgear attached to the luminaire.

FIGURE ZC4 RECESSED LUMINAIRE WITH SUPPLIED COMPONENT PART CONTROLGEAR PHYSICALLY ATTACHED TO LIGHT SOURCE

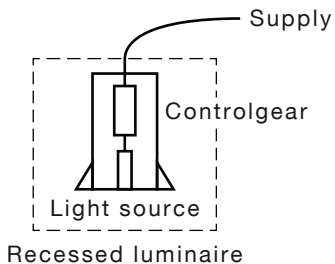

FIGURE ZC5 RECESSED LUMINAIRE WITH SUPPLIED COMPONENT PART CONTROLGEAR WITHIN ENCLOSURE OF LIGHT SOURCE

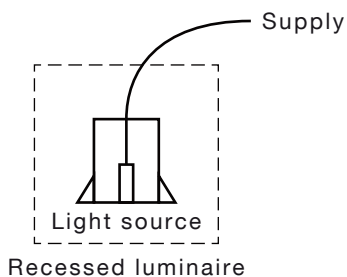
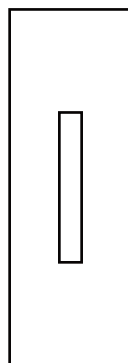
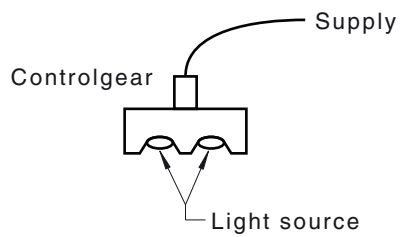

FIGURE ZC6 RECESSED LUMINAIRE NOT RELIANT ON ANY CONTROLGEAR



TOP VIEW



SIDE VIEW

FIGURE ZC7 RECESSED LUMINAIRE—TROFFER

APPENDIX ZD  
GUIDANCE ON CLASSIFICATIONS  
(Informative)

This Appendix provides information and guidance on the classifications, symbols, applications and general restrictions on recessed luminaires.

**TABLE ZD1**  
**GUIDE TO RECESSED LUMINAIRE CLASSIFICATION, SYMBOLS, APPLICATION AND GENERAL RESTRICTIONS ON USE**

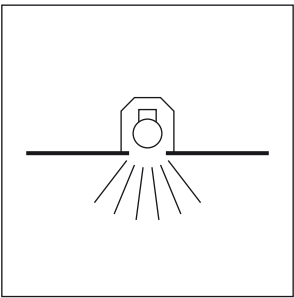
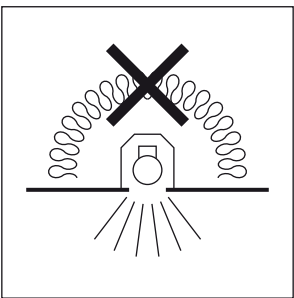
Type	Symbol	Abutted*	Normal use†—Covered	Use with insulation‡	Accessibility to high temperature parts§	Surface of luminaire normal operating temperature limit	Comments
<b>Non-IC</b>		No	No	No	Fully accessible	No limit on side or top surface of luminaire Mounting surface of luminaire limited to 90°C	Suitable for use in Australia and New Zealand—Intended for commercial industrial use only. Not for residential use. Not for use in residential dwellings or other places where building insulation may be installed (now or in the future). These luminaires have not been tested for use with building insulation.
<b>Do-Not-Cover</b>		No	No	Yes	Fully accessible	No limit on side or top surface of luminaire Mounting surface of luminaire limited to 90°C	Currently prohibited from installation in residential locations in New Zealand by AS/NZS 3000. Suitable for residential or commercial use in Australia. Cannot be covered. Manufacturer's stated clearance distances from sides of luminaire to insulation, and clearance above luminaire, will be in the installation instructions supplied with the luminaire, indicating clearances have to be observed at all times for correct installation. These luminaires have been tested to show that they are for use with building insulation present, observing manufacturer's stated installation clearance distances. They cannot be covered with building insulation, however, they have been tested to show that if inadvertently covered they should not become a fire hazard.

(continued)

TABLE ZD1 (continued)

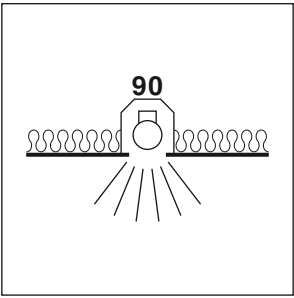
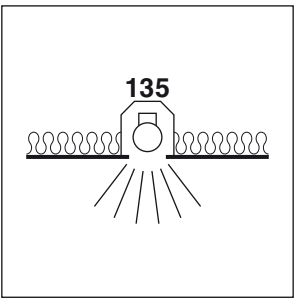
Type	Symbol	Abutted*	Normal use†—Covered	Use with insulation‡	Accessibility to high temperature parts§	Surface of luminaire normal operating temperature limit	Comments
CA90		Yes	No	Yes	<b>Limited access</b> In this Standard, this is assessed for access to high temperature parts by use of a 5.6 mm probe to side and top of luminaire	90°C limit on side or top or mounting surface of luminaire	Suitable for residential or commercial use in Australia and New Zealand. Cannot be covered. Insulation can be placed against the sides of the luminaire. Manufacturer's stated clearance above the luminaire will be in the instructions provided with the luminaire, indicating clearance has to be observed for correct installation. These luminaires have been tested to show that they are for use with building insulation present and placed against the sides of the luminaire. They cannot be covered in building insulation, however, they have been tested to show that if inadvertently covered they should not become a fire hazard.
CA135		Yes	No	Yes	<b>Some access</b> In this Standard, this is assessed for access to high temperature parts by use of a 50 mm probe to side and top of luminaire	135°C limit on side or top surface of luminaire Mounting surface of luminaire limited to 90°C	Suitable for residential or commercial use in New Zealand only. Not permitted for use in Australia. Cannot be covered. Insulation can be placed against the sides of the luminaire. Manufacturer's stated clearance above the luminaire will be in the instructions provided with the luminaire, indicating clearance has to be observed for correct installation. Cannot be used where building materials or insulation is not rated for exposure to constant temperatures of 135°C (cannot have such building material or insulation touching the sides of the luminaire). These luminaires have been tested to show that they are for use with building insulation present and placed against the sides of the luminaire. They cannot be covered in building insulation, however, have been tested to show that if inadvertently covered they should not become a fire hazard.

(continued)

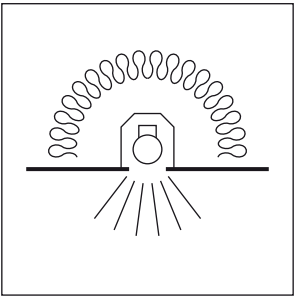
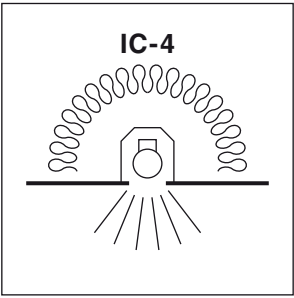

TABLE ZD1 (continued)

Type	Symbol	Abutted*	Normal use†—Covered	Use with insulation‡	Accessibility to high temperature parts§	Surface of luminaire normal operating temperature limit	Comments
IC		Yes	Yes	Yes	<b>Limited access</b> In this Standard, this is assessed for access to high temperature parts by use of a 5.6 mm probe to sides and top of luminaire.	90°C limit on side or top or mounting surface of luminaire	Suitable for residential or commercial use in Australia and New Zealand.  Used where some air transfer is allowed or desired between living space and roof space (there will be some air transfer between the spaces if the luminaire is not fully covered in insulation).  These luminaires have been tested to show they are suitable for normal use when covered in building insulation.
IC-4		Yes	Yes	Yes	<b>Restricted access</b> In this Standard, this is assessed for access to high temperature parts by use of a IP4X—1 mm probe to sides, top and front face of luminaire.	90°C limit on side or top or mounting surface of luminaire	Suitable for residential or commercial use in Australia and New Zealand.  Used where air transfer is not permitted or not desired between living space and roof space (there will be no air transfer between spaces even if there is no insulation covering the luminaire).  Typical use is passive house design where no air transfer is allowed.  These luminaires have been tested to show that they are suitable for normal use when covered in building insulation.

(continued)

TABLE ZD1 (continued)

Type	Symbol	Abutted*	Normal use†—Covered	Use with insulation‡	Accessibility to high temperature parts§	Surface of luminaire normal operating temperature limit	Comments
No Marking		No	No	No	No		<p>Not verified as tested/compliant to Australian/New Zealand standards.</p> <p>Marking is required by standards—no marking indicates non-compliance.</p> <p>Installation instructions specifying any clearance distance is required by this Standard.</p> <p>Do not install any luminaire that does not have one of the marking symbols or instructions specifying any clearance distances.</p> <p>NOTE: For luminaires installed prior to the publication of this Standard (AS/NZS 60598.2.2:2016), which do not have marking and/or installation instructions with clearance distances specified, refer to AS/NZS 3000.</p>

\* May be abutted against normally flammable building elements or insulation.

† Intended and tested for use under building insulation as part of normal operation.

‡ May be used where building insulation may be installed (now or in the future).

§ Classification and probe to determine access of insulation etc., to high temperature parts.

## **Standards Australia**

Standards Australia is an independent company, limited by guarantee, which prepares and publishes most of the voluntary technical and commercial standards used in Australia. These standards are developed through an open process of consultation and consensus, in which all interested parties are invited to participate. Through a Memorandum of Understanding with the Commonwealth government, Standards Australia is recognised as Australia's peak national standards body.

## **Standards New Zealand**

The first national standards organization was created in New Zealand in 1932. The Standards Council of New Zealand is the national authority responsible for the production of standards. Standards New Zealand is the trading arm of the Standards Council established under the Standards Act 1988.

## **Australian/New Zealand Standards**

Under a Memorandum of Understanding between Standards Australia and Standards New Zealand, Australian/New Zealand standards are prepared by committees of experts from industry, governments, consumers, and other sectors. The requirements or recommendations contained in published standards are a consensus of the views of representative interests and also take account of comments received from other sources. They reflect the latest scientific and industry experience. Australian/New Zealand standards are kept under continuous review after publication and are updated regularly to take account of changing technology.

## **International involvement**

Standards Australia and Standards New Zealand are responsible for ensuring that the Australian and New Zealand viewpoints are considered in the formulation of international standards and that the latest international experience is incorporated in national and joint standards. This role is vital in assisting local industry to compete in international markets. Both organisations are the national members of ISO (the International Organization for Standardization) and IEC (the International Electrotechnical Commission).

## **Visit our websites**

[www.standards.org.au](http://www.standards.org.au)

[www.standards.co.nz](http://www.standards.co.nz)

