

SANS 164-5:2007
Edition 1.1

Contents

	Page
Foreword	
1 Scope	3
2 Normative reference	3
3 Definitions	3
4 Requirements	3
Annex A (normative) Gauges for pin diameter	5
Annex B (normative) Gauge for interchangeability	6

SANS 164-5:2007
Edition 1.1

Plug and socket-outlet systems for household and similar purposes for use in South Africa

Part 5:

Two-pole, non-rewirable plugs, 2,5 A 250 V a.c., with cord, for connection of class II equipment

Amdt 1

1 Scope

This part of SANS 164 covers the rating and dimensions of two-pole, non-rewirable plugs, rated at 2,5 A 250 V a.c., for connection of class II equipment for household and similar purposes, for use in South Africa.

Amdt 1

2 Normative reference

The following standard contains provisions which, through reference in this text, constitutes provisions of this part of SANS 164. All standards are subject to revision and, since any reference to a standard is deemed to be a reference to the latest edition of that standard, parties to agreements based on this part of SANS 164 are encouraged to take steps to ensure the use of the most recent edition of the standard indicated below. Information on currently valid national and international standards can be obtained from Standards South Africa.

SANS 164-0, *Plug and socket-outlet systems for household and similar purposes for use in South Africa – Part 0: General and safety requirements.*

3 Definitions

For the purposes of this part of SANS 164, the definitions given in SANS 164-0 apply.

4 Requirements

- 4.1** The requirements of SANS 164-0 apply.
- 4.2** Plugs shall be rated at 2,5 A and 250 V a.c.
- 4.3** Plugs shall be non-rewirable and fitted with a cord.
- 4.4** Plugs shall comply with the dimensions given on standard sheet 5-1.

Use gauges given in annexes A and B for checking the dimensions.

SANS 164-5:2007
Edition 1.1

Dimensions in millimetres

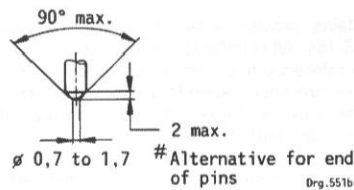
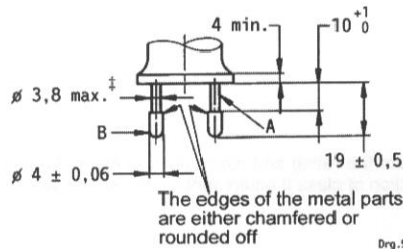
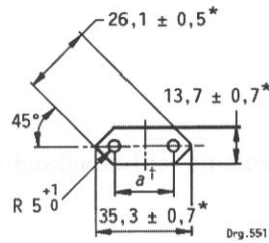

Key

- A Insulating collar
- B Metal pin

NOTE The sketches are not intended to govern design except as regards the dimensions shown.

* These dimensions shall not be exceeded within a distance of 18 mm from the engagement face of the plug.

† Dimension *a* is
18 mm to 19,2 mm in the plane of the engagement face,
17 mm to 18 mm at the ends of the pins.

‡ This dimension may be increased to 4 mm within a distance of 4 mm from the engagement face of the plug.

Pin ends shall be rounded or conical as shown in detailed sketch.

Standard sheet 5-1 — 2,5 A 250 V Two-pole plug for class II equipment

SANS 164-5:2007
Edition 1.1

Annex A
(normative)

Gauges for pin diameter

Dimensions in millimetres

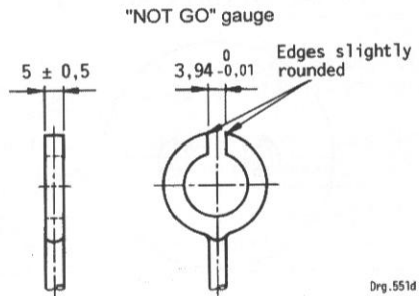
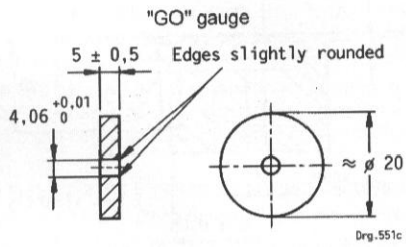

It shall be possible to pass the pin through the "GO" gauge without undue force; it shall not be possible to pass the pin through the gap in the "NOT GO" gauge without undue force.

SANS 164-5:2007
Edition 1.1

Annex B
(normative)

Gauge for interchangeability

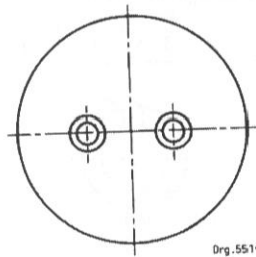
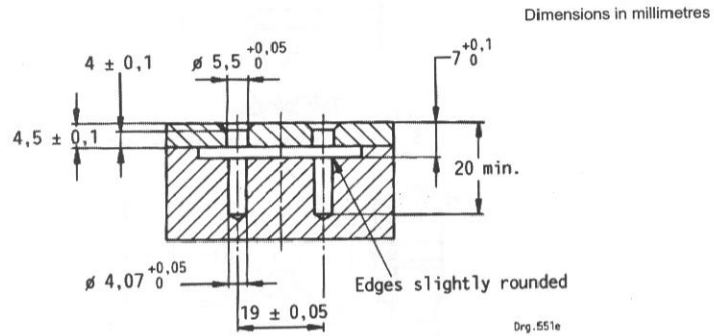

It shall be possible to insert the plug into the gauge without undue force so that the engagement face comes into contact with the surface of the gauge.

© Standards South Africa

ISBN 978-0-626-20853-0

SANS 164-5:2007

Edition 1.1

Table of changes

Change No.	Date	Description
1	2007	Amended to change the title

SOUTH AFRICAN NATIONAL STANDARD

Plug and socket-outlet systems for household and similar purposes for use in South Africa

Part 5: Two-pole, non-rewirable plugs, 2,5 A 250 V a.c., with cord, for connection of class II equipment

Amdt 1

**WARNING — Can only be used
in conjunction with
SANS 164-0.**

Published by Standards South Africa
1 dr Iategan road groenkloof ☒ private bag x191 pretoria 0001
tel: 012 428 7911 fax: 012 344 1568 international code + 27 12
www.stansa.co.za
© Standards South Africa

standards
South Africa
(a division of SABS)