



BSI Standards Publication

Safety requirements for electrical equipment for measurement, control, and laboratory use

Part 2-201: Particular requirements for control equipment

<http://www.china-gauges.com/>

bsi.

National foreword

This British Standard is the UK implementation of EN IEC 61010-2-201:2018. It is identical to IEC 61010-2-201:2017. It supersedes BS EN 61010-2-201:2013, which will be withdrawn on 22 June 2023.

The UK participation in its preparation was entrusted to Technical Committee GEL/65, Measurement and control.

A list of organizations represented on this committee can be obtained on request to its secretary.

This publication does not purport to include all the necessary provisions of a contract. Users are responsible for its correct application.

© The British Standards Institution 2018
Published by BSI Standards Limited 2018

ISBN 978 0 580 89107 6

ICS 19.020; 17.020; 25.040.40; 13.110

Compliance with a British Standard cannot confer immunity from legal obligations.

This British Standard was published under the authority of the Standards Policy and Strategy Committee on 31 July 2018.

Amendments/corrigenda issued since publication

Date	Text affected
------	---------------

<http://www.china-gauges.com/>

EUROPEAN STANDARD

EN IEC 61010-2-201

NORME EUROPÉENNE

EUROPÄISCHE NORM

June 2018

ICS 17.020; 19.020; 25.040.40

Supersedes EN 61010-2-201:2013

English Version

Safety requirements for electrical equipment for measurement,
control, and laboratory use - Part 2-201: Particular requirements
for control equipment
(IEC 61010-2-201:2017)

Exigences de sécurité pour appareils électriques de
mesurage, de régulation et de laboratoire - Partie 2-201:
Exigences particulières pour les équipements de
commande
(IEC 61010-2-201:2017)

Sicherheitsbestimmungen für elektrische Mess-, Steuer-,
Regel- und Laborgeräte - Teil 2-201: Besondere
Anforderungen für Steuer- und Regelgeräte
(IEC 61010-2-201:2017)

This European Standard was approved by CENELEC on 2017-02-20. CENELEC members are bound to comply with the CEN/CENELEC Internal Regulations which stipulate the conditions for giving this European Standard the status of a national standard without any alteration.

Up-to-date lists and bibliographical references concerning such national standards may be obtained on application to the CEN-CENELEC Management Centre or to any CENELEC member.

This European Standard exists in three official versions (English, French, German). A version in any other language made by translation under the responsibility of a CENELEC member into its own language and notified to the CEN-CENELEC Management Centre has the same status as the official versions.

CENELEC members are the national electrotechnical committees of Austria, Belgium, Bulgaria, Croatia, Cyprus, the Czech Republic, Denmark, Estonia, Finland, Former Yugoslav Republic of Macedonia, France, Germany, Greece, Hungary, Iceland, Ireland, Italy, Latvia, Lithuania, Luxembourg, Malta, the Netherlands, Norway, Poland, Portugal, Romania, Serbia, Slovakia, Slovenia, Spain, Sweden, Switzerland, Turkey and the United Kingdom.

<http://www.china-gauges.com/>



European Committee for Electrotechnical Standardization
Comité Européen de Normalisation Electrotechnique
Europäisches Komitee für Elektrotechnische Normung

CEN-CENELEC Management Centre: Rue de la Science 23, B-1040 Brussels

© 2018 CENELEC All rights of exploitation in any form and by any means reserved worldwide for CENELEC Members.

Ref. No. EN IEC 61010-2-201:2018 E

European foreword

The text of document 65/652/FDIS, future edition 2 of IEC 61010-2-201, prepared by IEC/TC 65 "Industrial-process measurement, control and automation" was submitted to the IEC-CENELEC parallel vote and approved by CENELEC as EN IEC 61010-2-201:2018.

The following dates are fixed:

- latest date by which the document has to be implemented at national level by publication of an identical national standard or by endorsement (dop) 2018-12-22
- latest date by which the national standards conflicting with the document have to be withdrawn (dow) 2023-06-22

This document supersedes EN 61010-2-201:2013 and EN 61010-2-201:2013/AC:2013.

Attention is drawn to the possibility that some of the elements of this document may be the subject of patent rights. CENELEC shall not be held responsible for identifying any or all such patent rights.

This document has been prepared under a mandate given to CENELEC by the European Commission and the European Free Trade Association, and supports essential requirements of EU Directives.

For the relationship with EU Directives see informative Annex ZZ, which is integral part of this document.

Endorsement notice

The text of the International Standard IEC 61010-2-201:2017 was approved by CENELEC as a European Standard without any modification.

The Bibliography of EN 61010-1:2010 applies, except as follows:

Addition:

IEC 60079 (series)	NOTE	Harmonized as EN 60079 (series).
IEC 60364 (series)	NOTE	Harmonized as HD 60364 (series).
IEC 60364-4-41	NOTE	Harmonized as HD 60364-4-41.
IEC 60664-5 ¹	NOTE	Harmonized as EN 60664-5 ¹ .
IEC 60715	NOTE	Harmonized as EN 60715.
IEC 60721-2-3	NOTE	Harmonized as EN 60721-2-3. http://www.china-gauges.com/
IEC 61131-2:2007	NOTE	Harmonized as EN 61131-2:2007 (not modified).
IEC 61131-6	NOTE	Harmonized as EN 61131-6.
IEC 61140	NOTE	Harmonized as EN 61140.
IEC 61326 (series)	NOTE	Harmonized as EN 61326 (series).
IEC 61508 (series)	NOTE	Harmonized as EN 61508 (series).
IEC 61643 (series)	NOTE	Harmonized as EN 61643 (series).
IEC 61800 (series)	NOTE	Harmonized as EN 61800 (series).
IEC 62133	NOTE	Harmonized as EN 62133.
IEC 62368 (series)	NOTE	Harmonized as EN 62368 (series).

¹ Withdrawn publication.

Annex ZA
(normative)

**Normative references to international publications
with their corresponding European publications**

The following documents, in whole or in part, are normatively referenced in this document and are indispensable for its application. For dated references, only the edition cited applies. For undated references, the latest edition of the referenced document (including any amendments) applies.

NOTE 1 When an International Publication has been modified by common modifications, indicated by (mod), the relevant EN/HD applies.

NOTE 2 Up-to-date information on the latest versions of the European Standards listed in this annex is available here: www.cenelec.eu

<u>Publication</u>	<u>Year</u>	<u>Title</u>	<u>EN/HD</u>	<u>Year</u>
IEC 60027	series	Letter symbols to be used in electrical	EN 60027	series
IEC 60065 (mod)	-	Audio, video and similar electronic apparatus - Safety requirements	EN 60065	2014
-	-		+ A11	2017
IEC 60068-2-14	-	Environmental testing -- Part 2-14: Tests - Test N: Change of temperature	EN 60068-2-14	2009
IEC 60068-2-75	-	Environmental testing - Part 2-75: Tests - Test Eh: Hammer tests	EN 60068-2-75	2014
IEC 60073	-	Basic and safety principles for man-machine interface, marking and identification - Coding principles for indicators and actuators	EN 60073	2002
IEC 60227	series	Polyvinyl chloride insulated cables of rated - voltages up to and including 450/750	-	-
IEC 60245	series	Rubber insulated cables - Rated voltages up to and including 450/750 V	-	-
IEC 60309	series	Plugs, socket-outlets and couplers for industrial purposes	EN 60309	series
IEC 60320	series	Appliance couplers for household and similar general purposes -	EN 60320	series
IEC 60332-1-2	-	Tests on electric and optical fibre cables under fire conditions -- Part 1-2: Test for vertical flame propagation for a single insulated wire or cable - Procedure for 1 kW pre-mixed flame	EN 60332-1-2	2004
-	-		+ A1	2015
-	-		+ A11	2016
IEC 60332-2-2	-	Tests on electric and optical fibre cables under fire conditions -- Part 2-2: Test for vertical flame propagation for a single small insulated wire or cable - Procedure for diffusion flame	EN 60332-2-2	2004

EN IEC 61010-2-201:2018 (E)

IEC 60335-2-24	-	Household and similar electrical appliances -- Part 2-24: Particular requirements for refrigerating appliances, ice-cream appliances and ice makers	EN 60335-2-24	2010
IEC 60335-2-89	-	Household and similar electrical appliances -- Part 2-89: Particular requirements for commercial refrigerating appliances with an incorporated or remote refrigerant condensing unit or compressor	EN 60335-2-89	2010
-	-		+ A1	2016
-	-		+ A2	2017
IEC 60364-4-44 (mod)	2007	Low-voltage electrical installations -- Part 4-44: Protection for safety - Protection against voltage disturbances and electromagnetic disturbances	HD 60364-4-442 HD 60364-4-444	2012 2010
+ A1 (mod)	2015		HD 60364-4-443	2016
IEC 60384-14	-	Fixed capacitors for use in electronic equipment -- Part 14: Sectional specification - Fixed capacitors for electromagnetic interference suppression and connection to the supply mains	EN 60384-14	2013
IEC 60417	1973 ²	Graphical symbols for use on equipment	-	-
IEC 60529	2013 ²	Degrees of protection provided by enclosures (IP Code)	-	-
IEC 60664-1	-	Insulation coordination for equipment within low-voltage systems -- Part 1: Principles, requirements and tests	EN 60664-1	2007
IEC 60664-3	-	Insulation coordination for equipment within low-voltage systems - Part 3: Use of coating, potting or moulding for protection against pollution	EN 60664-3	2017
IEC 60695-2-11	-	Fire hazard testing - Part 2-11: Glowing/hot-wire based test methods - Glow-wire flammability test method for end-products (GWEPT)	EN 60695-2-11	2014
IEC 60695-11-3	-	Fire hazard testing -- Part 11-3: Test flames - 500 W flames - Apparatus and confirmational test methods	EN 60695-11-3 http://www.china-gauges.com/	2012
IEC 60695-11-10	-	Fire hazard testing -- Part 11-10: Test flames - 50 W horizontal and vertical flame test methods	EN 60695-11-10	2013
IEC 60799	2018 ²	Electrical accessories – Cord sets and interconnection cord sets	-	-
IEC 60825-1	-	Safety of laser products -- Part 1: Equipment classification and requirements	EN 60825-1	2014
-	-		EN 60825-1:2014/AC:2017-06	2017
IEC 60947-1	2007	Low-voltage switchgear and controlgear -- Part 1: General rules	EN 60947-1	2007

² Dated as no equivalent European Standard exists.

-	-		+ A1	2011
-	-		+ A2	2014
IEC 60947-2	-	Low voltage switchgear and controlgear - Part 2: Circuit-breakers	EN 60947-2	2017
IEC 60947-3	-	Low-voltage switchgear and controlgear -- Part 3: Switches, disconnectors, switch-disconnectors and fuse-combination units	EN 60947-3	2009
	-		+ A1	2012
	-		+ A2	2015
IEC 60947-5-1	-	Low-voltage switchgear and controlgear - Part 5-1: Control circuit devices and switching elements - Electromechanical control circuit devices	EN 60947-5-1	2017
IEC 61010-1	2010	Safety requirements for electrical equipment for measurement, control and laboratory use -- Part 1: General requirements	EN 61010-1	2010
IEC 61010-2-030	-	Safety requirements for electrical equipment for measurement, control and laboratory use -- Part 2-030: Particular requirements for testing and measuring circuits	EN 61010-2-030	2010
IEC 61010-031	-	Safety requirements for electrical equipment for measurement, control and laboratory use -- Part 031: Safety requirements for hand-held probe assemblies for electrical measurement and test	EN 61010-031	2015
IEC 61051-2	1991 ²	Varistors for use in electronic equipment -- Part 2: Sectional specification for surge suppression varistors	-	-
IEC 61180	series	High-voltage test techniques for low-voltage equipment -- Part 1: Definitions, test and procedure requirements	EN 61180	series
IEC 61180-1	-	High-voltage test techniques for low-voltage equipment -- Part 1: Definitions, test and procedure requirements	EN 61180-1	1994
IEC 61180-2	-	High-voltage test techniques for low-voltage equipment -- Part 2: Test equipment	EN 61180-2	1994
IEC 61643-21	2000 ²	Low voltage surge protective devices -- Part 21: Surge protective devices connected to telecommunications and signalling networks - Performance requirements and testing methods	-	-
IEC 61643-311	-	Components for low-voltage surge protective devices -- Part 311: Performance requirements and test circuits and methods for gas discharge tubes (GDT)	EN 61643-311	2013

IEC 61643-321	-	Components for low-voltage surge protective devices -- Part 321: Specifications for Avalanche Breakdown Diode (ABD)	EN 61643-321	2002
IEC 61643-331	-	Components for low-voltage surge protective devices -- Part 331: Specification for metal oxide varistors (MOV)	EN 61643-331	2003
IEC 61672-1	-	Electroacoustics - Sound level meters -- Part 1: Specifications	EN 61672-1	2013
IEC 61672-2	-	Electroacoustics - Sound level meters -- Part 2: Pattern evaluation tests	EN 61672-2	2013
-	-		+ A1	2017
IEC 62262	-	Degrees of protection provided by enclosures for electrical equipment against external mechanical impacts (IK code)	EN 62262	2002
IEC 62471 (mod)	-	Photobiological safety of lamps and lamp systems	EN 62471	2008
IEC/TR 62471-2	2009 ²	Photobiological safety of lamps and lamp systems - Part 2: Guidance on manufacturing requirements relating to non-laser optical radiation safety	-	-
IEC 62598	-	Nuclear instrumentation - Constructional requirements and classification of radiometric gauges	EN 62598	2013
IEC Guide 104	2010 ²	The preparation of safety publications and the use of basic safety publications and group safety publications	-	-
ISO/IEC Guide 51	2014	Safety aspects - Guidelines for their inclusion in standards	-	-
ISO 306	2013	Plastics - Thermoplastic materials - Determination of Vicat softening temperature (VST)	EN ISO 306	2013
ISO 361	1975 ²	Basic ionizing radiation symbol	-	-
ISO 3746	-	Acoustics - Determination of sound power levels and sound energy levels of noise sources using sound pressure - Survey method using an enveloping measurement surface over a reflecting plane	EN ISO 3746	2010
ISO 7000	2014 ²	Graphical symbols for use on equipment - Registered symbols	-	-
ISO 9614-1	-	Acoustics - Determination of sound power levels of noise sources using sound intensity -- Part 1: Measurement at discrete points	EN ISO 9614-1	2009
ISO 13857	-	Safety of machinery - Safety distances to prevent hazard zones being reached by upper and lower limbs	EN ISO 13857	2008

EN 378-2 2016² Refrigerating systems and heat pumps –
 Safety and environmental requirements.
 Design, construction, testing, marking and
 documentation

<http://www.china-gauges.com/>

1
2
3
4
5
6
7
8
9
10
11
12
13
14
15
16
17
18
19
20
21
22
23
24
25
26
27
28
29
30
31
32
33
34
35
36
37
38
39
40
41
42
43
44
45
46
47
48
49
50
51
52
53
54
55
56
57
58
59
60
61
62
63
64
65
66
67
68
69
70
71
72
73
74
75
76
77
78
79
80
81
82
83
84
85
86
87
88
89
90
91
92
93
94
95
96
97
98
99
100

Annex ZZ
 (informative)

Relationship between this European standard and the safety objectives of Directive 2014/35/EU [2014 OJ L96] aimed to be covered

This European Standard has been prepared under a Commission's standardization request relating to harmonized standards in the field of the Low Voltage Directive, M/511, to provide one voluntary means of conforming to safety objectives of Directive 2014/35/EU of the European Parliament and of the Council of 26 February 2014 on the harmonization of the laws of the Member States relating to the making available on the market of electrical equipment designed for use within certain voltage limits [2014 OJ L96].

Once this standard is cited in the Official Journal of the European Union under that Directive, compliance with the normative clauses of this standard given in Table ZZ.1 confers, within the limits of the scope of this standard, a presumption of conformity with the corresponding safety objectives of that Directive, and associated EFTA regulations.

Table ZZ.1 – Correspondence between this European standard EN 61010-1:2018 and Annex I of Directive 2014/35/EU [2014 OJ L96]

Safety objectives of Directive 2014/35/EU (Annex I)	Clause(s) / sub-clause(s) of this EN	Remarks / Notes
1. General conditions		
1 (a) the essential characteristics, the recognition and observance of which will ensure that electrical equipment will be used safely and in applications for which it was made, shall be marked on the electrical equipment, or, if this is not possible, on an accompanying document	5.1, 5.2, 5.4	
1 (b) the electrical equipment, together with its component parts, shall be made in such a way as to ensure that it can be safely and properly assembled and connected	6.6, 6.10, Annex F	http://www.china-gauges.com/
1 (c) the electrical equipment shall be so designed and manufactured as to ensure that protection against the hazards set out in points 2 and 3 is assured, providing that the equipment is used in applications for which it was made and is adequately maintained	5.4, 17 (for hazards not covered by clauses 6-16) See also the details in points 2 and 3	

Safety objectives of Directive 2014/35/EU (Annex I)	Clause(s) / sub-clause(s) of this EN	Remarks / Notes
2. Protection against hazards arising from the electrical equipment Measures of a technical nature shall be laid down in accordance with point 1, in order to ensure that:		
2 (a) persons and domestic animals are adequately protected against the danger of physical injury or other harm which might be caused by direct or indirect contact	4, 6.1 – 6.10, 9.6, 11.2, 11.6, Annex F, Annex K	
2 (b) temperatures, arcs or radiation which would cause a danger, are not produced	4.4.4.2, 9.5, 9.6, 10.1, - 10.5, 12	
2 (c) persons, domestic animals and property are adequately protected against non-electrical dangers caused by the electrical equipment which are revealed by experience	4.4, 7.2 - 7.6, 9, 12.3 - 12.6, 13.2.2, 13.2.3, 16.2, Annex DD	
2 (d) the insulation is suitable for foreseeable conditions	6.7, Annex K	
3. Protection against hazards which may be caused by external influences on the electrical equipment Technical measures shall be laid down in accordance with point 1, in order to ensure that the electrical equipment:		
3 (a) meets the expected mechanical requirements in such a way that persons, domestic animals and property are not endangered	7, 8	
3 (b) is resistant to non-mechanical influences in expected environmental conditions, in such a way that persons, domestic animals and property are not endangered	1.4, 6.7.2.2.1, 10.5, 11.6, 14.3, 14.8, 14.101, 14.102	
3 (c) does not endanger persons, domestic animals and property in foreseeable conditions of overload	4, 9, 14, 16.1	

<http://www.china-gauges.com/>

WARNING 1 — Presumption of conformity stays valid only as long as a reference to this European standard is maintained in the list published in the Official Journal of the European Union. Users of this standard should consult frequently the latest list published in the Official Journal of the European Union.

WARNING 2 — Other Union legislation may be applicable to the product(s) falling within the scope of this standard.

CONTENTS

FOREWORD.....	4
INTRODUCTION.....	6
1 Scope and object.....	7
2 Normative references	9
3 Terms and definitions	9
4 Tests	12
5 Marking and documentation.....	13
6 Protection against electric shock	14
7 Protection against mechanical HAZARDS.....	28
8 Resistance to mechanical stresses	29
9 Protection against the spread of fire	30
10 Equipment temperature limits and resistance to heat.....	31
11 Protection against HAZARDS from fluids	37
12 Protection against radiation, including laser sources, and against sonic and ultrasonic pressure	37
13 Protection against liberated gases and substances, explosion and implosion	37
14 Components and subassemblies	38
15 Protection by interlocks	39
16 HAZARDS resulting from application	39
17 RISK assessment.....	39
Annexes	40
Annex E (informative) Guideline for reduction of POLLUTION DEGREES	41
Annex F (normative) ROUTINE TESTS	43
Annex L (informative) Index of defined terms	45
Annex AA (informative) General approach to safety for control equipment	46
Annex BB (informative) System drawing of isolation boundaries	48
Annex CC (informative) Historical techniques for secondary circuits	59
Annex DD (normative) Flammability test for magnesium alloy fire EN 61010-2-201:2017 flame barriers (see 9.3.2).....	63
Annex EE (informative) Information/documentation and correlation to its uses.....	64
Annex FF (informative) Measurement of CLEARANCES and CREEPAGE DISTANCES.....	66
Bibliography.....	68
Figure 101 – Typical interface/port diagram of control equipment.....	16
Figure 102 – Requirements for insulation between separate circuits and between circuits and ACCESSIBLE conductive parts	22
Figure 103 – Mechanical HAZARDS, with regard to PANEL MOUNTED EQUIPMENT	28
Figure 104 – Spread of fire HAZARDS, with regard to PANEL MOUNTED EQUIPMENT.....	30
Figure 105 – General temperature test environment	33
Figure 106 – Vented equipment	34
Figure 107 – Non-vented equipment	35
Figure 108 – Panel mounted device extending through the wall of a cabinet.....	36

Figure AA.1 – Control equipment access and safety concerns	46
Figure BB.1 – Typical system ENCLOSURE layout	49
Figure BB.2 – Simplified system schematic	50
Figure BB.3 – HAZARD situation of the control equipment.....	51
Figure BB.4 – Application of the standard to the control equipment safety drawing	52
Figure BB.5 – Application of 6.7.1.5 items a) and b) to the control equipment safety drawing.....	52
Figure BB.6 – Application of 6.7.1.5 items a), b), c) and d) to the control equipment safety drawing	53
Figure BB.7 – REINFORCED INSULATION	54
Figure BB.8 – BASIC INSULATION.....	55
Figure BB.9 – REINFORCED INSULATION, BASIC INSULATION and PROTECTIVE IMPEDANCE	56
Figure BB.10 – REINFORCED INSULATION from external power supplies	57
Figure BB.11 – BASIC INSULATION from external power supplies	58
Figure EE.1 – Information/documentation for component products	64
Figure EE.2 – Information/documentation accumulation and segregation tree for an example installation	65
Figure FF.1 – The path a component mounted to a PWB (side view).....	67
Figure FF.2 – The path a component mounted to a PWB (side view).....	67
Table 101 – Overload test circuit values	12
Table 102 – Endurance test circuit values	13
Table 103 – OPERATOR ACCESSIBLE ports for open and ENCLOSED EQUIPMENT	17
Table 4 – CLEARANCE and CREEPAGE DISTANCES for MAINS CIRCUITS of OVERVOLTAGE CATEGORY II up to 300 V.....	24
Table 5 – Test voltages for solid insulation between MAINS and between MAINS and secondary circuits OVERVOLTAGE CATEGORY II up to 300 V ^d	25
Table 6 – CLEARANCES and test voltages for secondary circuits derived from MAINS CIRCUITS of OVERVOLTAGE CATEGORY II up to 300 V	26
Table 104 – Minimum CREEPAGE and CLEARANCE in air of OVERVOLTAGE CATEGORY II up to 1 000 V at FIELD-WIRING TERMINALS ^{d, e}	27
Table 19 – Surface temperature limits, under NORMAL CONDITION.....	http://www.china-gauges.com/
Table E.1 – Environmental situations	41
Table E.2 – Reduction of POLLUTION DEGREES (PD)	42
Table CC.1 – Limits of output current and output power for inherently limited power sources.....	61
Table CC.2 – Limits of output current, output power and RATINGS for over-current protective devices for non-inherently limited power sources	62
Table FF.1 – Dimensions of X.....	66

INTERNATIONAL ELECTROTECHNICAL COMMISSION

—————

**SAFETY REQUIREMENTS FOR ELECTRICAL EQUIPMENT
FOR MEASUREMENT, CONTROL, AND LABORATORY USE –**
Part 2-201: Particular requirements for control equipment

FOREWORD

- 1) The International Electrotechnical Commission (IEC) is a worldwide organization for standardization comprising all national electrotechnical committees (IEC National Committees). The object of IEC is to promote international co-operation on all questions concerning standardization in the electrical and electronic fields. To this end and in addition to other activities, IEC publishes International Standards, Technical Specifications, Technical Reports, Publicly Available Specifications (PAS) and Guides (hereafter referred to as "IEC Publication(s)"). Their preparation is entrusted to technical committees; any IEC National Committee interested in the subject dealt with may participate in this preparatory work. International, governmental and non-governmental organizations liaising with the IEC also participate in this preparation. IEC collaborates closely with the International Organization for Standardization (ISO) in accordance with conditions determined by agreement between the two organizations.
- 2) The formal decisions or agreements of IEC on technical matters express, as nearly as possible, an international consensus of opinion on the relevant subjects since each technical committee has representation from all interested IEC National Committees.
- 3) IEC Publications have the form of recommendations for international use and are accepted by IEC National Committees in that sense. While all reasonable efforts are made to ensure that the technical content of IEC Publications is accurate, IEC cannot be held responsible for the way in which they are used or for any misinterpretation by any end user.
- 4) In order to promote international uniformity, IEC National Committees undertake to apply IEC Publications transparently to the maximum extent possible in their national and regional publications. Any divergence between any IEC Publication and the corresponding national or regional publication shall be clearly indicated in the latter.
- 5) IEC itself does not provide any attestation of conformity. Independent certification bodies provide conformity assessment services and, in some areas, access to IEC marks of conformity. IEC is not responsible for any services carried out by independent certification bodies.
- 6) All users should ensure that they have the latest edition of this publication.
- 7) No liability shall attach to IEC or its directors, employees, servants or agents including individual experts and members of its technical committees and IEC National Committees for any personal injury, property damage or other damage of any nature whatsoever, whether direct or indirect, or for costs (including legal fees) and expenses arising out of the publication, use of, or reliance upon, this IEC Publication or any other IEC Publications.
- 8) Attention is drawn to the Normative references cited in this publication. Use of the referenced publications is indispensable for the correct application of this publication. <http://www.china-gauges.com/>
- 9) Attention is drawn to the possibility that some of the elements of this IEC Publication may be the subject of patent rights. IEC shall not be held responsible for identifying any or all such patent rights.

International Standard IEC 61010-2-201 has been prepared by IEC technical committee 65: Industrial-process measurement, control and automation.

The text of this standard is based on the following documents:

FDIS	Report on voting
65/652/FDIS	65/657/RVD

Full information on the voting for the approval of this standard can be found in the report on voting indicated in the above table.

This second edition cancels and replaces the first edition published in 2013. This edition constitutes a technical revision.

This second edition includes the following significant technical changes with respect to the previous edition;

- a) clarify, change, delete definitions which were causing confusion,
- b) change and clarify the temperature testing methodology,
- c) change documentation methodologies allowed,
- d) change some TERMINAL markings,
- e) add clarity to some of the informative annexes,
- f) add Annex E with changes,
- g) add Annexes AA – FF.

This publication has been drafted in accordance with the ISO/IEC Directives, Part 2.

This Part 2-201 is intended to be used in conjunction with IEC 61010-1. It was established on the basis of the third edition (2010) of that standard. Consideration may be given to future editions of, or amendments to, IEC 61010-1.

This Part 2-201 supplements or modifies the corresponding clauses in IEC 61010-1 so as to convert that publication into the IEC standard: *Particular requirements for control equipment*.

Where a particular subclause of Part 1 is not mentioned in this part 2, that subclause applies as far as is reasonable. Where this part states “addition”, “modification”, “replacement”, or “deletion”, the relevant requirement, test specification or NOTE in Part 1 should be adapted accordingly.

In this standard, the following print types are used:

- requirements and definitions: in roman type;
- NOTES: in smaller roman type;
- *conformity and tests: in italic type;*
- terms used throughout this standard which have been defined in Clause 3: SMALL ROMAN CAPITALS.

A list of all parts in the IEC 61010 series, published under the general title *Safety requirements for electrical equipment for measurement, control and laboratory use*, can be found on the IEC website.

The committee has decided that the contents of this publication will remain unchanged until the stability date indicated on the IEC website under "<http://webstore.iec.ch>" in the data related to the specific publication. At this date, the publication will be

- reconfirmed,
- withdrawn,
- replaced by a revised edition, or
- amended.

IMPORTANT – The 'colour inside' logo on the cover page of this publication indicates that it contains colours which are considered to be useful for the correct understanding of its contents. Users should therefore print this document using a colour printer.

INTRODUCTION

IEC 61010-2-2xx documents are a series of standards on safety of industrial-process measurement, control and automation equipment.

This part specifies the complete safety related requirements and related tests for control equipment (e.g. programmable controller (PLC), the components of distributed control systems (DCS), I/O devices, human machine interface (HMI)).

Safety terms of general use are defined in IEC 61010-1. More specific terms are defined in each part of IEC 61010.

<http://www.china-gauges.com/>

SAFETY REQUIREMENTS FOR ELECTRICAL EQUIPMENT FOR MEASUREMENT, CONTROL, AND LABORATORY USE –

Part 2-201: Particular requirements for control equipment

1 Scope and object

This clause of Part 1 is applicable, except as follows.

1.1.1 Equipment included in scope

Replacement:

- This part of IEC 61010 specifies safety requirements and related verification tests for any product performing the function of control equipment and/or their associated peripherals. In addition, these products have as their intended use the command and control of machines, automated manufacturing and industrial processes, e.g. discrete and continuous control. Some equipment examples are: programmable logic controller (PLC);
- programmable automation controller (PAC);
- distributed control systems (DCS);
- remote I/O;
- industrial PC (computers) and panel PC;
- programming and debugging tools (PADTs);
- displays and human-machine interfaces (HMI);
- positioners.

Components of the above named equipment and in the scope of this standard are:

- (auxiliary) stand-alone power supplies;
- peripherals such as digital and analogue I/O, remote-I/O;
- industrial network equipment.

Control equipment and their associated peripherals are intended to be used in an industrial environment and may be provided as OPEN or ENCLOSED EQUIPMENT. <http://www.china-gauges.com/>

NOTE 1 Control equipment intended also for use in other environments or for other purposes (example: for use in building installations to control light or other electrical installations, or for use on cars, trains or ships) can have additional conformity requirements defined by the safety standard(s) for these applications. These requirements can involve as example: insulation, spacings and power restrictions.

NOTE 2 Computing devices and similar equipment within the scope of IEC 60950 (planned to be replaced by IEC 62368) and conforming to its requirements are considered to be suitable for use with control equipment within the scope of this standard. However, some of the requirements of IEC 60950 for resistance to moisture and liquids are less stringent than those in IEC 61010-1:2010, 5.4.4 second paragraph.

Control equipment covered in this standard is intended for use in OVERVOLTAGE CATEGORY II, III and IV (IEC 60664-1) in low-voltage installations, where the RATED equipment supply voltage does not exceed AC 1 000 V r.m.s. (50/60 Hz), or DC 1 000 V.

The requirements of ISO/IEC Guide 51 and IEC Guide 104, as they relate to this part of IEC 61010, are incorporated herein.

1.1.2 Equipment excluded from scope

Replacement:

This standard does not deal with aspects of the overall automated system, e.g. a complete assembly line. Control equipment (e.g. DCS and PLC), their application program and their associated peripherals are considered as components (components in this context are items which perform no useful function by themselves) of an overall automated system.

Since control equipment (e.g. DCS and PLC) are component devices, safety considerations for the overall automated system including installation and application are beyond the scope of this standard. Refer to IEC 60364 series of standards or applicable national/local regulations for electrical installation and guidelines.

1.2.1 Aspects included in scope

Replacement:

The purpose of the requirements of this standard is to ensure that all HAZARDS to the OPERATOR, SERVICE PERSONNEL and the surrounding area are reduced to a tolerable level.

NOTE 1 By using the terms "OPERATOR" and "SERVICE PERSONNEL" this standard considers the perception of HAZARDS depending on training and skills. Annex AA gives a general approach in this regard.

Requirements for protection against particular types of HAZARD are given in Clauses 6 to 17, as follows:

- a) electric shock or burn (see Clause 6);
- b) mechanical HAZARDS (see Clauses 7 and 8);
- c) spread of fire from the control equipment (see Clause 9);
- d) excessive temperature (see Clause 10);
- e) effects of fluids and fluid pressure (see Clause 11);
- f) effects of radiation, including lasers sources, and sonic and ultrasonic pressure (see Clause 12);
- g) liberated gases, explosion and implosion (see Clause 13);
- h) arising from REASONABLY FORESEEABLE MISUSE and ergonomic factors are specified in (see Clause 16);
- i) RISK assessment for HAZARDS or environments not fully covered <http://www.china-gauges.com/> (see Clause 17)

NOTE 2 Attention is drawn to the existence of additional requirements regarding the health and safety of labour forces.

1.2.2 Aspects excluded from scope

Replacement:

This standard does not cover:

- a) reliability, functionality, performance, or other properties of the control equipment not related to safety;
- b) mechanical or climatic requirements for operation, transport or storage;
- c) EMC requirements (see e.g. IEC 61326 or IEC 61131-2);
- d) protective measures for explosive atmospheres (see e.g. IEC 60079 series);
- e) functional safety (see e.g. IEC 61508, IEC 61131-6).

2 Normative references

This clause of Part 1 is applicable, except as follows.

Addition:

IEC 60384-14, *Fixed capacitors for use in electronic equipment – Part 14: Sectional specification: Fixed capacitors for electromagnetic interference suppression and connection to the supply mains*

IEC 60664-1, *Insulation coordination for equipment within low-voltage systems – Part 1: Principles, requirements and tests*

IEC 60695-2-11, *Fire hazard testing – Part 2-11: Glowing/hot-wire based test methods – Glow-wire flammability test method for end-products (GWEPT)*

IEC 60695-11-3, *Fire hazard testing – Part 11-3: Test flames – 500 W flames – Apparatus and confirmational test methods*

IEC 60947-5-1, *Low-voltage switchgear and controlgear – Part 5-1: Control circuit devices and switching elements – Electromechanical control circuit devices*

IEC 61010-1:2010, *Safety requirements for electrical equipment for measurement, control, and laboratory use – Part 1: General requirements*

IEC 61010-2-030, *Safety requirements for electrical equipment for measurement, control, and laboratory use – Part 2-030: Particular requirements for testing and measuring circuits*

IEC 61051-2, *Varistors for use in electronic equipment – Part 2: Sectional specification for surge suppression varistors*

IEC 61643-21, *Low voltage surge protective devices – Part 21: Surge protective devices connected to telecommunications and signalling networks – Performance requirements and testing methods*

IEC 61643-311, *Components for low-voltage surge protective devices – Part 311: Performance requirements and test circuits for gas discharge tubes (GDT)*

IEC 61643-321, *Components for low-voltage surge protective devices – Part 321: Specifications for avalanche breakdown diode (ABD)* <http://www.china-gauges.com/>

IEC 61643-331, *Components for low-voltage surge protective devices – Part 331: Specification for metal oxide varistors (MOV)*

3 Terms and definitions

This clause of Part 1 is applicable, except as follows.

3.2.3

PROTECTIVE CONDUCTOR TERMINAL

Modification:

In this part “PROTECTIVE CONDUCTOR TERMINAL” is replaced by “PROTECTIVE EARTH TERMINAL”.

Note 1 to entry: PROTECTIVE EARTH TERMINAL is most familiar to industrial users, manufacturers, etc. Therefore since this part is targeted towards industrial use, the most familiar term is utilized.

3.5.11 OPERATOR

Addition:

Note 1 to entry: See definition in Part 1 and Annex AA.

Add the following terms and definitions:

3.101 AMBIENT TEMPERATURE

temperature, determined under prescribed conditions, of the air surrounding the equipment

3.102 ENCLOSED EQUIPMENT

equipment which includes an ENCLOSURE, having safety capability, or combination of an ENCLOSURE, having safety capability, and installation provisions enclosing on all sides, with the possible exception of its mounting surface, to prevent personnel from accidentally touching HAZARDOUS LIVE, hot or moving parts contained therein and meeting requirements of mechanical strength, flammability, and stability (where applicable)

Note 1 to entry: Examples are portable and HAND-HELD EQUIPMENT.

Note 2 to entry: This definition is related to IEC 60050-441:2000, 441-12-02.

3.103 ENCLOSURE

housing affording the type and degree of protection suitable for the intended application

Note 1 to entry: An ENCLOSURE, in general, may or may not have any safety capabilities, which depend on its application and construction.

Note 2 to entry: In this standard an ENCLOSURE is assumed to have safety capability, unless specifically stated otherwise.

[SOURCE: IEC 60050-195:1998, 195-02-35, modified – the notes to entry have been added]

3.104 EXTERNAL CIRCUIT

circuit connected by FIELD WIRING of the control equipment

<http://www.china-gauges.com/>

3.105 FIELD WIRING

wiring of the control equipment, which is not installed in the control equipment manufacturer's facility

Note 1 to entry: Examples of FIELD WIRING are power supply, digital and analogue input and output wiring.

Note 2 to entry: Control equipment manufacturer's, e.g. pre-assembled or molded cabling is not considered FIELD WIRING.

3.106 MODULAR EQUIPMENT

equipment consisting of different modules such as a Rack, CPU, different I/O-modules, network modules etc.

Note 1 to entry: MODULAR EQUIPMENT can:

- a) be OPEN EQUIPMENT or ENCLOSED EQUIPMENT;
- b) consist of modules that cannot operate alone or of a basic module that is operational alone and can be enhanced in functions by additional modules;

- c) vary in size and functionality depending on the combination and the number of modules;
- d) be combined with operational equipment or enhanced in function by the addition of modules by the customer.

3.107**OPEN EQUIPMENT**

equipment which does not protect personnel from accidentally touching HAZARDOUS LIVE or moving parts contained therein nor meet requirements of mechanical strength, flammability and stability (where applicable)

Note 1 to entry: See Annex AA.

3.108**OPERATOR**

Addition:

Note 1 to entry: See definition in Part 1 and Annex AA of this document.

3.109**PANEL MOUNTED EQUIPMENT**

equipment where a portion of the equipment may form part of the ENCLOSURE

Note 1 to entry: See Figure 103.

3.110**PORTABLE EQUIPMENT**

equipment intended to be carried by hand and not fixed during NORMAL USE

3.111**PROTECTIVE EXTRA-LOW VOLTAGE CIRCUIT****PELV CIRCUIT**

protective earth referenced electrical circuit in which the voltage cannot exceed the following:

NORMAL CONDITION and SINGLE FAULT CONDITION: The AC voltage levels are 30 V r.m.s., 42,4 V peak and the DC voltage level is 60 V. For equipment intended for use in WET LOCATIONS, the AC voltage levels are 16 V r.m.s., 22,6 V peak and the DC voltage level is 35 V.

[SOURCE: IEC 60050-826-12-32:2004, modified – clarified and more fully described]

3.112**SAFETY EXTRA-LOW VOLTAGE CIRCUIT****SELV CIRCUIT**

non-protective earth referenced electrical circuit in which the voltage cannot exceed the following: <http://www.china-gauges.com/>

NORMAL CONDITION and SINGLE FAULT CONDITION: The AC voltage levels are 30 V r.m.s., 42,4 V peak and the DC voltage level is 60 V. For equipment intended for use in WET LOCATIONS, the AC voltage levels are 16 V r.m.s., 22,6 V peak and the DC voltage level is 35 V.

[SOURCE: IEC 60050-826-12-31:2004, modified – clarified and more fully described]

3.113**SERVICE PERSONNEL**

person, with the appropriate technical training, experience and awareness of HAZARDS and of measures to minimize danger to themselves, other persons or to the control equipment, in an industrial environment, changing or repairing the control equipment

Note 1 to entry: SERVICE PERSONNEL are persons having the appropriate technical training and experiences necessary to be aware of HAZARDS – e.g. electrical HAZARDS, temperature HAZARDS, fire HAZARDS – to which they are exposed in performing a task and of measures to minimize danger to themselves or to other persons or to the control equipment, in an industrial environment.

Note 2 to entry: SERVICE PERSONNEL change or repair the control equipment e.g. hardware configuration or installing software updates provided by the manufacturer.

4 Tests

This clause of Part 1 is applicable, except as follows.

4.1 General

Addition:

The product is verified to this standard in a test configuration, defined by the manufacturer, which represents the least favourable configuration. See 4.3.

It is likely or possible that there are different test configurations which yield least favourable test conditions. For example there may be a least favourable configuration for temperature test, and a different least favourable test configuration for voltage test. If this is the case then the appropriate least favourable test configuration(s) shall be used with regard to 4.3.2 and 4.4.

These least favourable test configurations and test conditions shall be practical and useful for the intended applications.

Conformity verification: The selected test configuration(s) and test conditions shall be documented with the rationale in the test report.

4.4.2 Application of fault conditions

Add the following subclause:

4.4.2.101 Switching devices tests

4.4.2.101.1 Overload test

Switching devices shall close and open a test circuit having the current, voltage, and power factor values given in Table 101. Fifty cycles, each consisting of 1 closing and 1 opening, shall be completed using a timing of 1 s ON, 9 s OFF. After completion of the 50 cycles, the equipment shall be subjected to the endurance test in 4.4.2.101.2, if required by 14.102.

Table 101 – Overload test circuit values<http://www.china-gauges.com/>

Intended load	Current	Voltage	Power factor
AC general use	1,5 × RATED	RATED	0,75 to 0,80
DC general use	1,5 × RATED	RATED	–
AC resistance	1,5 × RATED	RATED	1,0
DC resistance	1,5 × RATED	RATED	–
AC pilot duty ^a	RATED ^a	1,1 × RATED ^b	<0,35
DC pilot duty ^a	RATED ^a	1,1 × RATED ^b	–
NOTE 1 Source IEC 60947-5-1.			
NOTE 2 Pilot duty = RATING assigned to a relay or switch that controls the coil of another relay or switch.			
^a Unless otherwise specified, the inrush current shall be 10 times the steady-state current.			
^b Set up the EUT at its RATED voltage and current and then increase the voltage by 10 % without further adjustment of the load.			

Conformity, pass/fail, is determined by test completion without electrical/mechanical breakdown of the equipment and an additional dielectric voltage test.

4.4.2.101.2 Endurance test

After completion of the overload test in 4.4.2.101.1, the switching device is to close and open a test circuit having the current, voltage, and power factor values given in Table 102. A total of 6 000 cycles, consisting of 1 closing and 1 opening, shall be completed. The cycle timing shall be 1 s ON and 9 s OFF, except for the first 1 000 cycles of the pilot duty test. The first 1 000 cycles of the pilot duty test shall be at a rate of 1 cycle per second except that the first 10 to 12 cycles are to be as fast as possible.

The endurance test need not be conducted on solid-state output devices for general or resistive use.

Table 102 – Endurance test circuit values

Intended load	Current	Voltage	Power factor
AC general use	RATED	RATED	0,75 to 0,80
DC general use	RATED	RATED	–
AC resistance	RATED	RATED	1,0
DC resistance	RATED	RATED	–
AC pilot duty ^a	RATED	RATED	<0,35
DC pilot duty ^a	RATED	RATED	–

NOTE 1 Source IEC 60947-5-1.

NOTE 2 Pilot duty = RATING assigned to a relay or switch that controls the coil of another relay or switch.

^a The test circuit is identical to the overload test circuit except that the voltage is the RATED voltage.

Conformity, pass/fail, is determined by test completion without electrical/mechanical breakdown of the equipment and an additional dielectric voltage test.

5 Marking and documentation

This clause of Part 1 is applicable, except as follows.

<http://www.china-gauges.com/>

5.1.5.2 TERMINALS

Modification:

Replace item a) as follows:

- a) FUNCTIONAL EARTH TERMINALS (i.e. used for non-safety purposes such as interference immunity improvement) shall be marked with one of the following symbols:



IEC 60417-5018 (2002-10) or



symbol 5 of Part 1, IEC 60417-5017 (2006-08).

Where a TERMINAL serves both as the PROTECTIVE CONDUCTOR TERMINAL and as a FUNCTIONAL EARTH TERMINAL, symbol 6 and other requirements for PROTECTIVE CONDUCTOR TERMINAL shall be applied. Where a TERMINAL serves both as an earth (bonding) TERMINAL

and FUNCTIONAL EARTH TERMINAL, symbol 5 and other requirements for earth TERMINALS shall be applied.

5.1.8 FIELD WIRING TERMINAL boxes

Addition after first paragraph:

A FIELD WIRING TERMINAL need not be marked to indicate the temperature RATING if it is intended for the connection of a control circuit conductor only.

A control circuit is any circuit that does not carry MAINS power and is generally limited to 15 A.

5.4.1 General

Addition:

For equipment intended to be installed by SERVICE PERSONNEL or trained installers, all documentation may be provided by electronic media.

Where the documentation is provided by electronic media, this may be accomplished by including the symbol No. 14 of Table 1 (ISO 7000-0434B: 2004-01), on the product, and the location of the documentation, e.g. URL, QRcode, on the product, packaging or printed information with the product.

5.4.3 Equipment installation

Addition:

h) OPEN EQUIPMENT: If the control equipment is classified as OPEN EQUIPMENT its documentation shall specify the ENCLOSURE that has to be provided by the user, e.g. mechanical rigidity, IP RATING;

NOTE See also 7.1.101 and 8.1.101.

Modification:

Replace item d)1) as follows:

d) 1) supply and FIELD WIRING requirements, e.g. insulation, temperature RATING;

5.4.4 Equipment operation

<http://www.china-gauges.com/>

Modification:

j) details of methods of reducing the RISKS of burns from surfaces permitted to exceed the temperature limits of 10.1, Table 19.

6 Protection against electric shock

This clause of Part 1 is applicable, except as follows.

6.1.2 Exceptions

Replacement:

If it is not feasible for operating reasons to prevent the following parts being both ACCESSIBLE and HAZARDOUS LIVE, they are permitted to be ACCESSIBLE to SERVICE PERSONNEL during NORMAL USE while they are HAZARDOUS LIVE:

For example:

- a) parts of lamps and lamp sockets after lamp removal:
- b) parts intended to be replaced by SERVICE PERSONNEL (for example, batteries) and which may be HAZARDOUS LIVE during the replacement or other SERVICE PERSONNEL action, but only if they are ACCESSIBLE only by means of a TOOL and have a warning marking (see 5.2):

If any of the parts in examples a) and b) receive a charge from an internal capacitor, they shall not be HAZARDOUS LIVE 10 s after interruption of the supply.

If a charge is received from an internal capacitor, conformity is checked by the measurements of 6.3 to establish that the levels of 6.3.1 c) are not exceeded.

6.2.1 General

This subclause of Part 1 is applicable to ENCLOSED EQUIPMENT.

6.2.2 Examination

This subclause of Part 1 is applicable to ENCLOSED EQUIPMENT.

6.2.3 Openings above parts that are HAZARDOUS LIVE

This subclause of Part 1 is applicable to ENCLOSED EQUIPMENT.

6.2.4 Openings for pre-set controls

Addition:

First paragraph: This subclause of Part 1 is applicable to ENCLOSED EQUIPMENT. This subclause applies to SERVICE PERSONNEL only.

Add the following subclauses:

<http://www.china-gauges.com/>

6.2.101 Accessibility of TERMINALS and ports

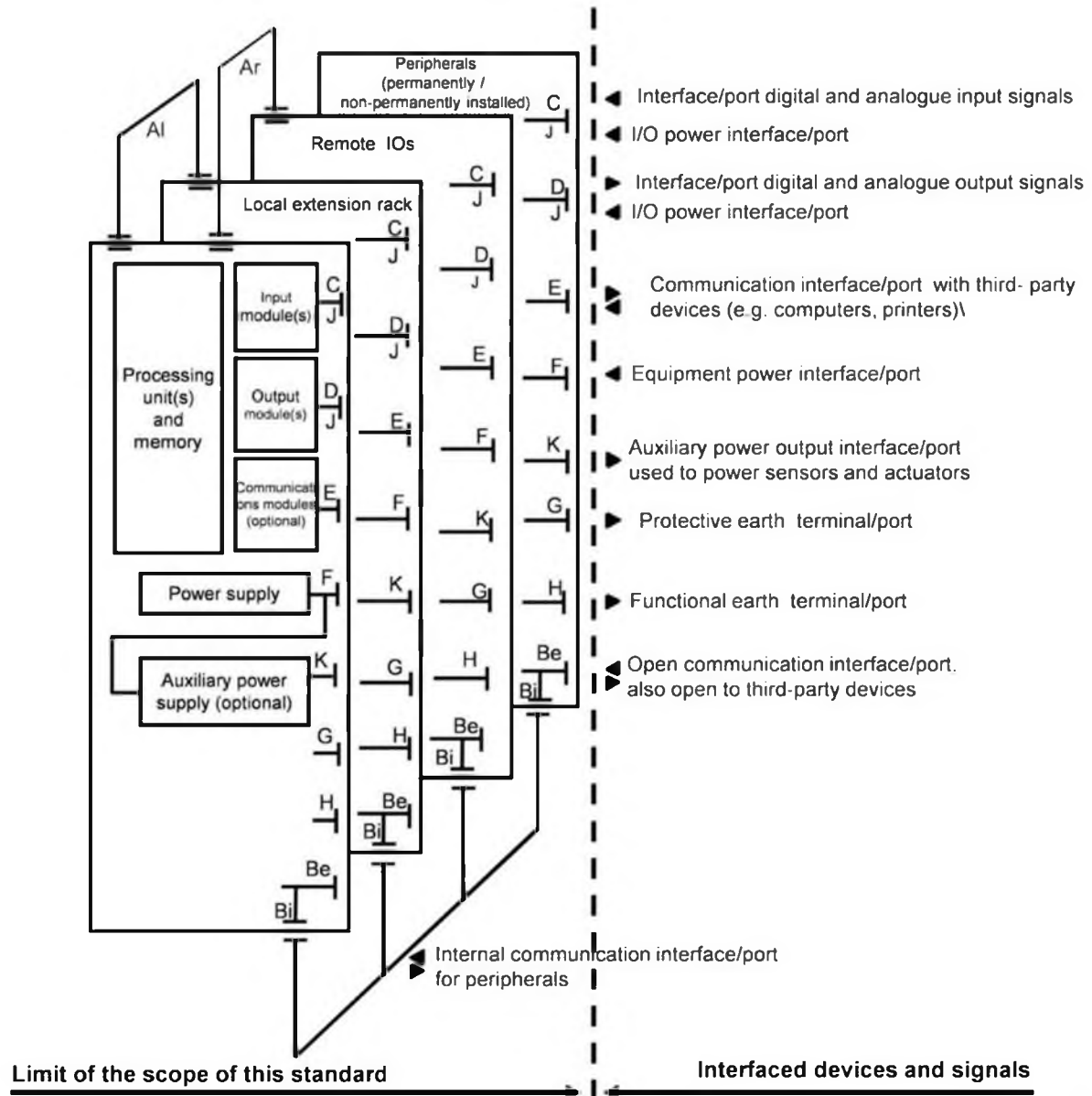

IEC

<http://www.china-gauges.com/>

Key

- AI Communication interface/port for local extension rack
- Ar Communication interface/port for remote I/O station, control network, fieldbus
- Be Open communication interface/port, also open to third-party devices; e.g. PADT, personal computer used for programming
- Bi Internal communication interface/port for peripherals
- C Interface/port for digital and analogue input signals
- D Interface/port for digital and analogue output signals
- E Serial or parallel communication interfaces/ports for data communication with third-party devices; e.g. computers, printers
- F Equipment power interface/port.
- G PROTECTIVE EARTH TERMINAL/port
- H FUNCTIONAL EARTH TERMINAL/port
- J I/O power interface/port
- K Auxiliary power output interface/port used to power sensors and actuators

Figure 101 – Typical interface/port diagram of control equipment

Table 103 defines whether ports of control equipment are OPERATOR ACCESSIBLE, and thus require protection against electric shock. Other than for Ports Ar, Be and E, protection can be achieved by making the HAZARDOUS LIVE parts within the port not ACCESSIBLE.

Table 103 – OPERATOR ACCESSIBLE ports for open and ENCLOSED EQUIPMENT

Port	OPERATOR ACCESSIBLE ^c	
	OPEN EQUIPMENT	ENCLOSED EQUIPMENT
Al communication interface/port for local extension rack	No	Yes
Ar communication interface/port for remote IO station, control network, fieldbus ^a	Yes	Yes
Be open communication interface/port, also open to third-party devices; e.g. PADT, personal computer used for programming ^a	Yes	Yes
Bi internal communication interface/port for peripherals	No	Not applicable ^b
C interface/port for digital and analogue input signals	No	Yes
D interface/port for digital and analogue output signals	No	Yes
E serial or parallel communication interfaces/ports for data communication with third-party devices; e.g. computers and printers ^a	Yes	Yes
F equipment power interface/port	No	Yes
G PROTECTIVE EARTH TERMINAL/port	No	Yes
H FUNCTIONAL EARTH TERMINAL/port	No	Yes
J I/O power interface/port	No	Yes
K auxiliary power output interface/port used to power sensors and actuators	No	Yes
^a Ports Ar, Be and E contain circuits which may be connected to other equipment and shall be considered ACCESSIBLE. ^b Port Bi is an internal communication port and thus never leaves the ENCLOSED EQUIPMENT, by definition. ^c Under special circumstances, some ports of either OPEN or ENCLOSED EQUIPMENT may or may not be considered OPERATOR ACCESSIBLE.		

OPERATOR ACCESSIBLE parts and the ports, as defined in Table 103 as OPERATOR ACCESSIBLE = Yes shall be prevented from becoming HAZARDOUS LIVE under normal and single-fault conditions.

Conformity is checked by inspection and in case of doubt by measurement <http://www.china-gauges.com/> to 6.2.

6.2.102 Control equipment

6.2.102.1 ACCESSIBLE parts

ACCESSIBLE parts of control equipment shall not be, or in the case of a single fault, become HAZARDOUS LIVE. Although these requirements are principally directed at ENCLOSED EQUIPMENT, these requirements also apply TO OPEN EQUIPMENT. When applied to OPEN EQUIPMENT, the control equipment shall be considered to be installed, according to the manufacturer's instructions. Also see 5.4.3 and Annex AA.

If SERVICE PERSONNEL are required to make adjustments, etc., during e.g. commissioning of OPEN EQUIPMENT, then protection from HAZARDS in the area near the adjustment shall be provided to prevent contact. If the HAZARD is not indicated by a warning label (see 5.2) then other protective means e.g. ENCLOSURE or PROTECTIVE BARRIER is required.

Conformity is checked by inspection and examination according to 6.2.2.

6.2.102.2 SELV/PELV circuits

SELV/PELV circuits do not require additional evaluation for RISK against electrical shock, provided that those circuits are in dry locations.

6.5.2.1 General

Addition:

NOTE 101 PROTECTIVE CONDUCTOR TERMINALS and earth contacts are not connected directly to the neutral TERMINAL within the equipment. This does not prevent the connection of appropriately RATED devices (such as capacitors or surge suppression devices) between the PROTECTIVE EARTH TERMINAL and neutral.

6.5.2.6 Transformer PROTECTIVE BONDING screen

Modification:

Add the following second paragraph:

If the control equipment has no overcurrent protection means for the winding then the test current shall be twice the RATING of the control equipment overcurrent protection means (e.g. fuse, circuit breaker). This overcurrent protection means may be integrated into the control equipment either or specified in the manual.

Add the following subclauses:

6.5.2.101 Classes of equipment or equipment classes

6.5.2.101.1 General

Equipment classes are described to designate the means by which electric shock protection is maintained in NORMAL CONDITION and single-fault conditions of the installed equipment.

NOTE Derived from IEC 61140:2001, Clause 7.

6.5.2.101.2 Class I equipment

Equipment in which protection against electric shock is achieved using BASIC INSULATION. And additionally a means of connecting the conductive parts, which are otherwise capable of assuming HAZARDOUS LIVE voltages if the BASIC INSULATION fails, to the protective earth conductor.

<http://www.china-gauges.com/>

NOTE Class I equipment can have parts with DOUBLE INSULATION or REINFORCED INSULATION or parts operating at safety extra-low voltage.

If a flexible cord is utilized, it shall include a provision for a protective earth conductor that shall be part of the cord set.

ACCESSIBLE conductive parts of equipment, which may become HAZARDOUS LIVE in the event of a single fault, shall be connected to the protective circuit of the equipment. Conductive parts, such as screws, rivets and nameplates, which otherwise could become HAZARDOUS LIVE under single-fault conditions, shall be protected by other means such as double/REINFORCED INSULATION so that they do not become HAZARDOUS LIVE.

When a part of the equipment is removed from the ENCLOSURE, for normal maintenance, for example, the protective circuits serving other parts of the equipment shall not be interrupted.

Protective earth requirements are specified in 6.5.2.102 or 6.5.2.103.

6.5.2.101.3 Class II equipment

Equipment in which protection against electric shock does not rely on BASIC INSULATION only, but also on the provision of additional safety precautions, such as DOUBLE INSULATION or REINFORCED INSULATION. There is no provision for protective earth or reliance upon installation conditions.

A PROTECTIVE IMPEDANCE may be used in lieu of DOUBLE INSULATION.

A means for maintaining the continuity of circuits is acceptable (i.e. grounded internal components or conductive surfaces) provided that these circuits are double insulated from the ACCESSIBLE circuits of the equipment.

Connection to the earth TERMINALS for functional purposes is acceptable (such as radiofrequency interference suppression) provided the DOUBLE INSULATION system is still provided for protective purposes.

Equipment may be of one of the following types:

- a) insulation-encased by a durable and substantially continuous ENCLOSURE of insulating material which envelops all conductive parts. Small parts, such as nameplates, screws and rivets are exempted if they are isolated from HAZARDOUS LIVE parts by insulation at least equivalent to REINFORCED INSULATION;
- b) metal-encased by a substantially continuous metal ENCLOSURE, in which DOUBLE INSULATION is used throughout, except for those parts where REINFORCED INSULATION is used;
- c) combination of a) and b).

NOTE 1 Insulation-encasement can form a part of the whole of the SUPPLEMENTARY INSULATION or of the REINFORCED INSULATION.

NOTE 2 Utilization of DOUBLE INSULATION and/or REINFORCED INSULATION throughout, with a PROTECTIVE EARTH TERMINAL or contact, is deemed to be of class I construction.

NOTE 3 This equipment may have parts operating at safety extra-low voltage.

6.5.2.101.4 Class III equipment

Equipment in which protection against electric shock is provided by circuits supplied by safety extra-low voltage (SELV/PELV). And additionally, the voltages generated by or within the equipment do not exceed the limits for SELV/PELV.

<http://www.china-gauges.com/>

Connection to the earth TERMINALS for functional purposes is acceptable (such as radiofrequency interference suppression).

Wiring for SELV/PELV circuits shall be either segregated from the wiring for circuits other than SELV/PELV, or the insulation of all conductors shall be RATED for the higher voltage. Alternatively, earthed screening or additional insulation shall be arranged around the wiring for SELV/PELV circuits or around the wiring of other circuits, based on IEC 60364-4-41.

6.5.2.102 Protective earth requirements for ENCLOSED EQUIPMENT

The ACCESSIBLE parts of Class I equipment (e.g. chassis, frame and fixed metal parts of metal ENCLOSURES) other than those which cannot become HAZARDOUS LIVE shall be electrically interconnected and connected to a PROTECTIVE EARTH TERMINAL.

This requirement can be met by structural parts providing adequate electrical continuity. This applies whether the equipment is used on its own or incorporated in an assembly.

Cords or cables that supply power to Class I equipment PORTABLE EQUIPMENT peripherals shall be provided with a protective earth conductor.

ACCESSIBLE isolated conductive parts are considered not to constitute a danger if they are so located as to exclude any contact with live parts and withstand the dielectric test voltage of Table 5 for REINFORCED INSULATION, corresponding to the highest RATED operational voltage of the unit.

Class II equipment may have an internal functional earth bonding conductor but shall not be provided with a PROTECTIVE EARTH TERMINAL or a protective earth conductor in the equipment power input cord.

If the equipment is provided with a PROTECTIVE EARTH TERMINAL (Class I equipment), the following requirements also apply in addition to the previous general connection specifications.

- The PROTECTIVE EARTH TERMINAL shall be readily ACCESSIBLE and so placed that the connection of the equipment to the protective earth conductor is maintained when the cover or any removable part is removed.
- Products which are intended for MAINS cord connected use (such as equipment peripherals) shall be provided with a PROTECTIVE EARTH TERMINAL integral to the plug cap or socket (if removable cord set).
- The PROTECTIVE EARTH TERMINAL shall be of screw, stud or pressure type and shall be made of a suitable corrosion resistant material.
- The clamping means of PROTECTIVE EARTH TERMINALS shall be adequately locked against accidental loosening, and it shall not be possible to loosen them without the aid of a TOOL.
- PROTECTIVE EARTH TERMINALS and earth contacts shall not be connected direct to the neutral TERMINAL within the equipment. This does not prevent the connection of appropriately RATED devices (such as capacitors or surge suppression devices) between the PROTECTIVE EARTH TERMINAL and neutral.
- The PROTECTIVE EARTH TERMINAL and subsequent protective equipment internal to the equipment shall comply with the requirements in 6.5.2.4 or 6.5.2.5.
- The PROTECTIVE EARTH TERMINAL shall have no other function.

6.5.2.103 Protective earth requirements for OPEN EQUIPMENT

OPEN EQUIPMENT shall comply with the requirements of 6.5.2.4 or 6.5.2.5 with the exception that the provision for connection to an external protective conductor may be replaced by a means for bonding to the ENCLOSURE ACCESSIBLE to the OPERATOR. <http://www.china-gauges.com/>

6.6.1 General

Modification:

Replace NOTE 2 as follows:

NOTE 2 For cord connected MAINS supply, see 6.10.

6.6.2 TERMINALS for EXTERNAL CIRCUITS

Modification:

Add at beginning of the subclause:

All parts of TERMINALS that maintain contact and carry current shall be of metal of adequate mechanical strength.

The mechanical design of the interfaces shall allow that no individual conductor is subjected to bending of a radius of curvature less than six times its diameter after removal of the covering elements (armour, sheaths, fillers).

Conformity is checked by inspection.

CLEARANCES between TERMINALS and TERMINAL to earthed parts are given in 6.7.101.

6.6.3 Circuits with TERMINALS which are HAZARDOUS LIVE

Replacement:

This subclause applies to both TERMINALS and ports (see Table 103).

For ENCLOSED EQUIPMENT no ACCESSIBLE conductive parts may be HAZARDOUS LIVE. For OPEN EQUIPMENT protection for those TERMINALS and ports defined in Table 103 shall be provided.

Conformity is checked by inspection.

6.7.1.1 General

Modification:

Add after the first paragraph:

Insulation requirements between separate circuits and between circuits and ACCESSIBLE conductive parts are specified in Figure 102.

<http://www.china-gauges.com/>

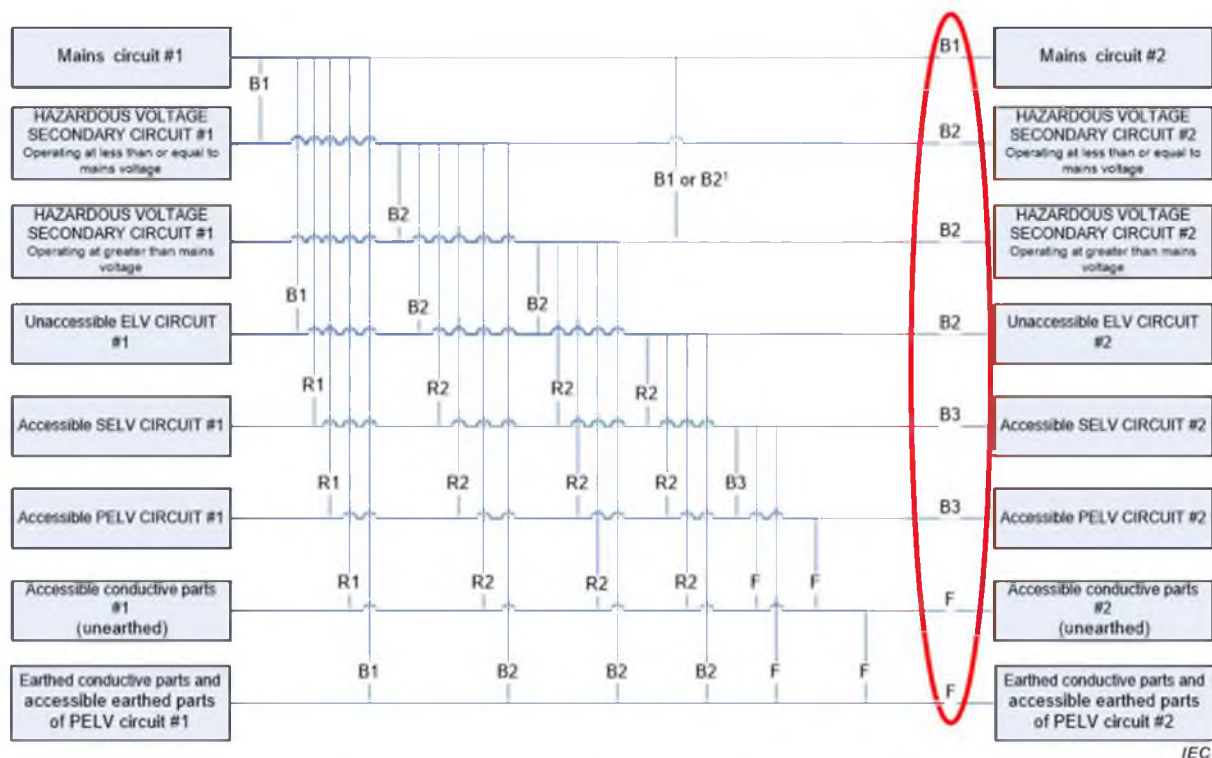

IEC

- B1** Basic level of protection shall meet the requirements of 6.4. Creepage, CLEARANCES, and solid insulation shall meet the requirements of 6.7.2.
- B2** Basic level of protection shall meet the requirements of 6.4. Creepage, CLEARANCES, and solid insulation shall meet the requirements of 6.7.3.
- B3** Basic level of protection shall meet the requirements of 6.4. Creepage, CLEARANCES, and solid insulation shall meet the requirements of 6.7.3. May be waived if fault testing per 4.4 demonstrates no HAZARD occurs.
- R1** Double/reinforced level of protection shall meet the requirements of 6.5. Creepage, CLEARANCES, and solid insulation shall meet the requirements of 6.7.2.
- R2** Double/reinforced level of protection shall meet the requirements of 6.5. Creepage, CLEARANCES, and solid insulation shall meet the requirements of 6.7.3.
- F** Functional insulation. No specific level specified.

Earthed conductive parts – Shall meet the requirements of 6.5.2.4 or 6.5.2.5.

Items circled in red, on right side, may only apply to spread of fire considerations, Clause 9.

¹ The greater of B1 or B2 insulation, depending on the higher of the WORKING VOLTAGES of the MAINS and secondary circuits. <http://www.china-gauges.com/>

Figure 102 – Requirements for insulation between separate circuits and between circuits and ACCESSIBLE conductive parts

Add at the end of the subclause:

Between 1) ACCESSIBLE SELV circuits, 2) ACCESSIBLE PELV circuits or 3) ungrounded conductive ACCESSIBLE parts and HAZARDOUS LIVE parts, there shall be two levels of protection: e.g. a) DOUBLE INSULATION, b) REINFORCED INSULATION, c) BASIC INSULATION + PROTECTIVE BONDING.

6.7.1.2 CLEARANCES

Addition:

Linear interpolation is permitted between the nearest two points in Table 3. The calculated minimum CLEARANCE using this multiplication factor shall be rounded up to the next higher 0,1 mm increment.

6.7.1.5 Requirements for insulation according to type of circuit

Replacement:

Requirements for insulation between separate circuits and between circuits and ACCESSIBLE conductive parts are specified as follows:

- a) in Figure 102;
- b) in IEC 61010-1:2010, Clause K.3 for circuits that have one or more of the following characteristics:
 - 1) the maximum possible TRANSIENT OVERVOLTAGE is limited by the supply source or within the equipment to a known level below the level assumed for the MAINS CIRCUIT;
 - 2) the maximum possible TRANSIENT OVERVOLTAGE is above the level assumed for the MAINS CIRCUIT;
 - 3) the WORKING VOLTAGE is the sum of voltages from more than one circuit, or is a mixed voltage;
 - 4) the WORKING VOLTAGE includes a recurring peak voltage that may include a periodic non-sinusoidal waveform or a non-periodic waveform that occurs with some regularity;
 - 5) the WORKING VOLTAGE has a frequency above 30 kHz;
- c) in IEC 61010-1:2010, Clause K.1 for MAINS CIRCUITS of OVERVOLTAGE CATEGORY III or IV or for OVERVOLTAGE CATEGORY II over 300 V;
- d) in IEC 61010-1:2010, Clause K.2 for secondary circuits separated from the circuits in c) only by means of a transformer.

Requirements for insulation of measuring circuits are specified in IEC 61010-2-030.

NOTE See IEC 61010-1:2010, Clause K.3 for requirements for switching circuits such as a switching power supply.

Add the following subclauses:

6.7.1.101 Non-metallic material supporting HAZARDOUS LIVE parts

Non-metallic material supporting HAZARDOUS LIVE parts shall have a comparative tracking index greater than, or equal to, 175.

6.7.2 Insulation for MAINS CIRCUITS of OVERVOLTAGE CATEGORY II with a nominal supply voltage up to 300 V

<http://www.china-gauges.com/>

Modification:

For MAINS CIRCUITS above 300 V, see Annex K. For Tables K.2, K.3 and K.4, linear interpolation of creepage is allowed, but creepage can never be below CLEARANCE.

6.7.2.1 CLEARANCES and CREEPAGE DISTANCES

Modification:

Replace Table 4 by the following:

Table 4 – CLEARANCE and CREEPAGE DISTANCES for MAINS CIRCUITS of OVERVOLTAGE CATEGORY II up to 300 V

Voltage line-to- neutral AC r.m.s. V ^c	Values for CLEARANCE distances ^d			Values for CREEPAGE DISTANCES ^b								
	POLLUT- ION DEGREE 1	POLLUT- ION DEGREE 2	POLLUT- ION DEGREE 3	POLLUTION DEGREE 1			POLLUTION DEGREE 2			POLLUTION DEGREE 3		
	mm	mm	mm	PWB MG I, II, III mm	MG I, II, III mm	PWB MG I,II,IIIa mm	MG I mm	MG II mm	MG III mm	MG I mm	MG II mm	MG III mm
≤ 50	0,04	0,2 ^a	0,8	0,04	0,18	0,04	0,6	0,85	1,2	1,5	1,7	1,9
≤ 100	0,1	0,2 ^a	0,8	0,1	0,25	0,16	0,71	1,0	1,4	1,8	2,0	2,2
≤ 150	0,5	0,5	0,8	0,5	0,5	0,5	0,8	1,1	1,6	2,0	2,2	2,5
≤ 300	1,5	1,5	1,5	1,5	1,5	1,5	1,5	2,1	3	3,8	4,2	4,7

^a For printed wiring board, the values for POLLUTION DEGREE 1 apply.

^b Linear interpolation of creepage is allowed. But creepage can never be below CLEARANCE.

^c DC or AC peak values are $\sqrt{2} \times$ AC r.m.s. values shown.

^d Interpolation for CLEARANCES is not permitted.

NOTE 1 Table derived from IEC 60664-1.

NOTE 2 MG I = Material group I, CTI ≥ 600.

NOTE 3 MG II = Material group II, 600 > CTI ≥ 400.

NOTE 4 MG IIIa = Material group IIIa, 400 > CTI ≥ 175.

NOTE 5 MG IIIb = Material group IIIb, 175 > CTI ≥ 100.

NOTE 6 MG III = MG IIIa and MG IIIb.

NOTE 7 PWB = Printed wiring board.

NOTE 8 Creepages in this table have already increased so they are not below the CLEARANCE distance.

NOTE 9 For printed wiring boards, 0,04 mm is the minimum CREEPAGE DISTANCE.

Add after the conformity statement:

<http://www.china-gauges.com/>

Since conformity is checked by inspection and measurement, dielectric test is not required.

Add after the last conformity statement:

NOTE 101 See Annex FF for examples of CLEARANCE and CREEPAGE measurement special cases.

6.7.2.2.1 General

Add the following first line:

If MAINS or secondary voltage is greater than 300 V, use Annex K.

Replace Table 5:

Table 5 – Test voltages for solid insulation between MAINS and between MAINS and secondary circuits OVERVOLTAGE CATEGORY II up to 300 V^d

Voltage line-to-neutral AC r.m.s. V ^a	For BASIC INSULATION and SUPPLEMENTARY INSULATION				For REINFORCED INSULATION			
	Test voltages, V				Test voltages, V			
	AC		DC		AC		DC	
	5 s	1 min	5 s	1 min	5 s	1 min	5 s	1 min
≤ 50 ^b	1 250	300	1 750	420	2 500	600	3 500	850
≤ 100 ^c	1 300	350	1 800	500	2 600	700	3 600	990
≤ 150	1 350	400	1 900	570	2 700	800	3 800	1 100
≤ 300	1 500	550	2 100	780	3 000	1 100	4 200	1 600

NOTE Table derived from IEC 60664-1.

^a DC or AC peak values are $\sqrt{2} \times$ AC r.m.s. values shown.
^b For DC products this range ends at 60 V.
^c For DC products this range begins at 60 V.
^d No test is needed for SELV/PELV circuits/units.

Replace the second paragraph on conformity:

Conformity is checked by inspection, and by the AC test of 6.8.3.1, or the DC test of 6.8.3.2, using the applicable voltage from Table 5. Both the 1 min and 5 s test shall be performed or a single test which is the worst case combination of the 1 min and 5 s tests.

NOTE 101 For example, if a 1 min test with 1,1 kV and a 5 s test with 3 kV are required, instead a single test with 3 kV and 1 min is sufficient.

6.7.3.1 General

Modification:

Add at end of paragraph:

For MAINS CIRCUITS above 300 V, see Annex K.

<http://www.china-gauges.com/>

6.7.3.2 CLEARANCES

Modification:

Replace Table 6:

Table 6 – CLEARANCES and test voltages for secondary circuits derived from MAINS CIRCUITS of OVERVOLTAGE CATEGORY II up to 300 V

	MAINS voltage, OVERVOLTAGE CATEGORY II					
	≤100 V AC r.m.s. ^b		≤150 V AC r.m.s. ^b		≤300 V AC r.m.s. ^b	
	RATED impulse voltage 500 V		RATED impulse voltage 800 V		RATED impulse voltage 1 500 V	
Secondary WORKING VOLTAGE V AC r.m.s. ^b	CLEARANCE mm ^a	Test voltage V AC r.m.s.	CLEARANCE mm ^a	Test voltage V AC r.m.s.	CLEARANCE mm ^a	Test voltage V AC r.m.s.
10	0,04	440	0,10	500	0,47	770
12,5	0,04	440	0,10	500	0,47	770
16	0,04	440	0,10	500	0,50	840
33	0,05	455	0,11	510	0,52	850
50	0,05	455	0,12	520	0,53	860
100	0,07	476	0,13	540	0,61	900
150	0,10	507	0,16	580	0,69	940
300	0,24	641	0,39	770	0,94	1 040
600	0,79	980	1,01	1 070	1,61	1 450
1 000	1,66	1 500	1,92	1 630	2,52	1 970
1 250	2,23	1 700	2,50	1 960	3,16	2 280
1 600	3,08	2 200	3,39	2 390	4,11	2 730
2 000	4,17	2 750	4,49	2 890	5,30	3 230
2 500	5,64	3 300	6,02	3 520	6,91	3 850
3 200	7,98	4 000	8,37	4 390	9,16	4 660
4 000	10,6	4 900	10,9	5 320	11,6	5 610
5 000	13,7	6 000	14,0	6 590	14,9	6 960
6 300	17,8	8 000	18,2	8 270	19,1	8 620
8 000	23,5	10 000	23,9	10 400	24,7	10 700
10 000	30,3	12 500	30,7	12 900	31,6	13 300
12 500	39,1	15 800	39,6	16 100	40,5	16 400
16 000	52,0	20 000	52,5	20 400	53,5	20 700
20 000	67,4	25 000	67,9	25 300	68,9	25 600
25 000	87,4	31 300	87,9	31 600	89,0	32 000
32 000	117	40 400	117	40 400	118	40 700
40 000	151	50 300	151	50 300	153	50 800
50 000	196	62 800	196	62 800	198	63 400
63 000	258	79 400	258	79 400	260	80 000

^a Linear interpolation allowed.

^b DC or AC peak values are $\sqrt{2} \times$ AC r.m.s. values shown.

<http://www.china-gauges.com/>

6.7.3.3 CREEPAGE DISTANCES

Modification:

Replace the first column heading of Table 7 of Part 1:

Secondary WORKING VOLTAGE AC. r.m.s V.

Add the following subclause:

6.7.101 Insulation for FIELD WIRING TERMINALS of OVERVOLTAGE CATEGORY II with a nominal voltage up to 1 000 V

Minimum CLEARANCES at FIELD-WIRING TERMINALS from TERMINAL to TERMINAL and from TERMINAL to conductive ENCLOSURE shall comply with the requirements of Table 104.

Minimum CREEPAGE DISTANCES for FIELD WIRING TERMINALS shall be in accordance with Table 104.

Table 104 – Minimum CREEPAGE and CLEARANCE in air of OVERVOLTAGE CATEGORY II up to 1 000 V at FIELD-WIRING TERMINALS^{d, e}

WORKING VOLTAGE AC V r.m.s. V ^c	Termination CLEARANCE mm			Termination CREEPAGE mm	
	General use	Limited RATINGS ^{a, b}	To walls of metallic ENCLOSURES which may be deflected	General use	Limited RATINGS ^{a, b}
≤ 50	1,6	1,6	12	1,6	1,6
≤ 150	3,2	1,6	12	3,2	1,6
≤ 300	3,2	1,6	12	3,2	1,6
≤ 600	6,4	4,8	12	6,4	4,8
≤ 1 000	14	–	14	21,6	–

NOTE Table derived from UL 508, UL 1059 and IEC 61131-2:2007.

^a Applicable to control equipment having ratings not more than 15 A at ≤150 V, 10 A at 151 V – 300 V, or 5 A at 301 V – 600 V.

^b Applicable to control equipment which control more than one load, provided that the total load connected at one time does not exceed 30 A at ≤150 V, 20 A at 151 V – 300 V, or 10 A at 301 V – 600 V.

^c DC or AC peak values are $\sqrt{2} \times$ AC r.m.s. values shown.

^d For OVERVOLTAGE CATEGORY III and IV, Annex K shall be applied.

^e For FIELD WIRING TERMINALS (and connectors) with mixed voltages (e.g. SELV 24 V and 230 V) the larger CLEARANCE and CREEPAGE DISTANCES, for the higher WORKING VOLTAGE between the two, of Table 104 or 6.7.2 shall be utilized.

Conformity is checked by inspection and measurement.

6.10 Connection to the MAINS supply source and connections between parts of equipment

This subclause of Part 1 is only applicable to cord connected MAINS supply.

6.11 Disconnection from supply source

This subclause of Part 1 is not applicable.

NOTE 101 This subclause of Part 1 is not used for this standard. Local practices and codes govern the aspect of installation and use of control equipment.

7 Protection against mechanical HAZARDS

This clause of Part 1 is applicable, except as follows.

Add the following subclause:

7.1.101 OPEN and PANEL MOUNTED EQUIPMENT

OPEN EQUIPMENT is intended to be installed within an ENCLOSURE which protects the OPERATOR from HAZARDS, including mechanical HAZARDS. PANEL MOUNTED EQUIPMENT may be considered as OPEN EQUIPMENT for the portion that is inside the ENCLOSURE, however, the portion of the control equipment that is not inside the ENCLOSURE and is otherwise ACCESSIBLE to an OPERATOR shall be considered to form part of an ENCLOSURE providing protection against potential HAZARDS and shall be evaluated to Clause 7.

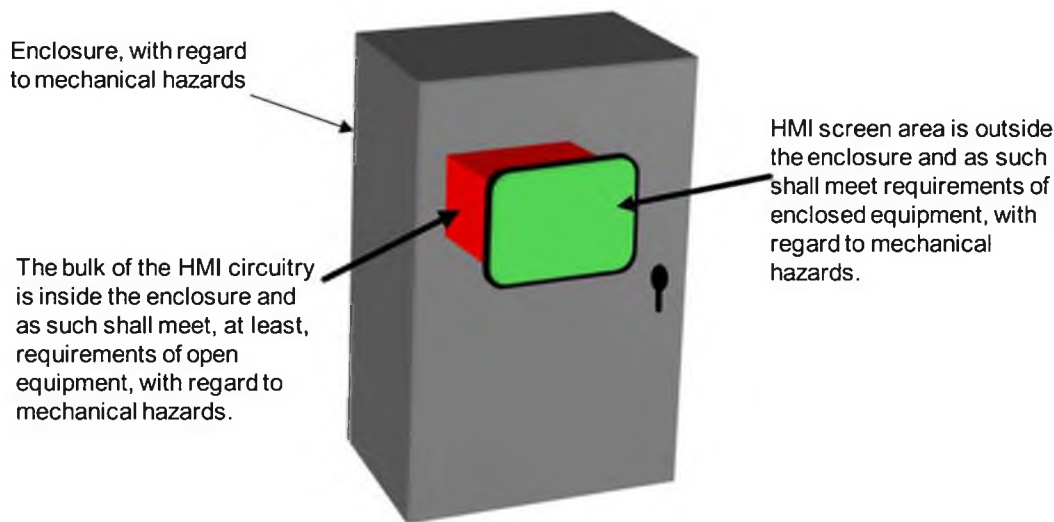

Figure 103 – Mechanical HAZARDS, with regard to PANEL MOUNTED EQUIPMENT

7.2 Sharp edges

Addition :

NOTE 101 Consideration may be given to parts or areas uniquely ACCESSIBLE to SERVICE PERSONNEL. <http://www.china-gauges.com/>

7.3.3 RISK assessment for mechanical HAZARDS to body parts

Modification:

Add after first paragraph but before conformity statement:

If a control equipment has only cooling fans as moving parts, then only a check for accessibility is needed.

7.3.4 Limitation of force and pressure

This subclause of Part 1 is not applicable.

7.3.5 Gap limitations between moving parts

This subclause of Part 1 is not applicable.

7.7 Expelled parts

This subclause of Part 1 is not applicable.

8 Resistance to mechanical stresses

This clause of Part 1 is applicable, except as follows.

8.1 General

Modification:

Replace the second paragraph and its listed points with the following:

The normal energy protection level is $6,8 \pm 5\%$ J.

Add the following subclauses:

8.1.101 OPEN EQUIPMENT

OPEN EQUIPMENT is intended to be installed within another ENCLOSURE which supplies the safety aspects protecting the OPERATOR from HAZARDS.

8.1.102 PANEL MOUNTED EQUIPMENT

PANEL MOUNTED EQUIPMENT may be considered as OPEN EQUIPMENT for the portion that is inside the ENCLOSURE, however, the portion of the control equipment that is not inside the ENCLOSURE and is otherwise ACCESSIBLE to an OPERATOR shall be considered to form part of an ENCLOSURE providing protection against potential HAZARDS and shall be evaluated to Clause 8.

8.2.2 Impact test

Modification:

Replace the fifth paragraph with the following:

Each test point is subjected to one impact by a smooth steel sphere with a diameter of approximately 50 mm. <http://www.china-gauges.com/>

Replace the ninth paragraph (above Figure 10) with the following:

The dimension X and mass are determined by the following equation: $J = X \times m \times g$

$$J = 6,8 \text{ Joules} \pm 5\%$$

$$g = 10 \text{ m/s}^2$$

NOTE 1 Values of the dimension X and mass are approximately 1,3 m and 0,5 kg using this formula.

NOTE 2 Test formula, units, etc. derived from pendulum test method of IEC 60068-2-75.

8.3 Drop test

Addition:

This subclause is applicable for ENCLOSED EQUIPMENT, not for OPEN EQUIPMENT.

9 Protection against the spread of fire

This clause of Part 1 is applicable, except as follows.

9.2 Eliminating or reducing the sources of ignition within the equipment

Modification:

Add to item a) 1):

NOTE Insulation within an energy limited circuit is considered to be functional insulation.

Add to item a) 2), at end of paragraph before conformity statement:

See also Figure 102.

9.3.2 Constructional requirements

Modification:

Add at the beginning of the subclause:

For OPEN EQUIPMENT, items a) and b) apply.

For ENCLOSED EQUIPMENT, a), b) and c) apply.

If the portion of PANEL MOUNTED EQUIPMENT, see Figure 104, that forms a part of the ENCLOSURE in which it is mounted is non-metallic material, it shall have a flame spread RATING of V-1 or better or conformity is tested by the glow wire test described below.

NOTE Example a panel mounted HMI device extending through the wall of a cabinet.

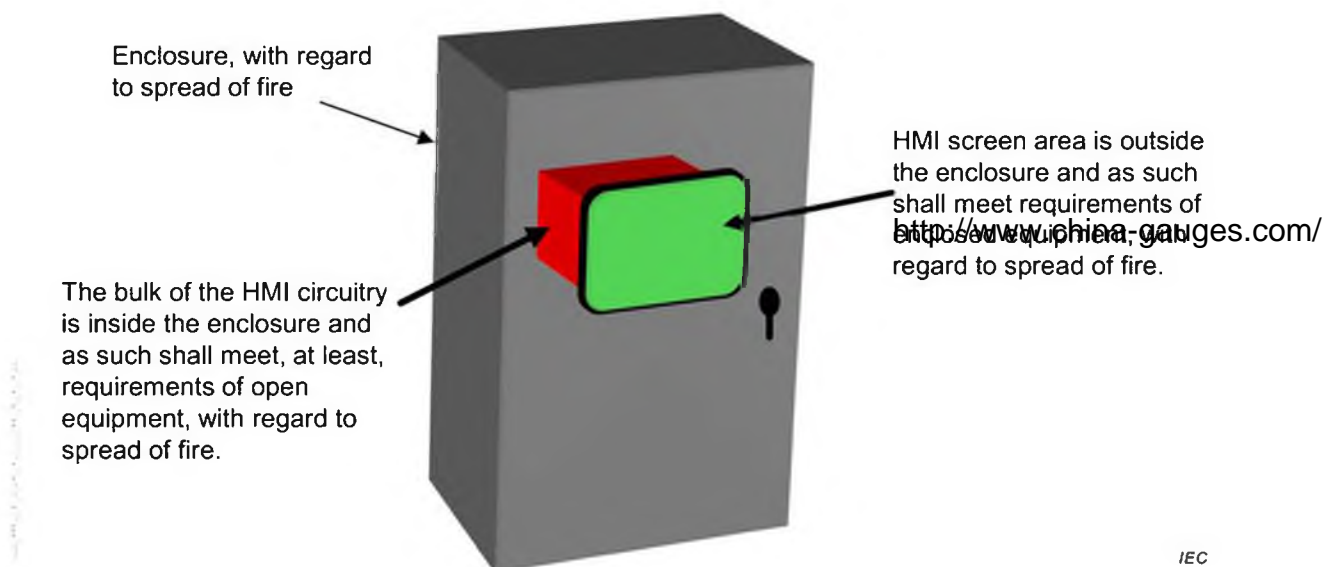

Figure 104 – Spread of fire HAZARDS, with regard to PANEL MOUNTED EQUIPMENT

Non-metallic materials that are not baffles (see IEC 61010-1:2010, Figure 12), flame barriers and do not form a part of the ENCLOSURE require no flame spread RATING.

Add under a) at the end of the conformity statement:

or optionally by a glow-wire test at 750 °C with a 30 s application and an extinguishing time less than, or equal to, 30 s according to IEC 60695-2-11.

Replace item c) 2) by the following text:

The ENCLOSURE and any baffle or flame barrier shall be made of metal or of non-metallic materials having a flammability classification of V-1 or better, of IEC 60695-11-10. If magnesium alloy is used for the ENCLOSURE or a flame barrier it shall be verified as specified in Annex DD.

Replace the conformity statement after item 3) with the following:

Conformity is checked by inspection. If the ENCLOSURE or flame barrier is made of magnesium alloy, the flammability test of requirement c) 2) is checked as specified in Annex DD. In other cases of doubt, the flammability classification of requirement c) 2) is checked by performing the vertical burning test of IEC 60695-11-10 on samples of the material used in the relevant parts.

10 Equipment temperature limits and resistance to heat

This clause of Part 1 is applicable, except as follows.

10.1 Surface temperature limits for protection against burns

Modification:

Replace Table 19:

Table 19 – Surface temperature limits, under NORMAL CONDITION

Part	ENCLOSED EQUIPMENT °C	OPEN EQUIPMENT °C
1 Outer surface of ENCLOSURE or barrier (unintentional contact)		
a) metal uncoated or anodized	65	70
b) metal coated (paint, non-metallic)	80	85
c) plastics	85	85
d) glass and ceramics	80	85
e) small areas (< 2 cm ²) that are not likely to be touched in NORMAL USE	100	100
2 Knobs and handles (NORMAL USE contact)		
a) metal	55	55
b) plastics	70	70
c) glass and ceramics	65	70
d) non-metallic parts that in NORMAL USE are held only for short periods (1 s-4 s)	70	85
NOTE 1 NORMAL USE contact could be surfaces touched by an OPERATOR in NORMAL USE or by SERVICE PERSONNEL.		
NOTE 2 This table is based on IEC Guide 117:2010.		

For equipment with ambient temperature ratings above 40C, higher temperatures are possible. See clause 10.1 of IEC 61010-1:2010. See 5.4.4 item j).

10.3 Other temperature measurements

Modification:

Add at the end of item a):

This does not apply to control equipment FIELD WIRING, e.g. I/O's or to TERMINAL boxes for control equipment FIELD WIRING which do not contain power consuming parts.

Add item f):

FIELD WIRING TERMINALS' temperature shall be monitored during the temperature test. This data shall be used in conjunction with the device's RATED AMBIENT TEMPERATURE to determine the FIELD WIRING insulation temperature requirements.

10.4.1 General

Replace this subclause of Part 1 as follows:

10.4.1.100 General method

Equipment under test (EUT) shall be tested under reference test conditions. The reference test AMBIENT TEMPERATURE shall be the same as the maximum RATED AMBIENT TEMPERATURE, as defined in IEC 61010-1:2010, 1.4.1 c) or 1.4.2.c).

NOTE 1 RATED AMBIENT TEMPERATURE may be referenced in other terminology, e.g. RATED operating temperature, or designation, such as Ta.

Unless a particular SINGLE FAULT CONDITION specifies otherwise, the manufacturer's instructions concerning ventilation, cooling liquid, limits for intermittent use, etc. are followed. Any cooling liquid shall be at the highest RATED temperature.

The EUT shall be mounted in its least favourable position/orientation.

The EUT shall be generating its least favourable heat dissipation. This dissipation may be caused by some combination of load current, input voltage, input frequency, I/O duty cycle, etc.

EUT FIELD WIRING shall be the smallest size suitable for the maximum current RATING of the EUT according to manufacturer's instructions. <http://www.china-gauges.com/>

The test room/chamber/box (size is not a test criteria) environment surrounding the EUT shall not be subject to air movement caused by sources not part of the EUT, i.e. it shall be a natural convection environment. See Figure 105.

NOTE 2 To reduce and block forced air movement in a test room or in a climatic chamber around the EUT, the EUT can be placed in a partially or completely closed test box allowing air movement / natural convection only caused by the EUT. Or barriers made of any suitable material could be used around the EUT, to block air movement.

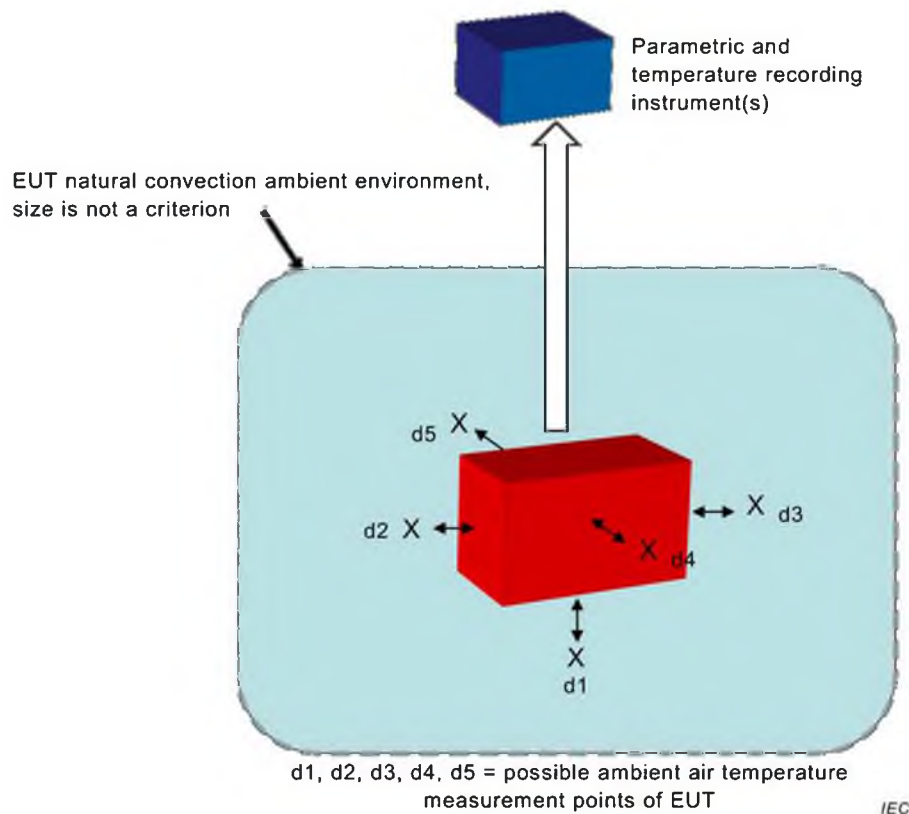

Figure 105 – General temperature test environment

Temperatures are measured when steady state has been reached.

If the EUT is meant to function as a standalone unit it shall be tested standalone, e.g. a standalone HMI or communications switch/router.

If the EUT is not meant to function as a standalone unit, e.g. I/O module of a MODULAR EQUIPMENT system, then a representative system shall be utilized for testing. This system shall represent a practical least favourable combination of conditions for the EUT.

NOTE 3 Practical least favourable combination of conditions means a realistic situation the EUT can be utilized for in a real world application, not a theoretical combination which would never be used in practice.

This practical least favourable combination shall be, at a minimum, the items necessary for the EUT to function, e.g. power supply, communication module (TM's in Figure 106) and EUT. The EUT shall be surrounded, as permitted by manufacturer's documentation, on both sides with real modules or "simulation modules" (thermally representative modules, TM's in Figure 106) representing the worst case thermal environment for the EUT, i.e. adding more modules around the EUT does not cause further temperature increase of the EUT. A justification of the configuration for the test shall be provided in the test report.

An example configuration for testing an I/O module EUT, of a modular system, might be:

- *the EUT (I/O module),*
- *a power supply,*
- *communication module,*
- *three of the same type I/O module operating at full load to the left of the EUT,*
- *three of the same type I/O module operating at full load to the right of the EUT, and*
- *adding more I/O modules left or right does not cause the EUT's temperature to change.*

For vented equipment, cooled by natural air convection, the AMBIENT TEMPERATURE is the incoming air temperature at a point not more than 50 mm and not less than 25 mm away from the plane of the equipment's air flow entry point. See Figure 106. The points d1, d2 and d3, in Figure 106, are the possible measurement points. The point with the lowest temperature should be utilized as the AMBIENT TEMPERATURE.

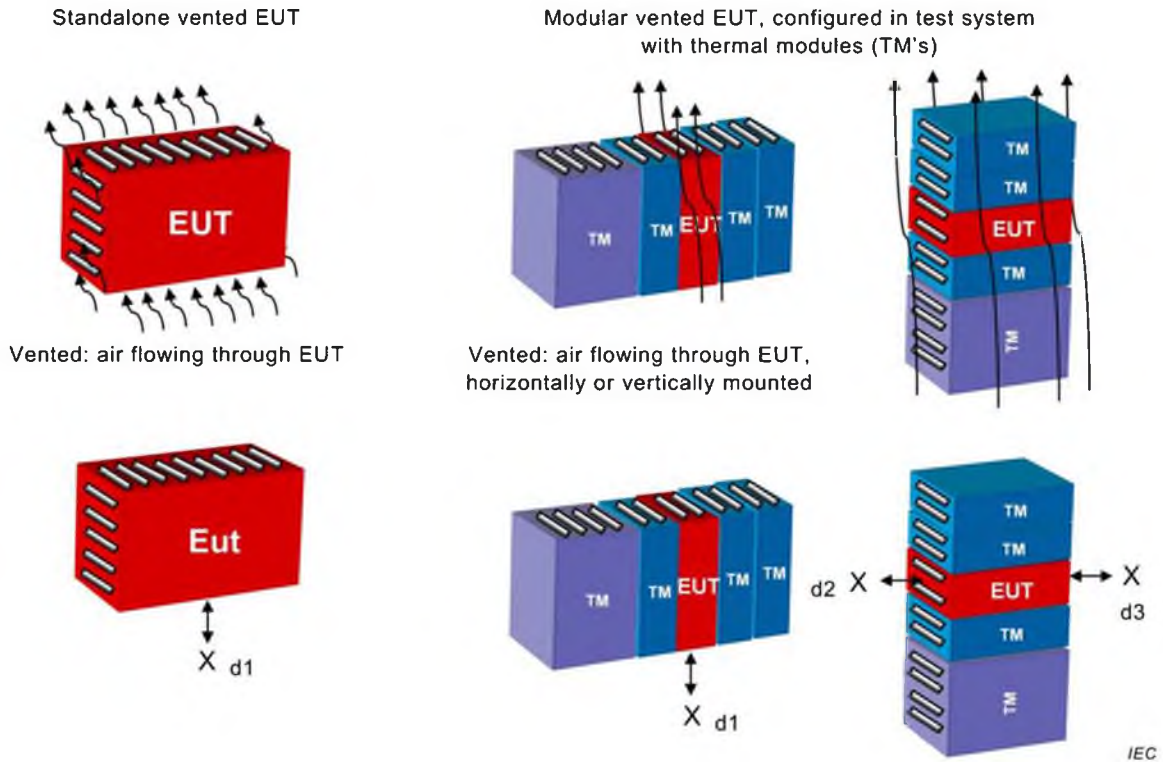

Figure 106 – Vented equipment

NOTE 4 Vents are purposeful air openings intended to allow air to pass through the equipment for the purpose of cooling, not incidental vents, e.g. switch shaft or communication jack openings.

For non-vented equipment, cooled by natural air convection, the AMBIENT TEMPERATURE is the air temperature at a point not more than 50 mm and not less than 25 mm away from the equipment, on a horizontal plane located at the vertical mid-point of the equipment. See Figure 107. The points d2-d5 in Figure 107 are the possible measurement points. The point with the lowest temperature should be utilized as the AMBIENT TEMPERATURE.

Due to mounting requirements, some of the measurement points may not be practical to utilize.

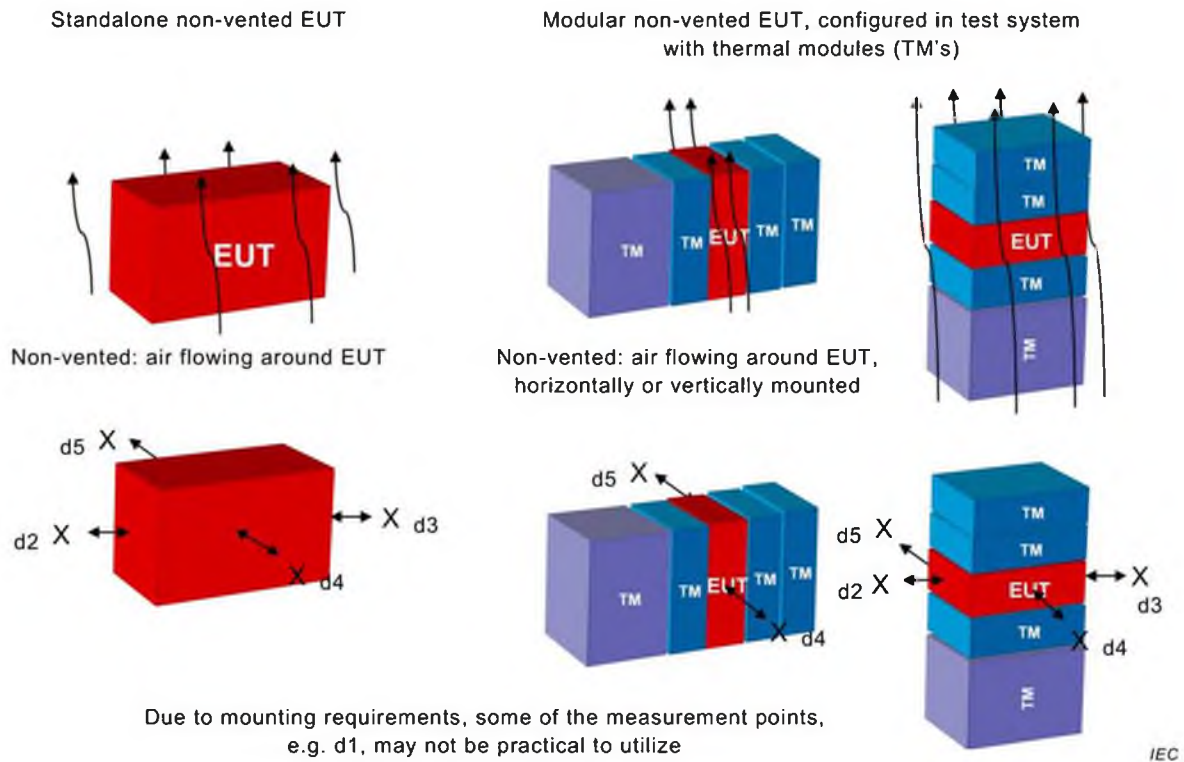

Figure 107 – Non-vented equipment

10.4.1.101 Special method, PANEL MOUNTED EQUIPMENT

PANEL MOUNTED EQUIPMENT presents some special considerations, see Figure 108.

In this case part of the equipment (EUT_a) may be in one ambient environment, e.g. ambient environment #1 and the rest of the equipment (EUT_b) may be in another ambient environment, e.g. ambient environment #2. The equipment construction techniques can be quite different, e.g. (referring to Figure 108) open/vented in ambient environment #1 and enclosed/non-vented in ambient environment #2.

It should be kept in mind, it may be necessary that these two different environments be applied simultaneously, to ensure least favourable conditions.

<http://www.china-gauges.com/>

Each part of the equipment (EUT_a and EUT_b) shall be evaluated separately according to its own environment.

The general method described in 10.4.1.100 with regard to test conditions and least favourable EUT configuration, orientation, etc. shall be followed.

Three special methods for testing PANEL MOUNTED EQUIPMENT are provided:

- a) *The equipment shall be mounted such that the two portions (EUT_a and EUT_b) of the EUT are subjected to their specific environments.*

NOTE 1 This provides the most accurate results, but is the most difficult to create for a test.

- b) *The total EUT ($EUT_a + EUT_b$) shall be mounted in a single environment, which shall be the higher RATED temperature of the two, and the recorded temperatures of the lower RATED temperature EUT portion are corrected by the difference between the EUT's maximum RATED AMBIENT TEMPERATURE and the actual test AMBIENT TEMPERATURE.*

EXAMPLE: If EUT_a's maximum RATED AMBIENT TEMPERATURE = 60 °C and EUT_b's maximum RATED AMBIENT TEMPERATURE = 50 °C, the test shall be run with a test AMBIENT TEMPERATURE = 60 °C. Temperatures taken for EUT_b would be corrected by -10 °C (50 °C - 60 °C).

NOTE 2 This method is not as accurate as a) but will yield conservative results compared to c).

- c) *The total EUT (EUT_a + EUT_b) shall be mounted in a single environment, which shall be the lower RATED temperature of the two, and the recorded temperatures of the higher RATED temperature EUT portion are corrected by the difference between the EUT's maximum RATED AMBIENT TEMPERATURE and the actual test AMBIENT TEMPERATURE.*

EXAMPLE: If EUT_a's maximum RATED AMBIENT TEMPERATURE = 60 °C and EUT_b's maximum RATED AMBIENT TEMPERATURE = 50 °C, the test shall be run with a test AMBIENT TEMPERATURE = 50 °C. Temperatures taken for EUT_a would be corrected by +10 °C (60 °C - 50 °C).

NOTE 3 This method is not as accurate as a) and will not yield conservative results compared to b).

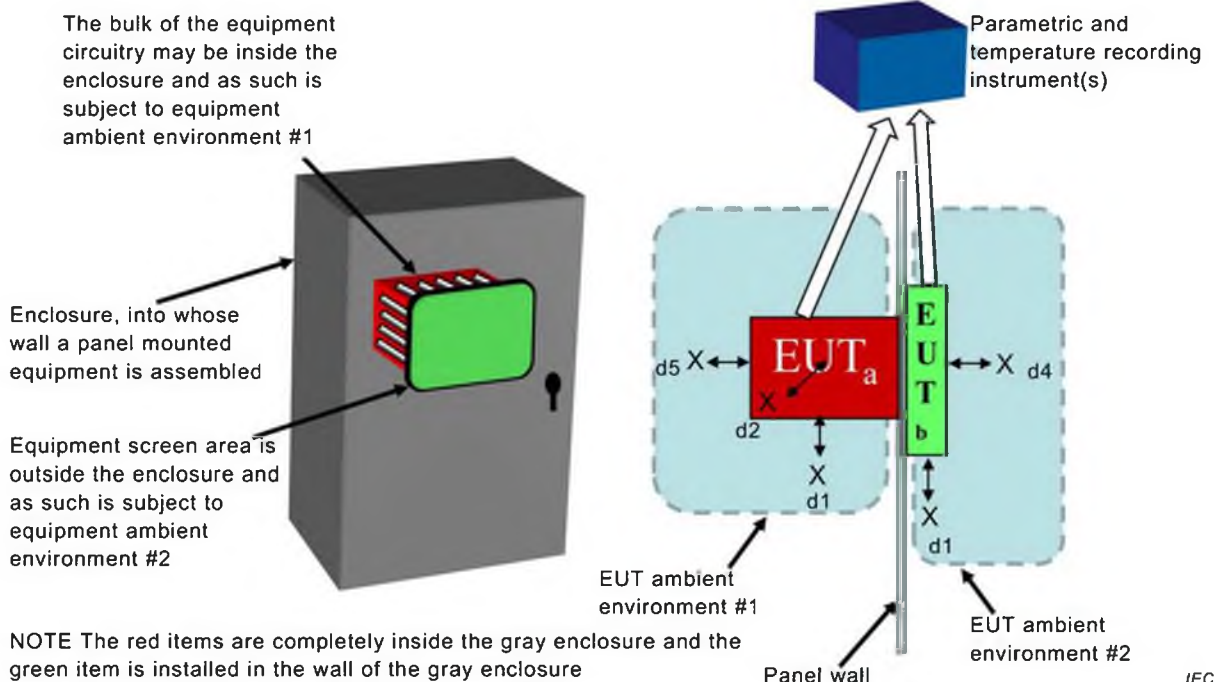

Figure 108 – Panel mounted device extending through the wall of a cabinet

10.4.1.102 Special method, large or heavy equipment

<http://www.china-gauges.com/>

Equipment too large or too heavy can be tested at room AMBIENT TEMPERATURE, if the recorded temperatures are corrected by the difference between the EUT's maximum RATED AMBIENT TEMPERATURE and the actual test room AMBIENT TEMPERATURE.

Where this method is applied, rationale shall be provided in the test report.

10.4.1.103 Other considerations, applying to all cases

Other considerations for temperature testing:

- The temperature of insulating material of windings is measured as the temperature of winding wire and of core lamination in contact with the insulating material. It can be determined by the resistance method or by using temperature sensors selected and positioned so that they have a negligible effect on the temperature of the winding. The latter method may be used if the windings are non-uniform or if it is difficult to measure resistance.
- Due to the difficulty of setup and repeat for single fault tests, these tests can be done at room AMBIENT TEMPERATURE. The recorded temperatures shall be corrected by the

difference between the EUT's maximum RATED AMBIENT TEMPERATURE and the actual test room AMBIENT TEMPERATURE.

10.4.2 Temperature measurement of heating equipment

This subclause of Part 1 is not applicable.

10.5.2 Non-metallic ENCLOSURES

Modification:

Add at the beginning of the subclause:

This subclause is applicable for ENCLOSED EQUIPMENT.

11 Protection against HAZARDS from fluids

This clause of Part 1 is applicable, except as follows.

11.6 Specially protected equipment

Replacement:

If the equipment is rated and marked by the manufacturer as conforming to a stated degree of protection, e.g. from IEC 60529, it shall resist the entry of fluids and other material to the extent specified.

Conformity is checked 1) by inspection or 2) by subjecting the equipment to the appropriate treatment, e.g. of IEC 60529, after which the CLEARANCES and solid insulation shall pass the voltage tests of 6.8 (without humidity preconditioning) applicable to the type of insulation (see 6.7) and ACCESSIBLE parts shall not exceed the limits of 6.3.1. If there is any doubt, 2) shall be applied.

12 Protection against radiation, including laser sources, and against sonic and ultrasonic pressure

This clause of Part 1 is applicable.

<http://www.china-gauges.com/>

13 Protection against liberated gases and substances, explosion and implosion

This clause of Part 1 is applicable, except as follows.

13.1 Poisonous and injurious gases and substances

This subclause of Part 1 is not applicable.

13.2.1 Components

This subclause of Part 1 is not applicable.

13.2.2 Batteries and battery charging

Addition:

NOTE For batteries and battery packs the following standards can additionally apply: IEC 62133 (battery packs), UL 1642 (lithium batteries), UL 2054 (rechargeable batteries).

14 Components and subassemblies

This clause of Part 1 is applicable, except as follows.

Add the following subclauses:

14.101 Components bridging insulation

14.101.1 Capacitors

A capacitor connected between two line conductors in a MAINS CIRCUIT, or between one line conductor and the neutral conductor shall comply with subclass X1 or X2 of IEC 60384-14.

A capacitor between the MAINS CIRCUIT and protective earth shall comply with subclass Y1, Y2 or Y4 of IEC 60384-14.

A capacitor bridging DOUBLE INSULATION or REINFORCED INSULATION in the control equipment shall comply with subclass Y1 or Y2 of IEC 60384-14.

In all cases a capacitor shall be used in accordance with its RATING.

These requirements do not apply to a capacitor connected between a hazardous voltage secondary circuit and protective earth, where only BASIC INSULATION is required.

Capacitors in conformity with IEC 60384-14 and approved by a recognized testing authority may be removed from the circuit for the high-voltage TYPE TEST.

NOTE Removal from the circuit is allowed, when the value of the required voltage test is higher than the rated value of the capacitor.

Compliance is checked by inspection.

14.101.2 Surge suppressors

It is permitted to use any type of surge suppressor, including a voltage dependent resistor (VDR, also known as MOV), in a secondary circuit.

NOTE 1 It is not a requirement of this standard to comply with any particular component standard for surge suppressors used in secondary circuits. However, attention is drawn to the IEC 61643 series of standards, in particular:

<http://www.china-gauges.com/>

- IEC 61643-21 (surge suppressors in telecommunications application),
- IEC 61643-311 (gas discharge tubes),
- IEC 61643-321 (avalanche breakdown diodes),
- IEC 61643-331 (metal oxide varistors).

If a surge suppressor is used in a MAINS CIRCUIT, it shall be a VDR and it shall comply with IEC 61051-2.

NOTE 2 A VDR is sometimes referred to as a varistor or a metal oxide varistor (MOV). Devices such as gas discharge tubes, carbon blocks and semiconductor devices with non-linear voltage/current characteristics are not considered as VDRs in this standard.

Conformity is checked by inspection.

14.102 Switching devices

This subclause is only applicable to switching devices with a RISK of fire or shock.

Switching devices controlling outputs shall be used within their RATINGS, according to IEC 60947-5-1, or equipment utilizing them shall be subjected to the overload and endurance tests specified in 4.4.2.101.1 and 4.4.2.101.2, respectively. The same sample shall be subjected first to the overload test and then the endurance test. The test specified in 6.7.2.2.1 shall immediately follow the endurance test or the overload test when conducted alone.

The endurance test need not be conducted on solid-state output devices for general or resistive use.

15 Protection by interlocks

This clause of Part 1 is not applicable.

16 HAZARDS resulting from application

This clause of Part 1 is applicable.

17 RISK assessment

This clause of Part 1 is applicable.

<http://www.china-gauges.com/>

Annexes

All annexes of Part 1 are applicable, except as follows:

<http://www.china-gauges.com/>

Annex E (informative)

Guideline for reduction of POLLUTION DEGREES

Replacement:

The micro-environment inside the equipment is determined by the environmental conditions to which the equipment is exposed during operation, installation, maintenance, and any POLLUTION generated by the equipment itself as well as by the effectiveness of applied sealing measures.

Equipment can be divided into environmental situations as depicted in Table E.1.

Table E.1 – Environmental situations

Environmental situation	Equipment operated in ...	Installation or maintenance of equipment in ...
A	controlled environment ^a	controlled environment
B	uncontrolled environment	controlled environment or equipment is not opened during installation or maintenance
C	uncontrolled environment	uncontrolled environment
^a A controlled environment is an environment having the conditions of IEC61010-1:2010, 1.4.1 c) and d).		

NOTE The environmental situation of Table E.1 provides a systematic classification of the environments to which the equipment is exposed and whether the equipment may be opened for installation and maintenance purposes.

Reduction of the POLLUTION DEGREE of the micro-environment may be achieved by the methods of Table E.2. The POLLUTION DEGREE may not be reduced when the equipment is subject to condensation or it produces pollutants itself.

<http://www.china-gauges.com/>

Table E.2 – Reduction of POLLUTION DEGREES (PD)

	Original POLLUTION DEGREE						
	2			3		4	
	Environmental situation (Table E.1)						
	A	B	C	B	C	B	C
Additional Protection	Protection Degree with additional protection						
ENCLOSURE IPx4	--	--	--	--	--	--	--
ENCLOSURE IPx5, IPx6	1	--	--	--	--	--	--
ENCLOSURE IPx7, IPx8	1	1	--	2 ^{a,b}	--	2 ^{a,b}	--
Constant heating within the equipment with an ENCLOSURE of IPx4 or higher	1	--	--	--	--	--	--
Hermetically sealed ENCLOSURE	1	1	1	1	1	1	1
NOTE 1 Reduction maximum to PD 1.							
NOTE 2 PD 3 and PD 4 not considered as controlled environment.							
NOTE 3 Reduction measures are meant as alternatives.							
NOTE 4 IP classification based on IEC 60529.							
^a Conformal coating, further 1 POLLUTION DEGREE reduction							
^b Potting or encapsulation, further 1 POLLUTION DEGREE reduction							
-- = no reduction							

NOTE Examples how to use the tables:

- 1) Equipment in an external environment of PD = 2 and environmental situation = B protected by an ENCLOSURE IPx7 or IPx8 gets a reduction to PD = 1.
- 2) Equipment in an external environment of PD = 3 and environmental situation = B protected by an ENCLOSURE IPx7 or IPx8 gets a reduction to PD = 2, and with additional protection by conformal coating gets a reduction to PD = 1.

<http://www.china-gauges.com/>

Annex F (normative)

ROUTINE TESTS

This annex of Part 1 is applicable, except as follows.

F.2 Protective earth

Modification:

Add between the paragraph and the NOTE:

The resistance shall not exceed 0,1 Ω .

F.3.1 General

Addition:

No test is required for supply voltages equal to or below those specified in IEC 61010-1:2010, 6.3.1, a).

F.4 Floating circuits

Addition:

No test is required for supply voltages equal to or below those specified in IEC 61010-1:2010, 6.3.1, a).

Add the following clause:

F.101 Supply circuits other than MAINS and floating circuits

These are supply circuits other than those defined in Clause F.3 and F.4.

A test voltage is applied between

<http://www.china-gauges.com/>

- a) the supply circuit, and
- b) all input and output TERMINALS of all other circuits which have to be isolated from the supply circuit in a), connected together.

During this test, the control equipment shall be electrically isolated from any external earth.

This test is not applied to small metal parts e.g. name plates, screws or rivets, since they are not normally connected to any circuit.

The test voltage may be AC or DC or impulse, and is selected from IEC 61010-1:2010, Table F.1 for the appropriate OVERVOLTAGE CATEGORY. For the AC and DC tests, the test voltage is raised to its specified value within 5 s, and maintained for at least 2 s. Impulse tests are the 1,2/50 μ s test specified in IEC 61180, conducted for a minimum of three pulses of each polarity at 1 s minimum intervals.

No flashover of CLEARANCES or breakdown of solid insulation shall occur during the test, nor shall the test device indicate failure.

No test is needed for SELV/PELV circuits/units.

No test is required for supply voltages equal to or below those specified in IEC 61010-1:2010, 6.3.1, a).

<http://www.china-gauges.com/>

Annex L
(informative)

Index of defined terms

This annex of Part 1 is not applicable.

See Clause 3 of Part 1 and Clause 3 of this standard for a complete set of defined terms.

<http://www.china-gauges.com/>

Annex AA (informative)

General approach to safety for control equipment

AA.1 Personnel

AA.1.1 General

There are two types of persons whose safety needs to be considered, OPERATORS and SERVICE PERSONNEL. Figure AA.1 depicts the general situation.

NOTE SERVICE PERSONNEL is described in 3.113.

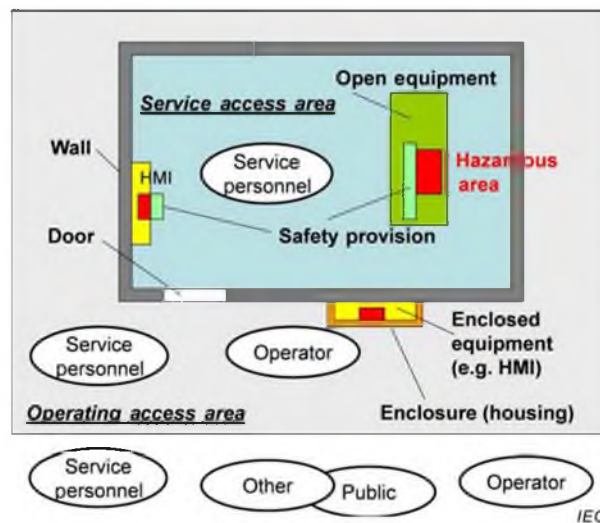

Figure AA.1 – Control equipment access and safety concerns

AA.1.2 OPERATOR

OPERATOR is the term applied to all persons other than SERVICE PERSONNEL. Requirements for protection should assume that OPERATORS are not trained to identify HAZARDS, but will not intentionally create a hazardous situation. Consequently, the requirements will provide protection for cleaners and casual visitors as well as the assigned <http://www.chinagauge.com/> OPERATORS should not have access to hazardous parts, and to this end, such parts should only be in service access areas or in ENCLOSED EQUIPMENT located in operating access areas.

AA.1.3 SERVICE PERSONNEL

SERVICE PERSONNEL are expected to use their training and skill to avoid possible injury to themselves and others due to obvious HAZARDS that exist in service access areas of the control equipment or on ENCLOSED EQUIPMENT located in operating access areas. However, SERVICE PERSONNEL should be protected against unexpected HAZARDS.

This can be done by, for example:

- locating parts that need to be ACCESSIBLE for servicing away from areas with electrical and mechanical HAZARDS;
- providing shields to avoid accidental contact with hazardous parts;
- providing interlocks as protection against HAZARDS;
- providing labels or instructions to warn personnel about any residual RISK.

Information about potential HAZARDS can be marked on the control equipment or provided with the control equipment, depending on the likelihood and severity of injury, or made available for SERVICE PERSONNEL. In general, OPERATORS shall not be exposed to HAZARDS likely to cause injury, and information provided for OPERATORS should primarily aim at avoiding misuse and situations likely to create HAZARDS, such as connection to the wrong power source and replacement of fuses by incorrect types.

Local requirements may specify that SERVICE PERSONNEL need to be licensed or certified for the equipment they service.

AA.2 Operating access areas

This is meant as the control equipment location. SERVICE PERSONNEL have access to these areas and OPERATORS may be allowed depending on the level of training or instruction necessary for access. This could be a room or a cabinet, as examples.

AA.3 Service access areas

These are areas of the control equipment where service tasks are expected to be performed, i.e. changing fuses, batteries, cleaning filters, performing isolation tests. Only SERVICE PERSONNEL have access. This could be a room or a cabinet, as examples. These areas are normally secured.

AA.4 Equipment types

AA.4.1 General

Two types of control equipment are available. These have different constructional requirements. These are meant for use by different personnel and/or installation in different areas. These two control equipment types are OPEN and ENCLOSED EQUIPMENT.

AA.4.2 OPEN EQUIPMENT

OPEN EQUIPMENT is meant for access only by SERVICE PERSONNEL. It provides protection for SERVICE PERSONNEL against unintentional contact with:

- a) unexpected HAZARDOUS LIVE parts;
- b) unexpected hot surfaces, as opposed to expected hot surfaces such as heat sinks and semiconductors;
- c) unexpected mechanical HAZARDS, such as sharp edges, protruding wires and screws, as opposed to expected mechanical hazards such as fans.

AA.4.3 ENCLOSED EQUIPMENT

ENCLOSED EQUIPMENT is meant for access by an OPERATOR. It provides protection for the OPERATOR in NORMAL CONDITION and SINGLE FAULT CONDITION against:

- a) contact with HAZARDOUS LIVE parts;
- b) hot surfaces;
- c) mechanical HAZARDS.

NOTE The ENCLOSURE can be used to prevent spread of fire, from the ENCLOSED EQUIPMENT, if the ENCLOSURE is designed for that purpose.

Annex BB (informative)

System drawing of isolation boundaries

BB.1 General

The intent of Annex BB is to foster a consistent use of this standard by designers and certifiers.

One concept discussed is a kind of system drawing, which can be used to understand and communicate the electrical safety and isolation in a system as it is developed. This drawing can then help inform future designers and certification parties, working on the system, of the concepts originally set down.

This annex will focus on OPEN EQUIPMENT. The figures shown in this Annex BB are examples and serve for illustration of the text.

BB.2 Installation environment of OPEN control equipment

Figure BB.1 depicts an example of a typical ENCLOSURE. The ENCLOSURE contains multiple items which comprise parts of the overall automation system.

The incoming circuit breakers/disconnects are shown near the top of the ENCLOSURE. This may be the factory three phase distribution AC power, e.g. 480 V AC. Next to this is a control transformer. This is used to step down the factory power to local control power, e.g. 480 V AC three phase to single phase 120 V AC.

The system power supply, which utilizes the local control power to provide control equipment power, e.g. 24 V DC is located to the left of the control transformer. Located close by these items, would be power distribution circuit breakers and TERMINALS so as to distribute the local control and control equipment power within the ENCLOSURE. Note these items are normally located near the top of the ENCLOSURE to keep their heat production from affecting more heat sensitive equipment below.

Located on the right side of the ENCLOSURE are a set of PWM drives, which are not the subject of this standard, see IEC 61800 series. However it is typical to see such an automation system configuration. <http://www.china-gauges.com/>

More sensitive equipment (sensitive from a temperature and/or of EMC noise perspective) is normally located near the bottom of the ENCLOSURE.

The subject of this standard, control equipment, is located at the left centre. It is more temperature and noise tolerant, but not as insensitive as those items near the top of the ENCLOSURE.

Note the wireway organization. It is laid out to segregate wiring by type; e.g. high power, higher voltage, noise prone wiring in the black wireway and low power, low voltage, low noise wiring in the shaded wireway. Note also the noise barrier where it is necessary for high power/noise and low power/noise wiring to be in close proximity.

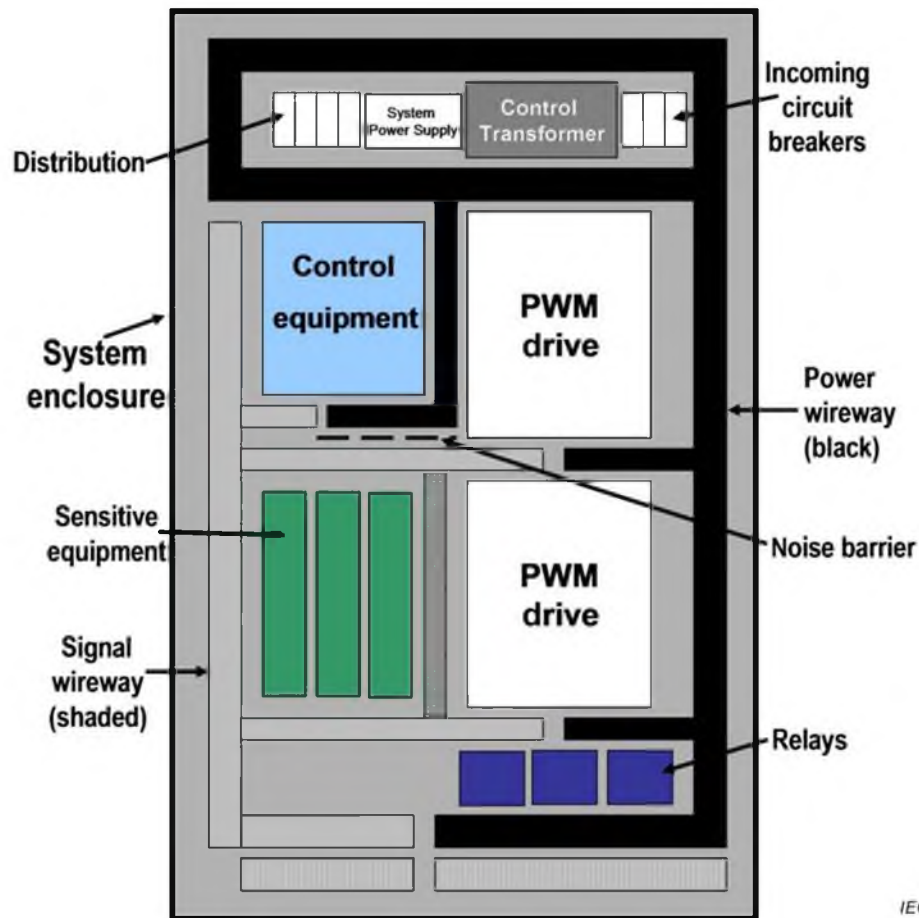

Figure BB.1 – Typical system ENCLOSURE layout

BB.3 Control equipment electrical safety drawing

Utilizing the general layout just discussed, and focusing on the control equipment, it is possible to create a generalized schematic of the environment in which the control equipment resides. Figure BB.2 represents an example schematic for what might be called a control equipment electrical safety drawing.

This diagram can provide a key item in the design of any control system the environment and the method by which that system will achieve its electrical safety. <http://www.china-gauges.com/>

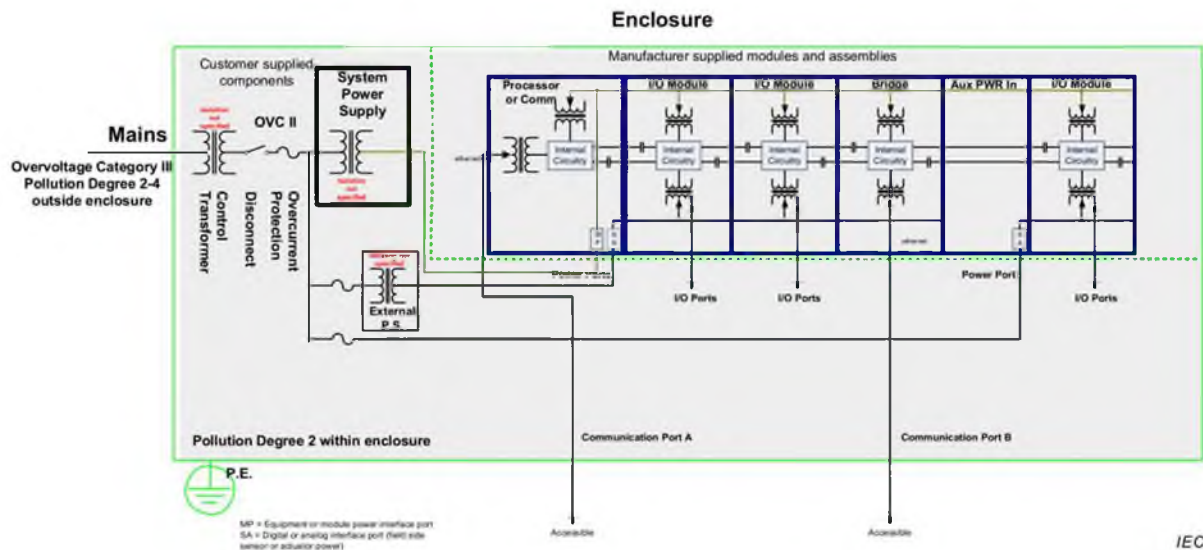

Figure BB.2 – Simplified system schematic

The control equipment, which is being designed, is within the dashed green box and referred to as "manufacturer supplied modules and assemblies". This is the equipment being designed with the help of this standard. As this example is a modular system, a number of example modules, e.g. processor or communication module, I/O module, bridge (another type of communication module) and a power input module are shown. Many other types of modules are possible. See Figure 101.

Since this example is OPEN EQUIPMENT, it is shown housed inside the ENCLOSURE. This is generally a larger ENCLOSURE into which many different equipment items are housed. See Figure BB.1.

The two lines exiting the ENCLOSURE, in Figures BB.2 to BB.11, are communications lines normally ACCESSIBLE by personnel, e.g. OPERATORS, or interfaced to other equipment, e.g. PWM drives. As these items could be ACCESSIBLE by OPERATORS, protection is provided. See communication ports e.g. Ar, Be or E on Figure 101 and Table 103.

Each of the modules e.g. processor or communication module, I/O module, bridge and auxiliary power input module may have other ports where connection is made to the module. I/O ports are shown in the schematic, e.g. C or D Figure 101 and Table 103. <http://03.anchina-gauges.com/> are also shown, e.g. F or J on Figure 101 and Table 103.

At the top of each module a transformer is shown. This is used to schematically indicate isolation between power entering at the top and the "internal circuitry" fed from the transformer. Similarly at the bottom of side of each module is another transformer symbol. Again this indicates the isolation between the "internal circuitry" and the power and circuitry which may be on the opposite side.

"Internal circuitry" is that circuitry, e.g. microprocessor or memory, which is internal to the module and sits inside a sort of isolation island formed by the indicated transformers. Hence it could be said the internal circuitry is isolated from the outside world.

Figure BB.3 depicts two example situations for the safety aspects provided in the example above.

Following the blue lightning bolts, representing a hazardous voltage, the voltage is shown entering a power port. If there are failures of the processor module isolation devices or they

do not exist, then the person working on the communication port A will be exposed to the hazardous voltage.

Similarly, again referring to Figure BB.3, following the red lightning bolts, also representing a hazardous voltage, the voltage shown entering a different power port. If there are failures of the I/O module and bridge isolation devices or they do not exist, then the person working on the Communication Port B will be exposed to the hazardous voltage.

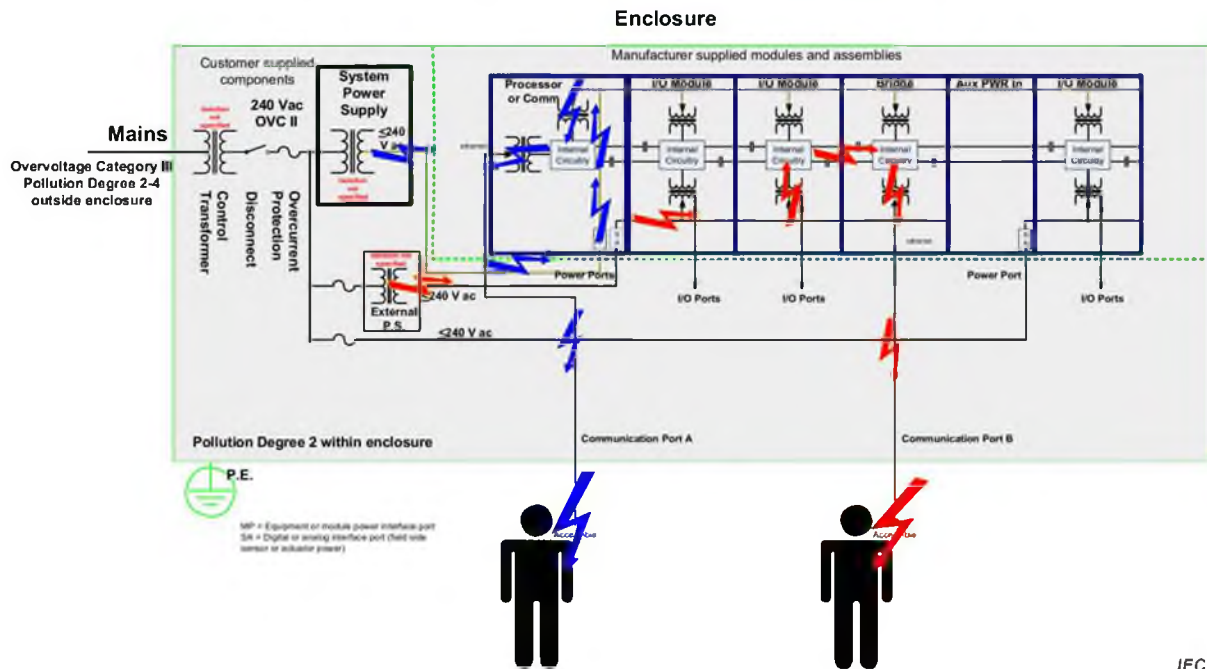

Figure BB.3 – HAZARD situation of the control equipment

BB.4 Applying the standard to the control equipment electrical safety drawing

Figure BB.4, Figure BB.5 and Figure BB.6 provide a reference for which clauses of this standard apply to which areas of the control equipment electrical safety drawing.

<http://www.china-gauges.com/>

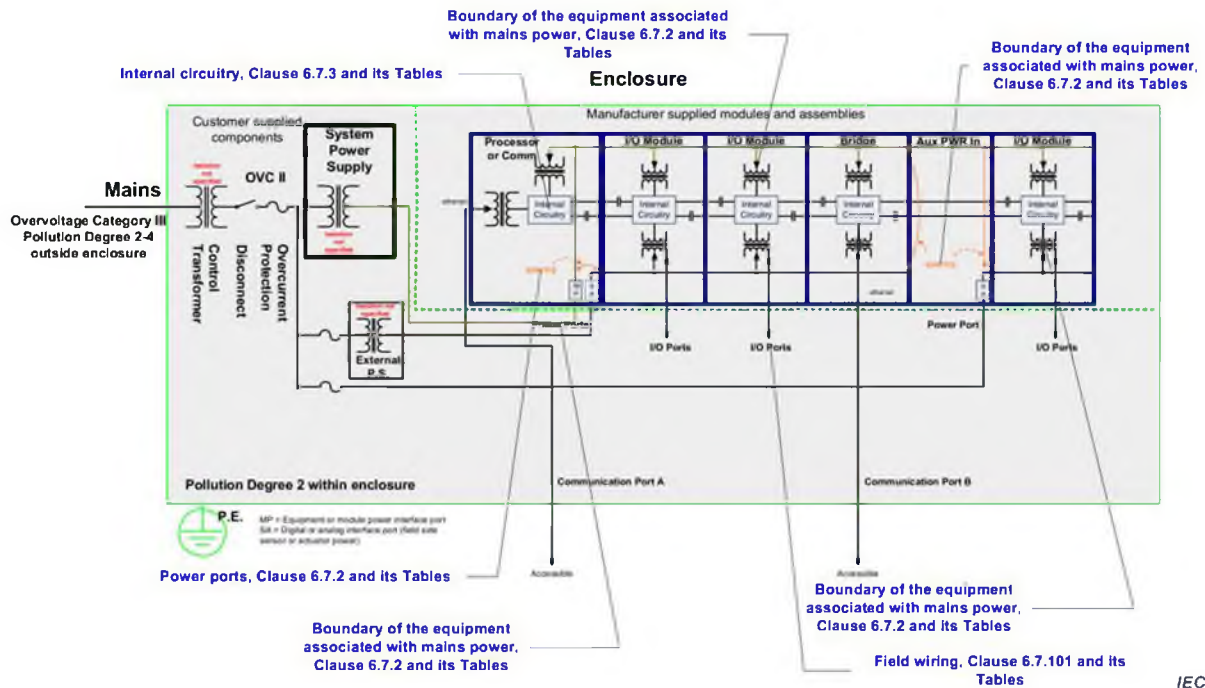

Figure BB.4 – Application of the standard to the control equipment safety drawing

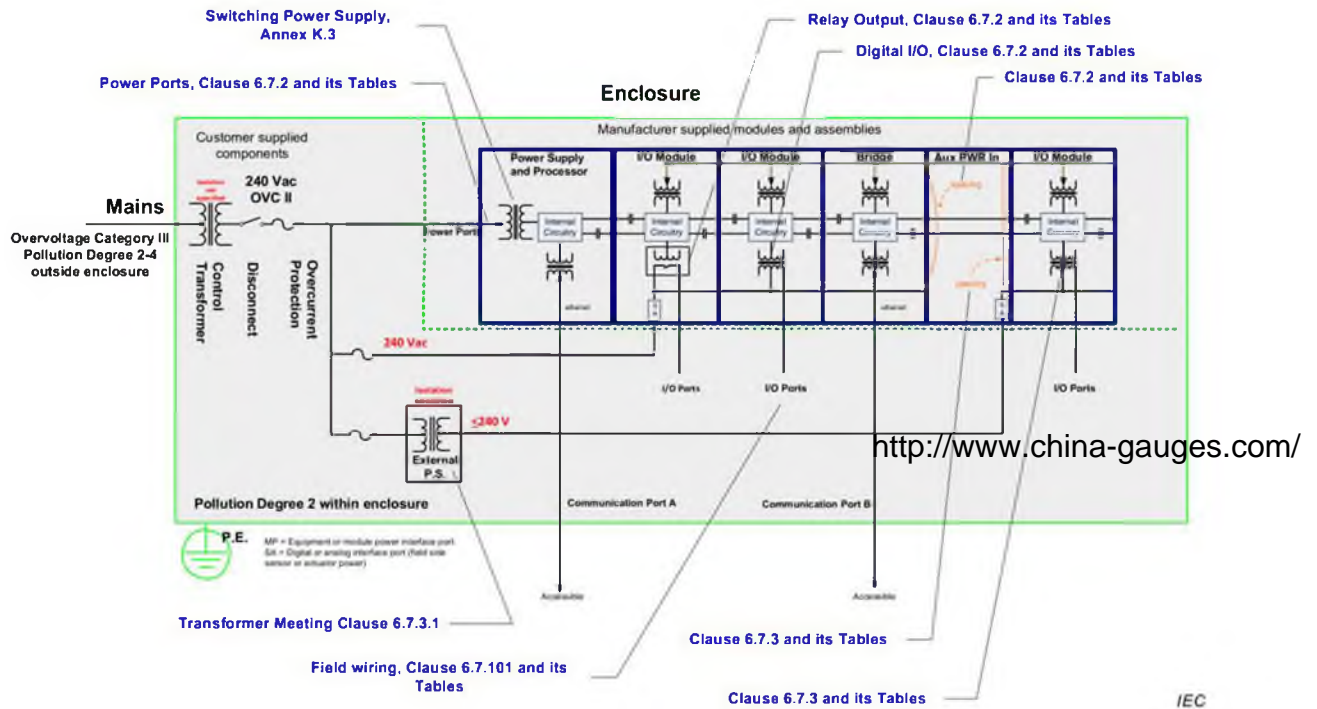

Figure BB.5 – Application of 6.7.1.5 items a) and b) to the control equipment safety drawing

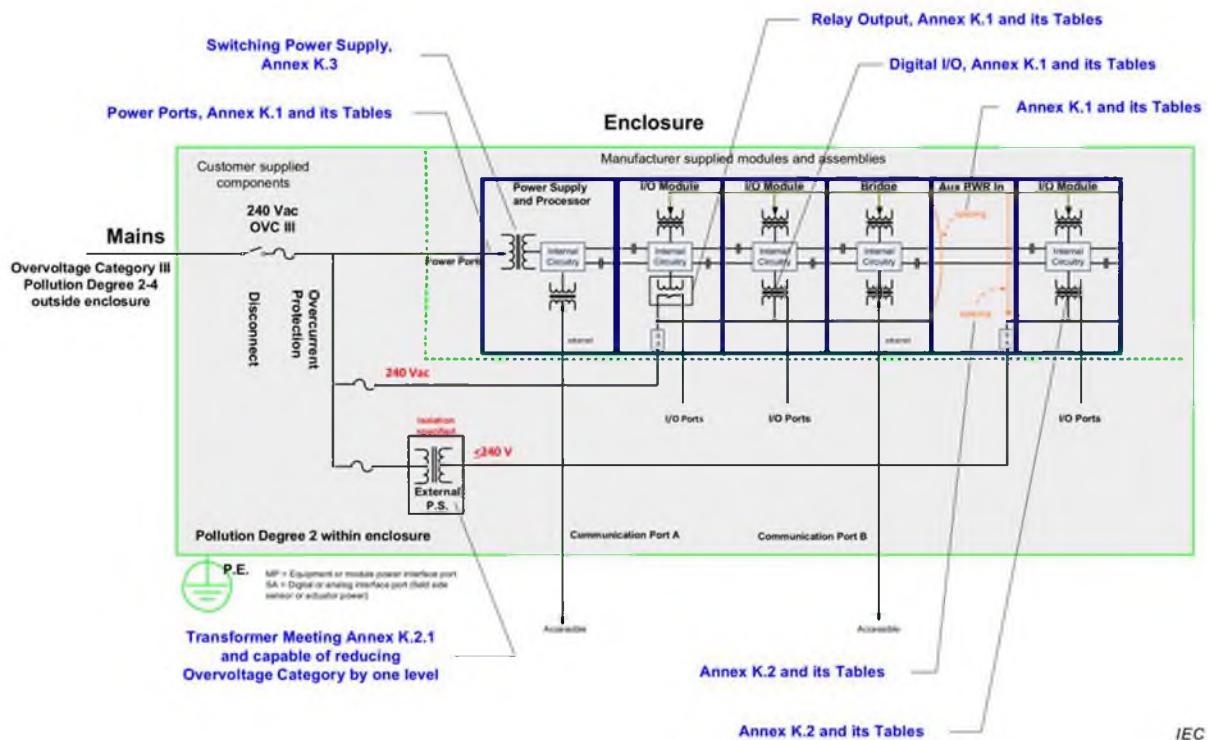

Figure BB.6 – Application of 6.7.1.5 items a), b), c) and d) to the control equipment safety drawing

For this standard, the equipment shall be safe under normal and SINGLE FAULT CONDITION. Some examples of different methodologies to make the schematic in Figure BB.3 safe methods are now presented.

Referring to Figure BB.7, REINFORCED INSULATION provides the method to handle single faults and maintain safety.

REINFORCED INSULATION at I/O and module power makes the ACCESSIBLE communication ports SELV/PELV.

Communication connections can utilize functional insulation, as they are not required to provide any protection.

<http://www.china-gauges.com/>

As such a single fault at any connection cannot propagate to cause communication connections to become hazardous.

Implementation of the associated safety methods in this example makes the use of SELV/PELV as a protection method unnecessary, but still permissible.

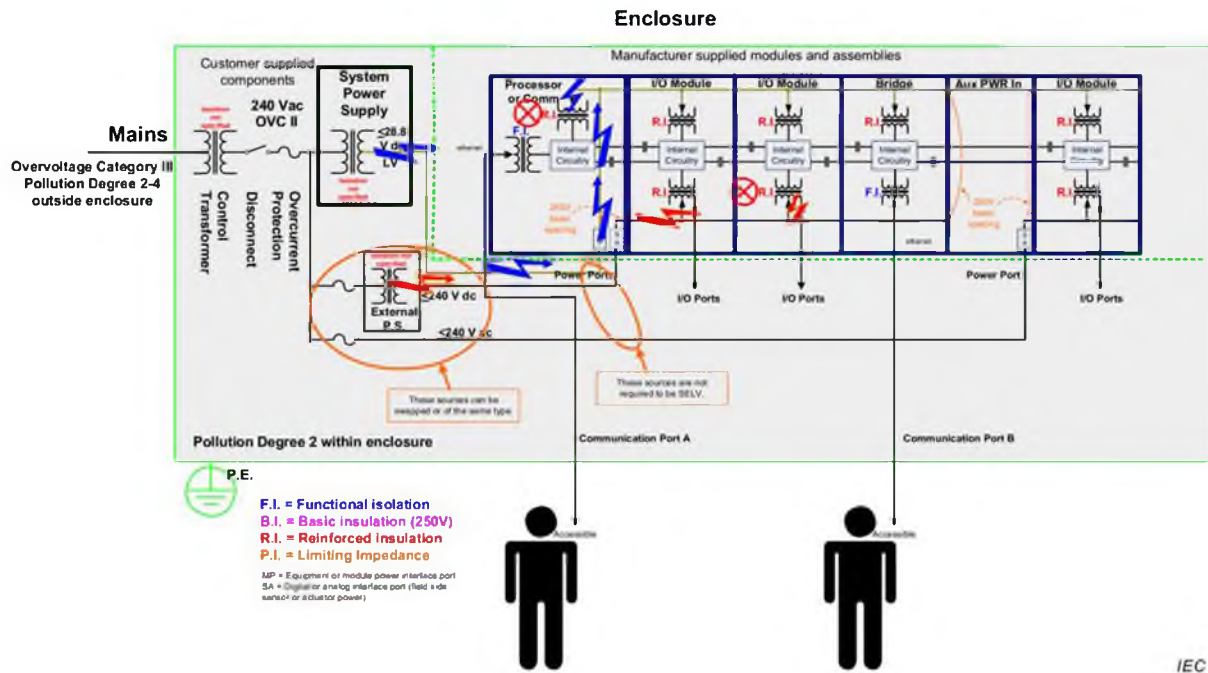

Figure BB.7 – REINFORCED INSULATION

Referring to Figure BB.8, BASIC INSULATION provides the method to handle single faults and maintain safety.

BASIC INSULATION is provided at all connections. One failure of a BASIC INSULATION is allowed, but a second level of BASIC INSULATION is always present.

As such a single fault at any connection cannot propagate to cause communication connections to become hazardous.

Implementation of the associated safety methods in this example makes the use of SELV/PELV as a protection method unnecessary, but still permissible.

<http://www.china-gauges.com/>

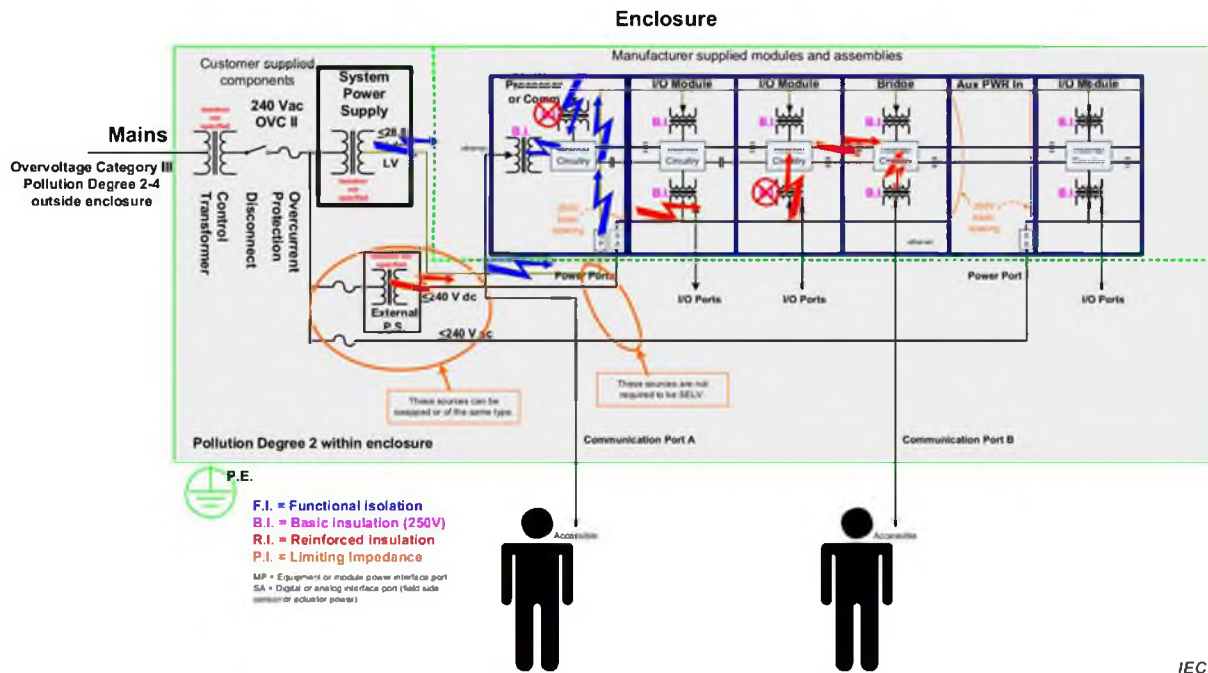

IEC

Figure BB.8 – BASIC INSULATION

Referring to Figure BB.9, REINFORCED INSULATION, BASIC INSULATION and PROTECTIVE IMPEDANCE provide the method to handle single faults and maintain safety.

REINFORCED INSULATION is provided at module power. PROTECTIVE IMPEDANCE, by inter-module capacitors, and basic (supplementary) insulation is provided at the I/O.

Communication connections can be functional insulation, as they are not required to provide any protection.

As such a single fault at any connection cannot propagate to cause communication connections to become hazardous.

Implementation of the associated safety methods in this example makes the use of SELV/PELV as a protection method unnecessary, but still permissible.

<http://www.china-gauges.com/>

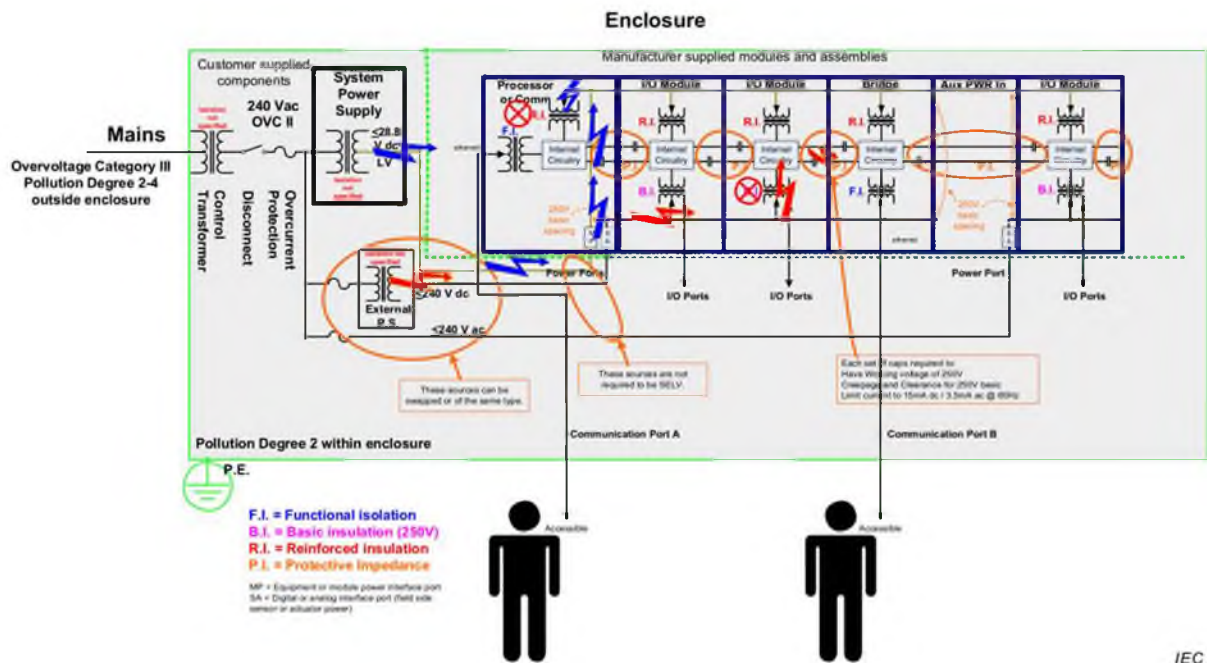

Figure BB.9 – REINFORCED INSULATION, BASIC INSULATION and PROTECTIVE IMPEDANCE

Referring to Figure BB.10, external power supplies provide REINFORCED INSULATION with SELV/PELV output levels and hence provide the method to handle single faults and maintain safety.

I/O, communication connections can be functional insulation, as they are not required to provide any protection.

REINFORCED INSULATION is necessary wherever any non-SELV/PELV power is applied, e.g. AC I/O.

As such a single fault at any connection cannot propagate to cause communication connections to become hazardous.

<http://www.china-gauges.com/>

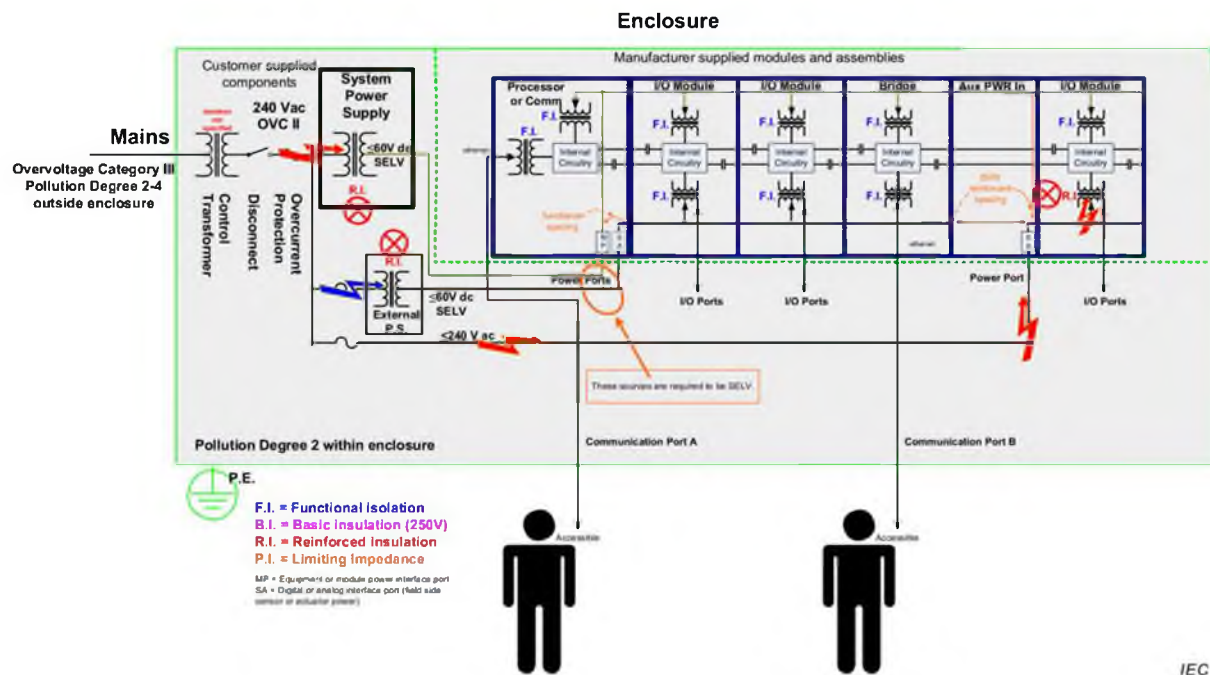

Figure BB.10 – REINFORCED INSULATION from external power supplies

Referring to Figure BB.11, external power supplies provide BASIC INSULATION and hence provide a method to handle single faults and maintain safety.

BASIC INSULATION is also provided at all connections I/O. One failure of a BASIC INSULATION at the power supplies is allowed, but a second level of BASIC INSULATION is always present, at the I/O.

PROTECTIVE IMPEDANCE, by inter-module capacitors, and BASIC INSULATION can also be provided at the I/O. In this way a first failure is protected against.

Communication connections can be functional insulation, as they are not required to provide any protection.

As such a single fault at any connection cannot propagate to cause communication connections to become hazardous. <http://www.china-gauges.com/>

Implementation of the associated safety methods in this example makes the use of SELV/PELV as a protection method unnecessary, but still permissible.

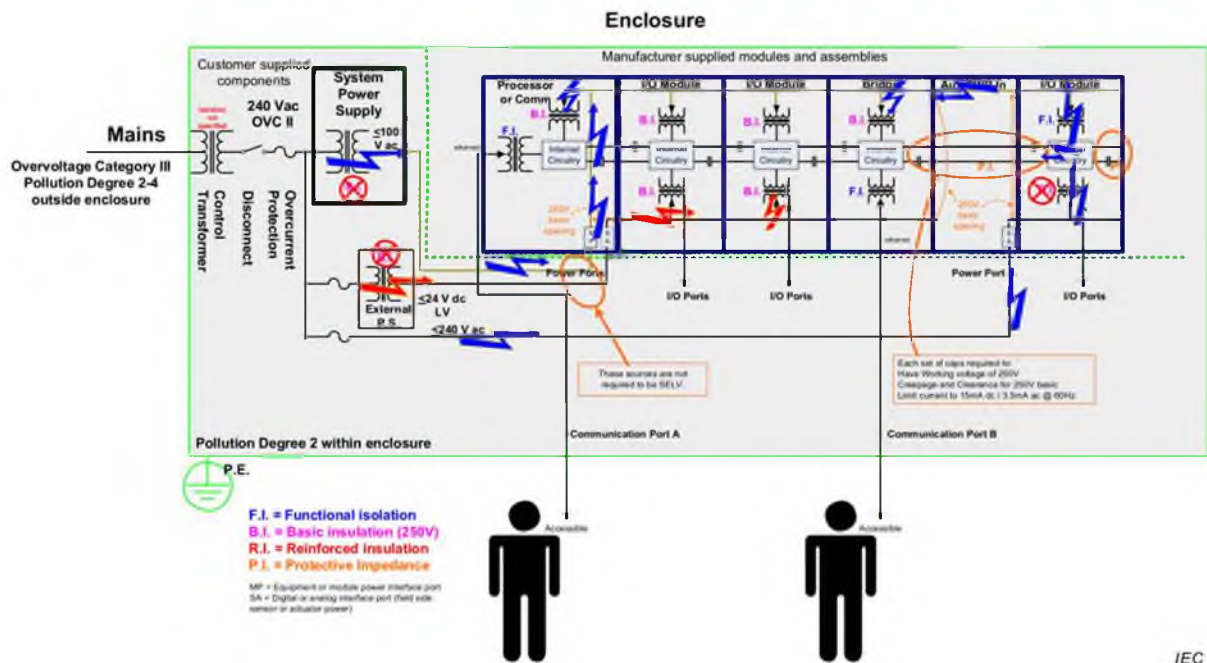

Figure BB.11 – BASIC INSULATION from external power supplies

These five scenarios are just a few of many which can be the basis of a control system electrical safety.

Whatever the method chosen, it is recommended it be documented in a drawing, such as shown here.

BB.5 Conclusion

The development of a control equipment electrical safety drawing is invaluable in understanding and communicating the electrical safety and isolation in a system as it is developed. This can keep all parties involved in the original certification, as well as future participants making additions to an expandable system, on a consistent path.

<http://www.china-gauges.com/>

Annex CC (informative)

Historical techniques for secondary circuits

CC.1 Secondary circuits background

Annex CC is meant to describe a set of circuits utilized historically in control equipment. These techniques are not recommended for new designs. Newer techniques have been devised and accepted into common practice eliminating the need for these circuits.

This annex is an overview and is not meant to be a complete description of these circuits, the techniques nor the requirements and conditions to utilize them. For a complete set of information on these circuits, see UL 508.

The circuits listed offered two areas of effect: controlling the provisions against electric shock and against spread of fire.

CC.2 Secondary circuits without RISK of electrical shock

CC.2.1 General

The following secondary circuits also do not pose a RISK of electrical shock and do not require additional evaluation for RISK against electrical shock:

- a) class 2 circuit;
- b) limited voltage/current circuit;
- c) limited voltage circuit;
- d) limited energy circuit that involves open circuit potential less than or equal to 30 V AC or 42,4 V peak;
- e) limiting impedance circuit.

These circuits are described in CC.2.2.1, CC.2.2.2, CC.2.2.3, CC.2.2.4 and CC.2.2.5.

CC.2.2 Secondary circuits which do not pose a RISK of electrical shock

CC.2.2.1 Class 2 circuit

<http://www.china-gauges.com/>

A Class 2 circuit shall be supplied by an isolating source, providing DOUBLE INSULATION or REINFORCED INSULATION, which has a maximum output voltage of 42,4 V peak (sinusoidal or non-sinusoidal AC) or 60 V for continuous DC or 24,8 V peak for DC interrupted at a rate of 200 Hz or less with approximately 50 % duty cycle.

The maximum output current of a Class 2 source depends on whether it is inherently limited or not inherently limited. For inherently limited sources, Table CC.1 applies. For not inherently limited sources, Table CC.2 applies.

CC.2.2.2 Limited voltage/current circuit

A limited voltage/current circuit shall be supplied by an isolating source, providing DOUBLE or REINFORCED INSULATION, in such a way that the maximum open-circuit voltage available to the circuit is not more than AC 30 V r.m.s. and 42,4 V peak and the current available is limited to a value not exceeding 8 A measured after 1 min of operation.

The secondary winding of an isolating type transformer may be used to comply with this requirement.

A secondary fuse or other such secondary circuit protective device used to limit the available current shall be RATED at no more than 5,0 A for a circuit RATED less than, or equal to, 20 V peak, or 100 VA for a circuit RATED from 20 V to 30 V peak.

If the current-limiting device is provided in the MAINS CIRCUIT, there are no restrictions on its current RATING as long as it limits the available secondary current to 8 A.

CC.2.2.3 Limited voltage circuit

A limited voltage circuit shall be supplied by an isolating source, providing DOUBLE or REINFORCED INSULATION, with a maximum open-circuit voltage of not more than AC 30 V r.m.s. and 42,4 V peak without any limitation on the available current or volt-ampere capacity.

Overcurrent protection shall be provided to protect against burnout and damage to the secondary circuit cables/wiring insulation resulting from any overload or short-circuit condition. This protection may alternately be provided in the MAINS CIRCUIT by overcurrent protective devices provided with the control equipment or by branch circuit devices.

CC.2.2.4 Limited energy circuit which involves open-circuit potential less than, or equal to, AC 30 V r.m.s. and 42,4 V peak

A limited energy circuit shall be supplied by an isolating source, providing DOUBLE or REINFORCED INSULATION, in such a way that the maximum volt-ampere capacity available to the circuit is 200 VA or less at a maximum open-circuit voltage of less than or equal to AC 30 V r.m.s. and 42,2 V peak. The secondary winding of an isolating type transformer may be used to comply with this requirement. A primary or secondary fuse or other circuit protective device may be used to limit the maximum volt-ampere capacity.

CC.2.2.5 Limiting impedance circuit

A limiting impedance circuit shall be supplied by an impedance that complies with the following two requirements:

- a) the calculated power dissipation of the impedance, as the result of a direct short applied across the circuit downstream of the impedance, does not exceed the power RATING of the impedance, and
- b) the power dissipated in the impedance shall be less than 15 W.

If the above calculated power dissipation exceeds the RATING of the impedance, the impedance may still be used if the power is less than 15 W and if the impedance does not open or short when subjected to a direct short applied across the <http://www.china-gauges.com/> impedance.

The limiting impedance shall be able to function under SINGLE FAULT CONDITION unless the circuit limited by the impedance is enclosed.

A single resistor, or a single across-the-line capacitor approved per 14.101.1, is considered to comply with this limiting impedance requirement.

CC.3 Secondary circuits without RISK of spread of fire

CC.3.1 General

The following secondary circuits also do not pose a RISK of spread of fire and do not require additional evaluation for RISK of spread of fire:

- a) class 2 circuit;
- b) limited voltage/current circuit;

- c) limiting impedance circuit;
- d) limited power circuit.

CC.3.2 Secondary circuits which do not pose a RISK of spread of fire

CC.3.2.1 Class 2 circuit

See CC.2.2.1.

CC.3.2.2 Limited voltage/current circuit

See CC.2.2.2.

CC.3.2.3 Limiting impedance circuit

See CC.2.2.5.

CC.3.2.4 Limited power circuit

A limited power circuit is a circuit supplied by sources such as a battery or a transformer winding where the open-circuit potential is not more than AC 30 V r.m.s. and 42,4 V peak or DC 60 V, and the energy available to the circuit is limited according to one of the following means:

- a) the maximum output current and power are inherently limited to not more than the values of Table CC.1;
- b) the maximum output current under all conditions and power are limited by impedance to be not more than the values of Table CC.1;
- c) an over-current protective device limits the maximum output current and power to not more than the values of Table CC.2;
- d) a regulating network limits the maximum output current and power to not more than the values of Table CC.1 in NORMAL USE or as a result of one fault in the regulating network; or
- e) a regulating network limits the maximum output current and power to not more than the values of Table CC.1 in NORMAL USE, and an over-current protective device limits the output current and power to not more than the values of Table CC.2 as the result of any one fault in the regulating network.

Where an over-current protective device is used, it shall be a fuse or a non-adjustable non-self-resetting device.

<http://www.china-gauges.com/>

**Table CC.1 – Limits of output current and output power
for inherently limited power sources**

Open-circuit output voltage U		Maximum output current A	Maximum output power $V \times A$
AC V r.m.s.	DC V		
≤ 20	≤ 20	8,0	$5 \times U$
$20 < U \leq 30$	$20 < U \leq 30$	8,0	100
	$30 < U \leq 60$	$150/U$	100

For non-sinusoidal AC and for DC with ripple exceeding 10 %, the peak voltage shall not exceed 42,4 V peak.

**Table CC.2 – Limits of output current, output power and RATINGS
for over-current protective devices for non-inherently limited power sources**

Open-circuit output voltage U		Maximum output current	Maximum output power	RATED current value of over-current protective device
AC V r.m.s.	DC V	A	V × A	A
≤ 20	≤ 20	$1\ 000/U$	250	≤ 5
$20 < U \leq 30$	$20 < U \leq 60$	$1\ 000/U$	250	$\leq 100/U$

RATED current values for over-current protective devices are for fuses and circuit-breakers which break the current within 120 s at a current value of 210 % of the value in the last column of Table CC.2.

Conformity is checked by measuring the output voltage, the maximum output current and the maximum available output power under the following conditions:

- 1) *output voltage is measured in no-load condition;*
- 2) *output current and available power are measured after 60 s of operation, with any over-current protective devices short-circuited, with a resistive load (including short-circuit) which produces the highest value of current and power respectively.*

<http://www.china-gauges.com/>

Annex DD (normative)

Flammability test for magnesium alloy fire ENCLOSURES or flame barriers (see 9.3.2)

DD.1 General

When magnesium alloy is used as a fire ENCLOSURE or a flame barrier, the flammability properties shall be determined to support the requirements of 9.3.2. The method described in Annex DD will demonstrate whether the material will ignite under typical conditions, and whether the flame, if it does ignite, will propagate long enough to cause a HAZARD of the spread of fire.

This method is similar to the method used for determining the flammability characteristics of plastics.

NOTE The test methods and conformance criteria of the 500 W Vertical Burning Test for plastic materials of ANSI/UL 94 are equivalent.

Conformity is checked as specified in Clause DD.2 to Clause DD.5. During the test and until 1 min after the last application of the test flame, the sample shall not ignite.

DD.2 Samples

One sample is tested, consisting of a complete fire ENCLOSURE or flame barrier.

DD.3 Mounting of samples

The sample is mounted and oriented as it would be in actual use.

DD.4 Test flame

The 500 W nominal test flame of IEC 60695-11-3 is used.

DD.5 Test procedure

<http://www.china-gauges.com/>

The test flame is applied to an inside surface of the sample at a minimum of three points and a maximum of five points, including the section of the sample where the material is the thinnest, sections of the sample where ventilation or other openings are located, and sections of the sample that are located near a source of ignition. If it is not possible to apply the flame to the inside surface, it may be applied to the outside surface.

If a vertical part is involved, the flame is applied at an angle of approximately 20° from the vertical. If ventilation or other openings are involved, the flame is applied to an edge of an opening, otherwise to a solid surface. In all cases, the tip of the inner blue cone of the flame is to be in contact with the sample.

The flame is applied to each point for 5 s, removed for 5 s, then reapplied again to the same point until a total of five applications have been made to this point. After that, the flame is removed for 60 s, and then applied in the same manner to the next test point on the sample.

Annex EE (informative)

Information/documentation and correlation to its uses

Annex EE is not a certification requirement. It is included only to depict one of many many examples of how industrial components are combined together to form a useful application. Other industries have a similar or the same work flow.

This example focuses on how information/documentation, regarding safety aspects, might flow through the development process of that useful application.

As shown in Figure EE.1, component products generally shall be combined together with other products to execute some useful application. As such, the information/documentation has more of an installer, service, system designer focus rather than an end use focus and need.

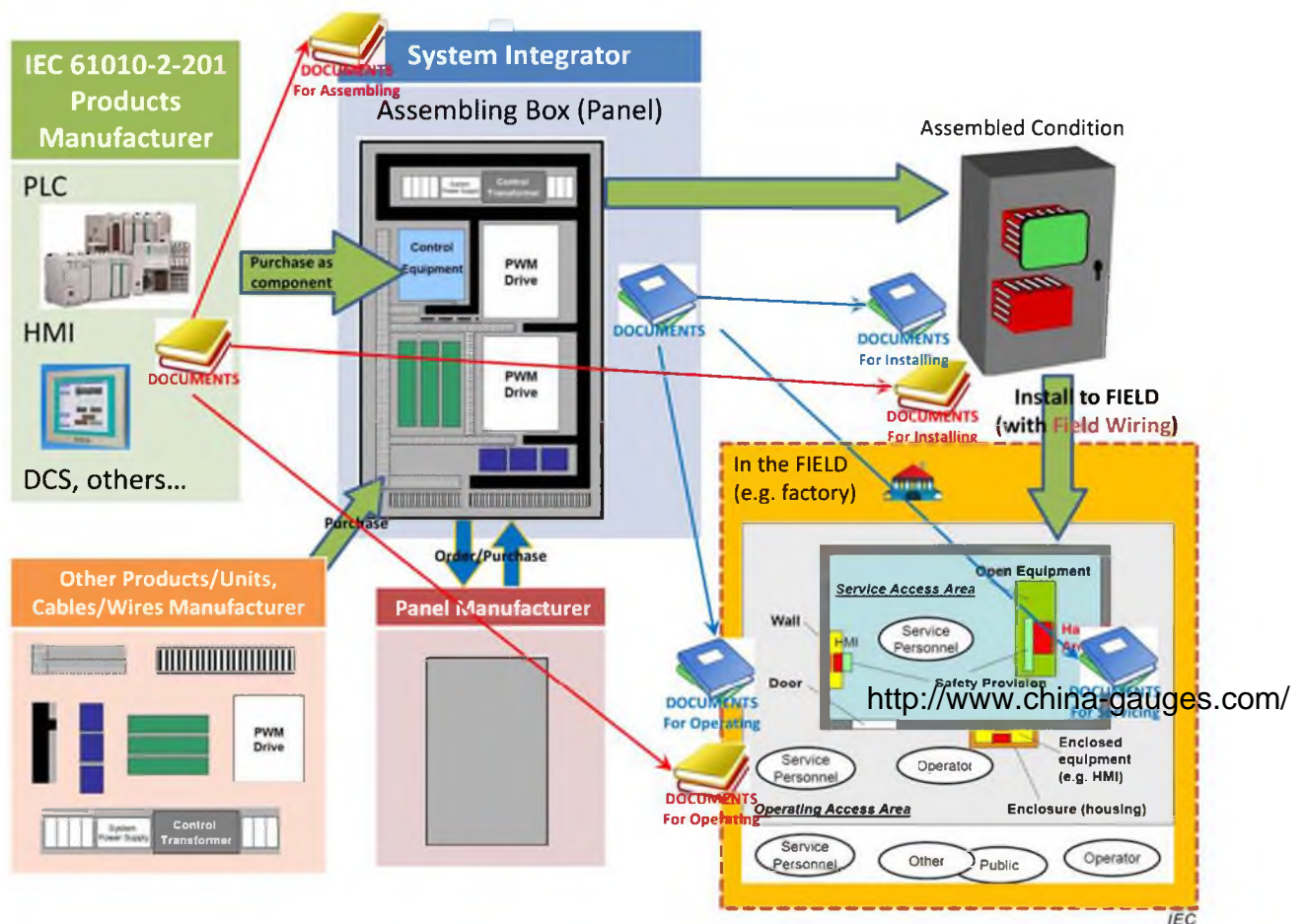

Figure EE.1 – Information/documentation for component products

Figure EE.2 shows an example of safety information as it is collected, selected and differentially compiled for different end uses, with regard to some certain installation.

On the left are the documentation sets provided by the component manufacturers. These may include safety information (the focus in the example), programming information, specification information, end-of-life recycling information, warranty information, etc.

Moving to the right, next those components may be utilized by panel manufacturers to build their part of the overall installation. They might select parts of the information from each to the component manufacturers to include in their safety information to reformat, include and pass on with their own panel safety information.

At the next stage, a system integrator selects, reformats, and passes on his safety information which the system owner requested or the integrator feels the owner will need.

Lastly then the system owner may again partition the information targeted at his OPERATORS and maintenance people.

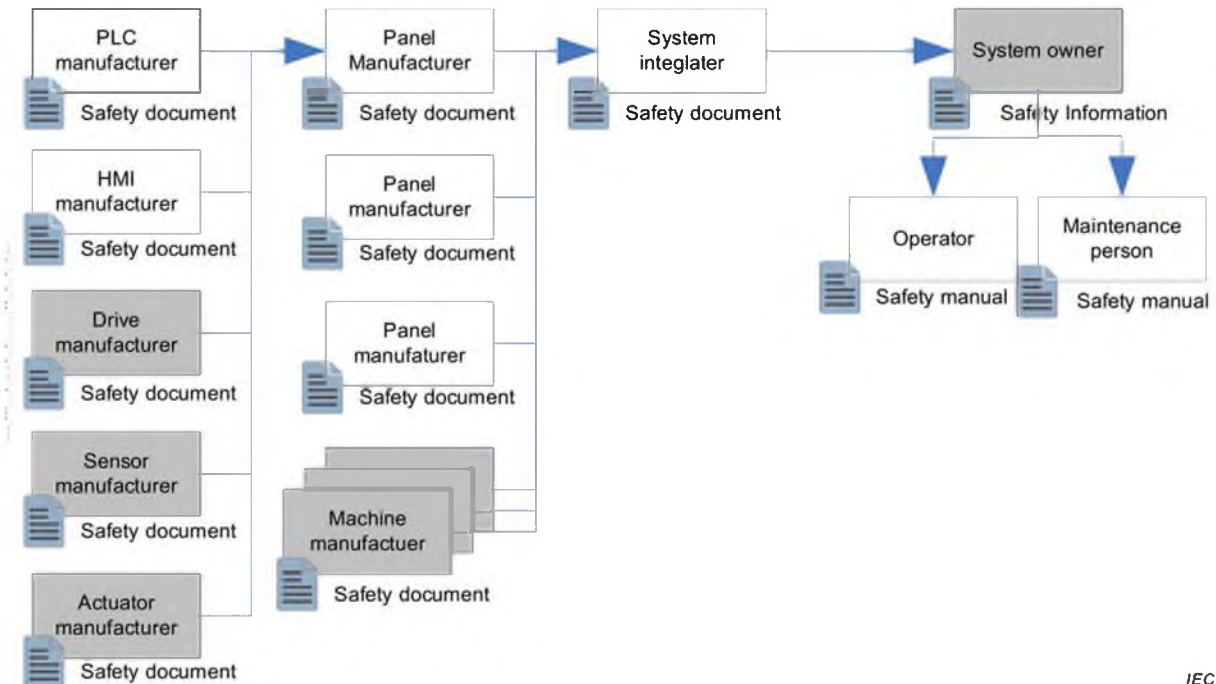

IEC

Figure EE.2 – Information/documentation accumulation and segregation tree for an example installation

This is one on many ways information/documentation of various types, threads its way from the manufacturer to the OPERATORS, maintenance personnel, etc.

<http://www.china-gauges.com/>

Annex FF (informative)

Measurement of CLEARANCES and CREEPAGE DISTANCES

The following examples complement those examples given in IEC 61010-1:2010, Annex C.

These examples are presented to enhance explanation of situations commonly found in control equipment. Very often they occur in the cases where surface mount devices (SMD) are utilized on printed wiring boards (PWBs). SMD devices present situations where there can be minimal or no distance between a component and the PWB. This brings into focus the question of which CLEARANCE and CREEPAGE rules apply with regard to the component of some material group (MG) and the PWB when the distance between component and PWB shrinks to minimal values.

The methods of measuring CLEARANCES and CREEPAGE DISTANCES are indicated in the following Figure FF.1 and Figure FF.2. These cases do not differentiate between gaps and grooves or between types of insulation.

The following assumptions are made:

- a) where the distance across a groove is equal to or larger than X (see Table FF.1), the CREEPAGE DISTANCE is measured along the contours of the groove (see Figure FF.1);
- b) any recess is assumed to be bridged with an insulating link having a length equal to X and being placed in the least favourable position (see Figure FF.2);
- c) CLEARANCES and CREEPAGE DISTANCES measured between parts which can assume different positions in relation to each other are measured when these parts are in their least favourable position.

In the following examples dimension X has the value given in Table FF.1 depending on the POLLUTION DEGREE.

Table FF.1 – Dimensions of X

POLLUTION DEGREE	Dimension X mm
1	0,25
2	1,0
3	1,5

<http://www.china-gauges.com/>

If the associated CLEARANCE is less than 3 mm, the dimension X in Table FF.1 may be reduced to one-third of this CLEARANCE.

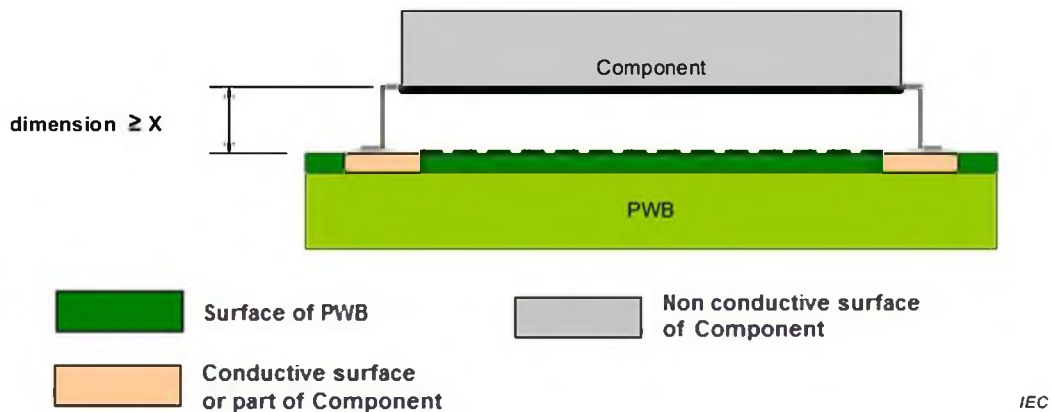

Figure FF.1 – The path a component mounted to a PWB (side view)

EXAMPLE Figure FF.1: The path a component mounted to a PWB (side view).

The CLEARANCE is the shortest direct air path across the top of the PWB.

The CREEPAGE DISTANCE follows the contour of the component, along the shortest path measured on any side of the component.

NOTE 1 When components have a lower MG value than the surface on which they are mounted, the critical distance can be along the surface of the component. If the surface of the component and the surface on which it is mounted have the same MG, the critical CREEPAGE DISTANCE can be the direct path along the surface of the PWB.

NOTE 2 The conductive contacts on a component might be positioned such that the shortest path might be above or beside the component, and not necessarily below the component as shown.

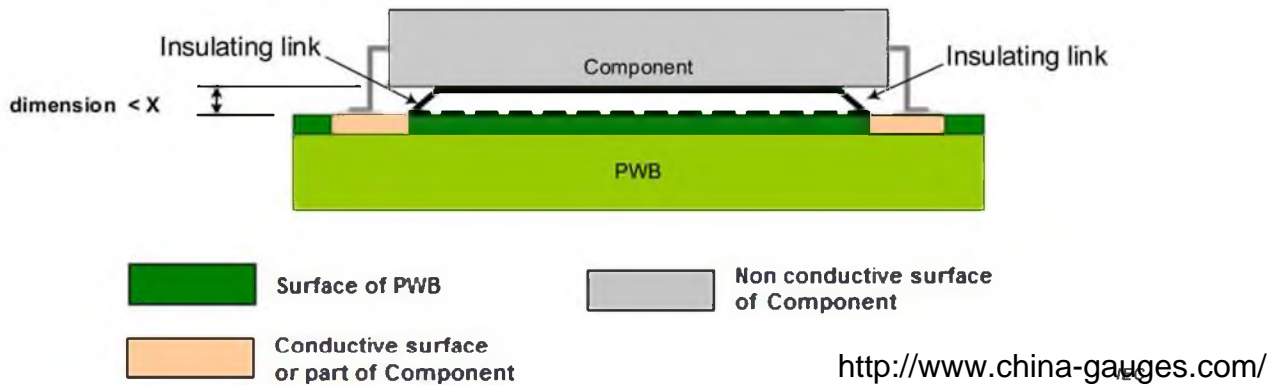

Figure FF.2 – The path a component mounted to a PWB (side view)

EXAMPLE Figure FF.2: The path a component mounted to a PWB (side view).

The CLEARANCE is the shortest direct air path across the top of the PWB.

The CREEPAGE DISTANCE follows the insulating links to the contour of the bottom of the component.

The MG of the various surfaces shall be taken into consideration.

NOTE 3 The measurement across the surface of the component starts where the link distance, value from Table FF.1, starting from the conductive contacts meets the surface of the component and continues to where the link distance from the opposite conductive contact meets the surface of the component.

NOTE 4 The conductive contacts on a component might be positioned such that the shortest path might be between these two contacts, or between one conductive contact and the conductive surface on the PWB surface, and not always between the two conductive surfaces on the PWB surface.

Bibliography

This bibliography of Part 1 is applicable, except as follows.

Addition:

IEC 60050 (all parts), *International Electrotechnical Vocabulary* (available at <http://www.electropedia.org>)

IEC 60079 (all parts), *Explosive atmospheres*

IEC 60364 (all parts), *Low-voltage electrical installations*

IEC 60364-4-41, *Low-voltage electrical installations – Part 4-41: Protection for safety – Protection against electric shock*

IEC 60664-5, *Insulation coordination for equipment within low-voltage systems – Part 5: Comprehensive method for determining clearances and creepage distances equal to or less than 2 mm¹*

IEC 60715, *Dimensions of low-voltage switchgear and controlgear – Standardized mounting on rails for mechanical support of electrical devices in switchgear and controlgear installations*

IEC 60721-2-3, *Classification of environmental conditions – Part 2-3: Environmental conditions appearing in nature – Air pressure*

IEC 61131-2:2007, *Programmable controllers – Part 2: Equipment requirements and tests*

IEC 61131-6, *Programmable controllers – Part 6: Functional safety*

IEC 61140, *Protection against electric shock – Common aspects for installation and equipment*

IEC 61326 (all parts), *Electrical equipment for measurement, control and laboratory use – EMC requirements*

IEC 61508 (all parts), *Functional safety of electrical/electronic/programmable electronic safety-related systems* <http://www.china-gauges.com/>

IEC 61643 (all parts), *Low-voltage surge protective devices*

IEC 61800 (all parts), *Adjustable speed electrical power drive systems*

IEC 62133, *Secondary cells and batteries containing alkaline or other non-acid electrolytes – Safety requirements for portable sealed secondary cells, and for batteries made from them, for use in portable applications*

IEC 62368 (all parts), *Audio/video, information and communication technology equipment*

IEC Guide 117, *Electrotechnical equipment – Temperatures of touchable hot surfaces*

¹ Withdrawn.

ANSI/UL 94, *Standard for Tests for Flammability of Plastic Materials for Parts in Devices and Appliances*

UL 508, *Standard for Industrial Control Equipment*

UL 1059, *Standard for Terminal Blocks*

UL 1642, *Standard for Lithium Batteries*

UL 2054, *Standard for Household and Commercial Batteries*

<http://www.china-gauges.com/>

British Standards Institution (BSI)

BSI is the national body responsible for preparing British Standards and other standards-related publications, information and services.

BSI is incorporated by Royal Charter. British Standards and other standardization products are published by BSI Standards Limited.

About us

We bring together business, industry, government, consumers, innovators and others to shape their combined experience and expertise into standards-based solutions.

The knowledge embodied in our standards has been carefully assembled in a dependable format and refined through our open consultation process. Organizations of all sizes and across all sectors choose standards to help them achieve their goals.

Information on standards

We can provide you with the knowledge that your organization needs to succeed. Find out more about British Standards by visiting our website at bsigroup.com/standards or contacting our Customer Services team or Knowledge Centre.

Buying standards

You can buy and download PDF versions of BSI publications, including British and adopted European and international standards, through our website at bsigroup.com/shop, where hard copies can also be purchased.

If you need international and foreign standards from other Standards Development Organizations, hard copies can be ordered from our Customer Services team.

Copyright in BSI publications

All the content in BSI publications, including British Standards, is the property of and copyrighted by BSI or some person or entity that owns copyright in the information used (such as the international standardization bodies) and has formally licensed such information to BSI for commercial publication and use.

Save for the provisions below, you may not transfer, share or disseminate any portion of the standard to any other person. You may not adapt, distribute, commercially exploit, or publicly display the standard or any portion thereof in any manner whatsoever without BSI's prior written consent.

Storing and using standards

Standards purchased in soft copy format:

- A British Standard purchased in soft copy format is licensed to a sole named user for personal or internal company use only.
- The standard may be stored on more than 1 device provided that it is accessible by the sole named user only and that only 1 copy is accessed at any one time.
- A single paper copy may be printed for personal or internal company use only.
- Standards purchased in hard copy format:
- A British Standard purchased in hard copy format is for personal or internal company use only.
- It may not be further reproduced – in any format – to create an additional copy. This includes scanning of the document.

If you need more than 1 copy of the document, or if you wish to share the document on an internal network, you can save money by choosing a subscription product (see 'Subscriptions').

Reproducing extracts

For permission to reproduce content from BSI publications contact the BSI Copyright & Licensing team.

Subscriptions

Our range of subscription services are designed to make using standards easier for you. For further information on our subscription products go to bsigroup.com/subscriptions.

With **British Standards Online (BSOL)** you'll have instant access to over 55,000 British and adopted European and international standards from your desktop. It's available 24/7 and is refreshed daily so you'll always be up to date.

You can keep in touch with standards developments and receive substantial discounts on the purchase price of standards, both in single copy and subscription format, by becoming a **BSI Subscribing Member**.

PLUS is an updating service exclusive to BSI Subscribing Members. You will automatically receive the latest hard copy of your standards when they're revised or replaced.

To find out more about becoming a BSI Subscribing Member and the benefits of membership, please visit bsigroup.com/shop.

With a **Multi-User Network Licence (MUNL)** you are able to host standards publications on your intranet. Licences can cover as few or as many users as you wish. With updates supplied as soon as they're available, you can be sure your documentation is current. For further information, email subscriptions@bsigroup.com.

Revisions

Our British Standards and other publications are updated by amendment or revision.

We continually improve the quality of our products and services to benefit your business. If you find an inaccuracy or ambiguity within a British Standard or other BSI publication please inform the Knowledge Centre.

Useful Contacts

Customer Services

Tel: +44 345 086 9001

Email (orders): orders@bsigroup.com

Email (enquiries): cservices@bsigroup.com

<http://www.china-gauges.com/>

Subscriptions

Tel: +44 345 086 9001

Email: subscriptions@bsigroup.com

Knowledge Centre

Tel: +44 20 8996 7004

Email: knowledgecentre@bsigroup.com

Copyright & Licensing

Tel: +44 20 8996 7070

Email: copyright@bsigroup.com

BSI Group Headquarters

389 Chiswick High Road London W4 4AL UK